

PREMIUM DRIVE SHAFTS CATALOGUE 2024



GS[®]P

GSP AUTOMOTIVE GROUP



GSP Automotive Group is a leading manufacturer for automotive parts for the worldwide aftermarket. Since 1985, GSP continues to produce constant velocity joints, drive shafts, hub assemblies, rubber-to-metal parts as well as steering & suspension parts.

The GSP team supports over 120 countries and counting. With our diverse range of native professionals, we bring customer care and expertise to each market.

WIDE RANGE PRODUCTS

- 1 DRIVELINE
- 2 WHEEL BEARING
- 3 RUBBER TO METAL PART
- 4 STEERING & SUSPENSION PART
- 5 SHOCK ABSORBER
- 6 PROPSHAFT PART

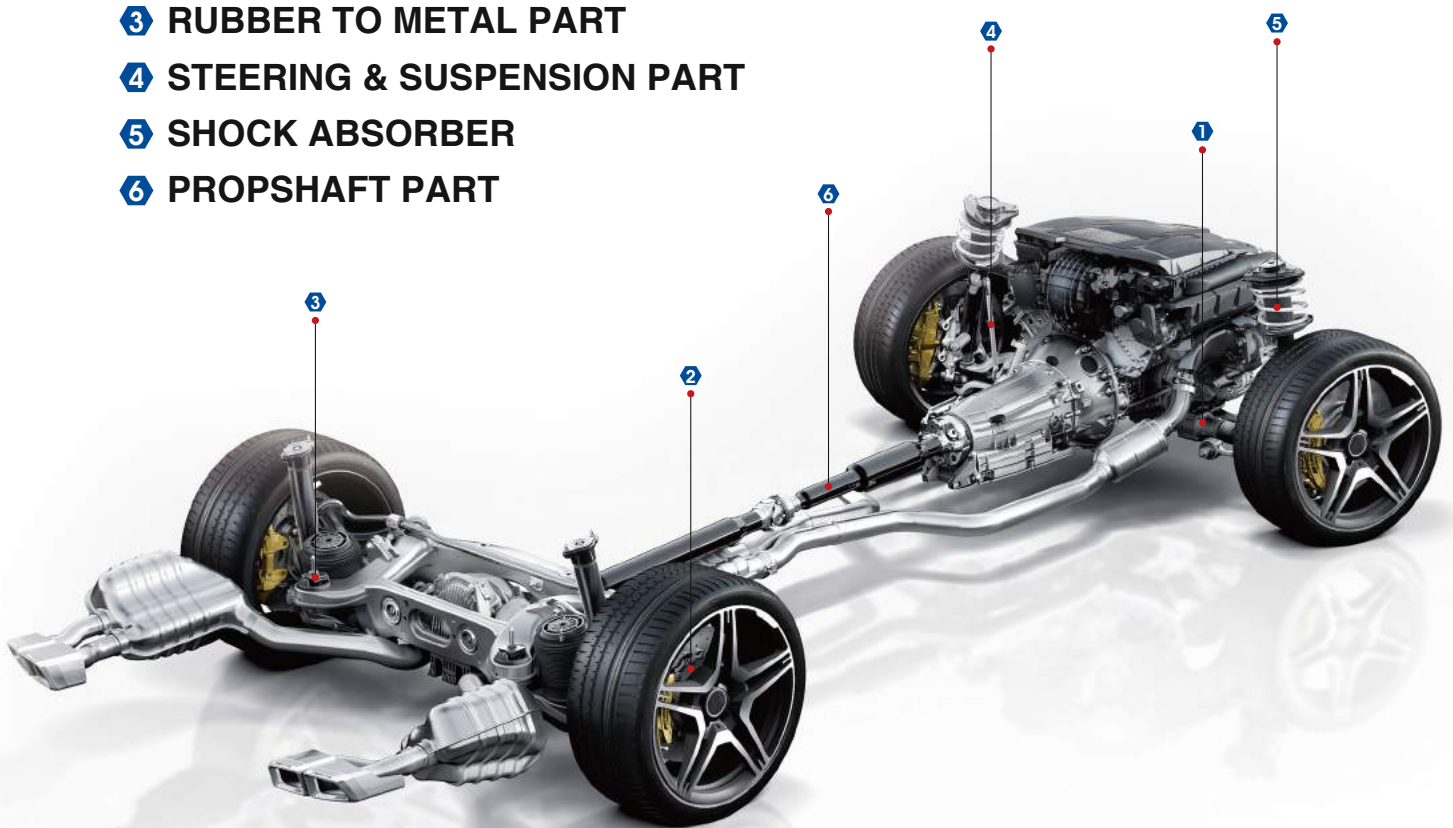

- Models covered over 95% of the worldwide automotive market
- One-stop solution for the automotive aftermarket
- Small batch sourcing with a variety of categories

WORLDWIDE LOCATION

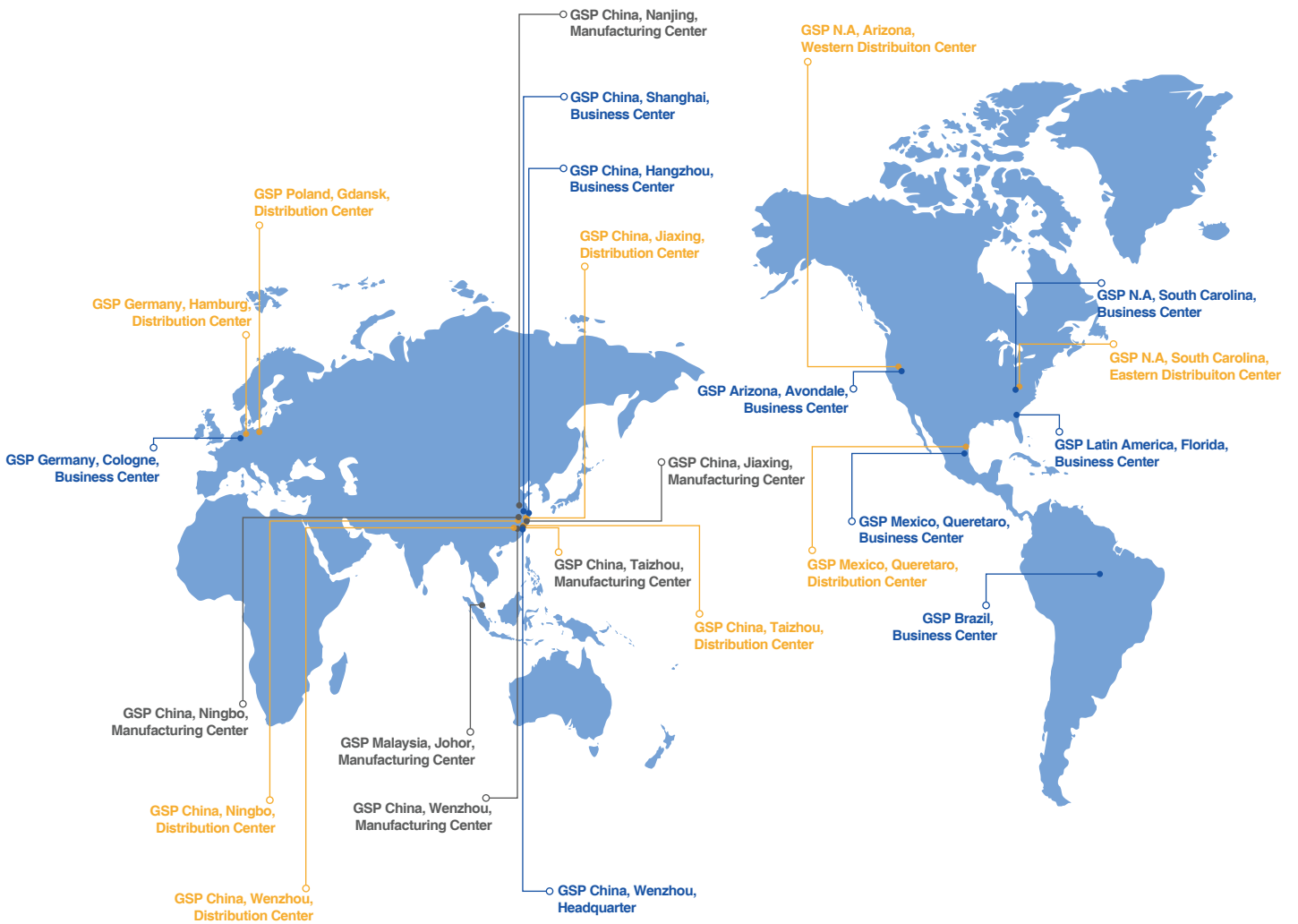

- Manufacturing Center
- Distribution Center
- Business Center

PREMIUM QUALITY



GSP has been certified by ISO 14001, ISO 45001 and IATF 16949, etc. With the strict screening and monitoring of the raw material, GSP is carrying out quality control on the whole product production process.

CUSTOMER SERVICES



Worldwide customer services teams support nine majority languages and provide localized service to customers.

Trackable data from raw material sourcing to sales that offered consistently services to each customer.



Drive Shafts

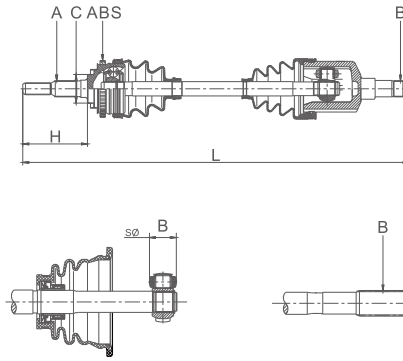

A: External Teeth, wheel side
 B: External Teeth, diff. side/
 Tripod roller Diameter
 C: Seal Diameter [mm]
 H: Bell pin length (wheel side)
 L: Length
 ABS: Number of teeth on ABS ring

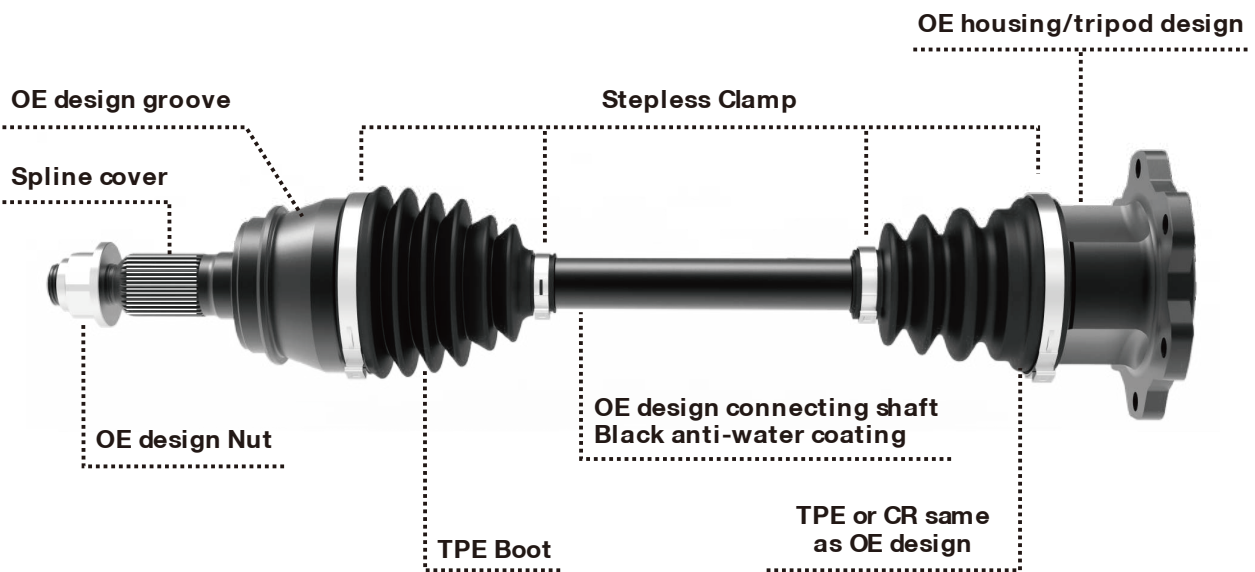

GSP Advantages:

1. 100% in-line with OE specifications for perfect installation and maximum performance, even under extreme working conditions.
2. TPE boots can prevent the deformation, wear, swelling and leakage.
3. High-performance grease provides better wear-resistance and rejection of heat.
4. OE-spec clamps to optimally tighten TPE or CR boot with 100% sealing and zero leakage.
5. All necessary service parts like nuts and bolts are included in the box.
6. Additional features like spline cover and seal protector to avoid damages during transport.

GENERAL INDEX





Vehicle Index	page.I-III
Application	page.001-162
Cross Reference List	page.163-168
New applications (compared with catalogue 2023)	page.169-169





MAKE-MODEL	PAGE	MAKE-MODEL	PAGE	MAKE-MODEL	PAGE
AUDI		BMW		BMW	
A3	1	214d Gran Tourer	22	328i Touring	29
A3 Cabrio	3	216d Active Tourer	22	328i xDrive	29
A3 Cabrio Quattro	4	216d Gran Tourer	22	328i xDrive Gran Turismo	29
A3 Quattro	4	216i Active Tourer	22	328i xDrive Touring	29
A3 Sportback	5	216i Gran Tourer	22	330d	29
A3 Sportback Quattro	7	218d Active Tourer	22	330d Coupe	29
A4	7	218d Cabrio	22	330d Touring	29
A4 Allroad Quattro	8	218d Coupe	22	330d xDrive	29
A4 Quattro	9	218d Gran Tourer	23	330d xDrive Coupe	29
A5	10	218d xDrive Active Tourer	23	330d xDrive Gran Turismo	29
A5 Cabrio	11	218d xDrive Gran Tourer	23	330d xDrive Touring	29
A5 Cabrio Quattro	11	218i Active Tourer	23	330e	29
A5 Quattro	11	218i Cabrio	23	330i	30
A5 Sportback	12	218i Coupe	23	330i Cabrio	30
A5 Sportback Quattro	12	218i Gran Coupe	23	330i Coupe	30
A6	13	218i Gran Tourer	23	330i Touring	30
A6 Allroad Quattro	13	220d Active Tourer	23	330i xDrive	30
A6 Quattro	13	220d Cabrio	23	330i xDrive Gran Turismo	30
A7 Sportback	14	220d Coupe	23	330i xDrive Touring	30
A7 Sportback Quattro	14	220d Gran Tourer	24	335d xDrive	30
A8	14	220d xDrive Active Tourer	24	335d xDrive Gran Turismo	30
A8 Quattro	14	220d xDrive Coupe	24	335d xDrive Touring	30
Q2	15	220d xDrive Gran Tourer	24	335i	30
Q3	15	220d xDrive Grand Coupe	24	335i Cabrio	30
Q3 Quattro	15	220i Active Tourer	24	335i Coupe	30
Q3 Sportback	16	220i Cabrio	24	335i Gran Turismo	30
Q3 Sportback Quattro	16	220i Coupe	24	335i Touring	31
Q5	16	220i Gran Tourer	24	335i xDrive	31
Q5 Quattro	16	225e xDrive Active Tourer	24	335i xDrive Coupe	31
Q7 Quattro	17	225i Active Tourer	24	335i xDrive Gran Turismo	31
Q8 Quattro	17	225i xDrive Active Tourer	24	335i xDrive Touring	31
RS3 Quattro	17	228i Cabrio	24	340i xDrive	31
RS3 Sportback Quattro	17	228i Coupe	24	340i xDrive Gran Turismo	31
RS4 Quattro	17	230i Cabrio	25	340i xDrive Touring	32
RS5 Quattro	17	230i Coupe	25	418d Coupe	32
RS5 Sportback Quattro	17	3 ActiveHybrid	25	418d Gran Coupe	32
RS6 Quattro	17	316d	25	418i Coupe	32
RS7 Sportback Quattro	17	316d Touring	25	418i Gran Coupe	32
RSQ3 Quattro	17	316i	25	420d Cabrio	32
RSQ3 Sportback Quattro	18	316i Touring	25	420d Coupe	32
S3 Quattro	18	318d	25	420d Gran Coupe	32
S3 Sportback Quattro	18	318d Gran Turismo	25	420d xDrive Coupe	32
S4 Quattro	18	318d Touring	25	420d xDrive Gran Coupe	33
S5 Cabrio Quattro	18	318d xDrive	25	420i Cabrio	33
S5 Quattro	18	318d xDrive Touring	25	420i Coupe	33
S5 Sportback Quattro	18	318i	26	420i Gran Coupe	33
S6 Quattro	18	318i Touring	26	420i xDrive Coupe	33
S7 Sportback Quattro	18	320d	26	420i xDrive Gran Coupe	34
S8 Plus Quattro	18	320d Cabrio	26	428i Cabrio	34
S8 Quattro	18	320d Gran Turismo	26	428i Gran Coupe	34
SQ5 Quattro	18	320d Touring	26	428i xDrive Cabrio	34
TT	18	320d xDrive	26	428i xDrive Coupe	34
TT Quattro	19	320d xDrive Coupe	27	428i xDrive Gran Coupe	34
TTRS Quattro	19	320d xDrive Gran Turismo	27	430d xDrive Coupe	34
TTS Quattro	19	320d xDrive Touring	27	430d xDrive Gran Coupe	34
BMW		320i	27	430i Cabrio	34
114d	19	320i Gran Turismo	27	430i Coupe	34
114i	19	320i Touring	28	430i Gran Coupe	34
116d	20	320i xDrive	28	430i xDrive Cabrio	34
116i	20	320i xDrive Gran Turismo	28	430i xDrive Coupe	34
118d	20	320i xDrive Touring	28	430i xDrive Gran Coupe	34
118d xDrive	20	325d	28	435d xDrive Cabrio	35
118i	20	325d Cabrio	28	435d xDrive Coupe	35
120d	21	325d Coupe	28	435d xDrive Gran Coupe	35
120d xDrive	21	325d Touring	28	435i Cabrio	35
120i	21	325i	28	435i Coupe	35
123d	21	325i Cabrio	28	435i Gran Coupe	35
123d Cabrio	21	325i Coupe	28	435i xDrive Cabrio	35
123d Coupe	22	325i Touring	28	435i xDrive Coupe	35
125i	22	325i xDrive	29	435i xDrive Gran Coupe	35
130i	22	325i xDrive Coupe	29	440i xDrive Cabrio	35
135i Cabrio	22	325i xDrive Touring	29	440i xDrive Coupe	35
135i Coupe	22	328i	29	440i xDrive Gran Coupe	36
214d Active Tourer	22	328i Gran Turismo	29	5 ActiveHybrid	36



MAKE-MODEL	PAGE	MAKE-MODEL	PAGE	MAKE-MODEL	PAGE
BMW		BMW		FORD	
518d	36	X2 sDrive 18d	45	Transit Custom 320	57
518d Touring	36	X2 sDrive 18i	45	Transit Custom 330	57
520d	36	X2 sDrive 20d	45	Transit Custom 340	58
520d Touring	37	X2 sDrive 20i	45	FORD USA	
520d xDrive	37	X2 xDrive 18d	45	Ranger	58
520d xDrive Touring	38	X2 xDrive 20d	45	HONDA	
520i	38	X2 xDrive 20i	45	CR-V	58
520i Touring	38	X2 xDrive 25d	45	LAND ROVER	
523i	38	X2 xDrive M35i	45	Defender 110	58
523i Touring	39	X3 sDrive 20i	45	Defender 130	59
525d	39	X3 xDrive 20d	45	Defender 90	59
525d Touring	39	X3 xDrive 20i	46	Discovery	59
525d xDrive	39	X3 xDrive 28i	46	Discovery Sport	60
525d xDrive Touring	39	X3 xDrive 30d	46	Range Rover	61
528i	39	X3 xDrive 35d	46	Range Rover Evoque	61
528i Touring	39	X3 xDrive 35i	46	Range Rover Sport	62
528i xDrive	39	X4 xDrive 20d	46	LEXUS	
528i xDrive Touring	40	X4 xDrive 20i	46	ES 350	63
530d	40	X4 xDrive 28i	46	GX 460	63
530d Touring	40	X4 xDrive 30d	47	GX 470	63
530d xDrive	40	X4 xDrive 35d	47	MAN	
530d xDrive Gran Turismo	40	X4 xDrive 35i	47	TGE 2.140	63
530d xDrive Touring	40	X4 xDrive M40i	47	TGE 2.180	63
530i	40	X5	47	TGE 3.140	63
530i Touring	40	X5 M	47	TGE 3.180	63
535d	40	X5 xDrive 25d	47	TGE 4.140	64
535d Touring	40	X5 xDrive 28i	48	TGE 4.180	64
535d xDrive	40	X5 xDrive 30d	48	MERCEDES-BENZ	
535d xDrive Gran Turismo	41	X5 xDrive 30i	48	A160	64
535d xDrive Touring	41	X5 xDrive 35d	48	A180	64
535i	41	X5 xDrive 35i	48	A200	65
535i Touring	41	X5 xDrive 40d	49	A220	65
535i xDrive	41	X5 xDrive 40e	49	A250	65
535i xDrive Gran Turismo	41	X5 xDrive 40i	49	A45 AMG	65
535i xDrive Touring	41	X5 xDrive 48i	49	B160	65
550i	41	X5 xDrive 50i	49	B180	65
550i Touring	41	X5 xDrive M50d	49	B200	66
550i xDrive	41	X6 ActiveHybrid	49	B220	66
550i xDrive Gran Turismo	41	X6 M	49	B250	66
640d xDrive Cabrio	41	X6 xDrive 28i	49	C160	66
640d xDrive Coupe	41	X6 xDrive 30d	49	C180	66
640d xDrive Gran Coupe	41	X6 xDrive 35d	50	C200	66
640i xDrive Cabrio	41	X6 xDrive 35i	50	C220	67
640i xDrive Coupe	42	X6 xDrive 40d	50	C250	67
640i xDrive Gran Coupe	42	X6 xDrive 40i	50	C300	68
650i xDrive Cabrio	42	X6 xDrive 50i	50	C320	68
650i xDrive Coupe	42	X6 xDrive M50d	51	C350	68
650i xDrive Gran Coupe	42	CUPRA		C400	68
730d xDrive	42	Born	51	C43 AMG	68
740d xDrive	42	Formentor	51	C450 AMG	69
740i xDrive	42	FIAT		C63 AMG	69
750d xDrive	42	Fullback	51	CL500	69
750i xDrive	42	Talento	51	CLA180	69
i3	42	FORD		CLA200	69
M135i xDrive	42	Focus	51	CLA220	69
M140i xDrive	42	Focus Estate/Wagon	52	CLA250	69
M235i xDrive Cabrio	43	Galaxy	52	CLS220	70
M235i xDrive Coupe	43	Galaxy Van	52	CLS350	70
M240i xDrive Cabrio	43	Mondeo	52	CLS400	70
M240i xDrive Coupe	43	Mondeo Estate/Wagon	52	CLS500	70
M550d xDrive	43	S-Max	52	CLS63 AMG	70
M550d xDrive Touring	43	Tourneo Custom	53	E180	70
X1 sDrive 16d	43	Transit 290	53	E200	70
X1 sDrive 18d	43	Transit 310	53	E220	70
X1 sDrive 18i	43	Transit 330	54	E250	71
X1 sDrive 20d	43	Transit 350	55	E300	71
X1 sDrive 20i	43	Transit 410	55	E350	71
X1 xDrive 18d	43	Transit Custom 250	56	E400	71
X1 xDrive 20d	44	Transit Custom 260	56	E500	71
X1 xDrive 20i	44	Transit Custom 270	56	E63 AMG	71
X1 xDrive 23d	44	Transit Custom 280	56	GL320	71
X1 xDrive 25d	44	Transit Custom 290	56	GL350	72
X1 xDrive 25i	44	Transit Custom 300	56	GL400	72
X1 xDrive 28i	45	Transit Custom 310	57	GL420	72





MAKE-MODEL	PAGE	MAKE-MODEL	PAGE	MAKE-MODEL	PAGE
MERCEDES-BENZ		PORSCHE		VOLVO	
GL450	72	Cayenne	81	S80	108
GL500	72	Macan	82	S90	108
GL550	72	RENAULT		V60	108
GLA180	72	Trafic III	83	V60 Cross Country	109
GLA200	72	SAAB		V70	109
GLA220	72	9-5	83	V90	110
GLA250	72	SEAT		V90 Cross Country	110
GLC200	72	Alhambra	83	XC60	110
GLC220	73	Altea	84	XC90	112
GLC250	73	Altea Freetrack	85	VW	
GLC300	73	Altea XL	85	Amarok	112
GLC350	74	Ateca	87	Arteon	113
GLC400	74	Ibiza SC	87	Arteon Shooting Brake	113
GLC43 AMG	75	Leon	87	Beetle	113
GLE250	75	Leon SC	89	Bjalla	113
GLE350	75	Leon Sportstourer	90	Caddy	113
GLE400	75	Leon ST	90	CADDY ALLTRACK	117
GLE43 AMG	75	Tarraco	92	Caddy Alltrack	117
GLE450 AMG	75	Toledo	92	CADDY ALLTRACK	117
GLE500	75	SKODA		Caddy California	118
GLK200	75	Karoq	93	Caddy California Maxi	118
GLK220	75	Karoq Scout	93	Caddy Maxi	118
GLK250	75	Kodiaq	93	California	120
GLK350	75	Kodiaq Scout	93	Campmobile	122
GLS350	75	Octavia	93	Caravelle	123
GLS400	75	Octavia Scout	98	CC	126
GLS500	75	Superb	98	Crafter 30	126
MARCO POLO 160	75	Yeti	101	Crafter 35	127
MARCO POLO 170	75	SUZUKI		Eos	127
MARCO POLO 180	75	SX4	101	Golf	128
MARCO POLO 200	75	SX4 S-Cross	102	Golf Alltrack	133
ML250	75	Vitara	102	Golf Cabrio	133
ML280	75	TESLA		Golf Estate/Variant	133
ML300	75	Model 3	102	Golf Plus	136
ML320	76	Model S 100D	102	Golf Sportsvan	137
ML350	76	Model S 60	102	Golf Van (Variant)	138
ML400	76	Model S 60D	102	Grand California	139
ML420	76	Model S 70	102	ID.3	139
ML450	76	Model S 70D	102	Jetta	139
ML500	76	Model S 75	103	Multivan	140
ML550	76	Model S 75D	103	Passat	142
ML63 AMG	76	Model S 85	103	Passat Alltrack	145
S280	76	Model S 85D	103	Passat CC	146
S300	76	Model S 90D	103	Passat Estate/Variant	147
S320	76	Model S P100D	103	Scirocco	150
S350	76	Model S P85	103	Sharan	151
S400	76	Model S P85D	103	T-Roc	151
S450	76	Model S P90D	103	Tiguan	151
S500	76	Model X	104	Tiguan Allspace	153
SL350	76	Model X 100D	104	Touareg	153
SL400	76	Model X 60D	104	Touran	153
SL63 AMG	77	Model X 75D	104	Transporter	155
Vito 109	77	Model X 90D	104	Transporter Shuttle	161
Vito 110	77	Model X P100D	104	VW (FAW)	
Vito 111	77	Model X P90D	104	Magotan	162
Vito 114	77	TOYOTA			
MINI		Aurion	104		
Mini Clubman	77	Avalon	104		
Mini Cooper	78	Camry	104		
Mini Countryman	78	FJ Cruiser	104		
Mini One	78	Fortuner	105		
MITSUBISHI		Hilux	105		
L200	79	Land Cruiser	105		
Pajero Sport	79	Land Cruiser Prado	105		
NISSAN		Land Cruiser Van	105		
Navara	79	Rav 4	105		
NV300	79	VAUXHALL			
Pathfinder	80	Insignia	105		
OPEL		Insignia Country Tourer	106		
Insignia	80	Insignia Sports Tourer	106		
Insignia Country Tourer	80	Vivaro	106		
Insignia Sports Tourer	80	VOLVO			
Vivaro	81	S60	107		
		S60 Cross Country	108		





AUDI A3	YEAR	TRANSM.	F/R	L/R	BODY STYLE & DRIVE TYPE & ENGINE	REMARKS	GSP Ref.	PRODUCT	ABS	Technical Specifications				
										A	B	C	H	L
1.2 (77 kw)	2010.01-2012.08	AT	F	L	Hatchback FWD CBZB		2612010L	Drive Shaft		36		59.5	40	536
	2010.01-2012.08	AT	F	R	Hatchback FWD CBZB		2610960L	Drive Shaft		36		59.5	40	800
	2013.02-2015.05	5MT/6MT	F	L	Hatchback FWD CJZA		2033730L	Drive Shaft		36		59.5	40	517
	2013.02-2015.05	5MT/6MT	F	R	Hatchback FWD CJZA		2613070L	Drive Shaft		36		59.5	40	820
	2013.02-2015.05	7DCT	F	L	Hatchback FWD CJZA		2612820L	Drive Shaft		36		59.5	40	523
	2013.02-2015.05	7DCT	F	R	Hatchback FWD CJZA		2610960L	Drive Shaft		36		59.5	40	800
	2013.02-2015.05	MT	F	L	Hatchback FWD CJZA		2032940L	Drive Shaft		36		59.5	40	517
	2013.02-2015.05	MT	F	R	Hatchback FWD CJZA		2610420L	Drive Shaft		36		59.5	40	814
	2013.10-2015.05	5MT	F	L	Saloon FWD CJZA		2033730L	Drive Shaft		36		59.5	40	517
	2013.10-2015.05	5MT	F	R	Saloon FWD CJZA		2613070L	Drive Shaft		36		59.5	40	820
	2013.10-2015.05	AT	F	R	Saloon FWD CJZA	Date From:2014.01	2610960L	Drive Shaft		36		59.5	40	800
	2013.10-2015.05	MT	F	L	Saloon FWD CJZA	Date From:2014.01	2032940L	Drive Shaft		36		59.5	40	517
	2013.10-2015.05	MT	F	R	Saloon FWD CJZA	Date From:2014.01	2610420L	Drive Shaft		36		59.5	40	814
1.2 (81 kw)	2014.05-2016.08	6MT	F	L	Hatchback FWD CYVB		2033730L	Drive Shaft		36		59.5	40	517
	2014.05-2016.08	6MT	F	R	Hatchback FWD CYVB		2613070L	Drive Shaft		36		59.5	40	820
	2014.05-2016.08	7DCT	F	L	Hatchback FWD CYVB		2612820L	Drive Shaft		36		59.5	40	523
	2014.05-2016.08	7DCT	F	R	Hatchback FWD CYVB		2610960L	Drive Shaft		36		59.5	40	800
	2014.05-2016.08	MT	F	L	Hatchback FWD CYVB		2032940L	Drive Shaft		36		59.5	40	517
	2014.05-2016.08	6MT	F	L	Saloon FWD CYVB		2033730L	Drive Shaft		36		59.5	40	517
	2014.05-2016.08	6MT	F	R	Saloon FWD CYVB		2613070L	Drive Shaft		36		59.5	40	820
	2014.05-2016.08	MT	F	L	Saloon FWD CYVB		2032940L	Drive Shaft		36		59.5	40	517
1.4 (90 kw)	2012.04-2014.05	6MT	F	L	Hatchback FWD CMBA/CXSA	For PR code:0EJ,Trans. code:MQ250	2612820L	Drive Shaft		36		59.5	40	523
	2012.04-2014.05	6MT	F	R	Hatchback FWD CMBA/CXSA	For PR code:0EJ,Trans. code:MQ250	2612830L	Drive Shaft		36		59.5	40	815
	2012.04-2014.05	6MT	F	R	Hatchback FWD CMBA/CXSA	For PR code:0EC,Trans. code:MQ200_GA	2613070L	Drive Shaft		36		59.5	40	820
	2012.04-2014.05	7DCT	F	R	Hatchback FWD CMBA/CXSA		2610960L	Drive Shaft		36		59.5	40	800
	2013.09-2016.08	6MT	F	L	Saloon FWD CXSA	For PR code:0EJ,Trans. code:MQ250	2612820L	Drive Shaft		36		59.5	40	523
	2013.09-2016.08	6MT	F	R	Saloon FWD CXSA	For PR code:0EJ,Trans. code:MQ250	2612830L	Drive Shaft		36		59.5	40	815
	2013.09-2016.08	6MT	F	R	Saloon FWD CXSA	For PR code:0EC,Trans. code:MQ200_GA	2613070L	Drive Shaft		36		59.5	40	820
	2013.09-2016.08	7DCT	F	L	Saloon FWD CXSA		2612820L	Drive Shaft		36		59.5	40	523
	2013.09-2016.08	7DCT	F	R	Saloon FWD CXSA		2610960L	Drive Shaft		36		59.5	40	800
1.4 (92 kw)	2007.09-2012.08	AT	F	L	Hatchback FWD CAXC/CMSA	Date From:2011.06	2612010L	Drive Shaft		36		59.5	40	536
	2007.09-2012.08	AT	F	L	Hatchback FWD CAXC/CMSA	Date From:2008.12;Date To:2011.05	2612810L	Drive Shaft		36		59.5	40.5	525
	2007.09-2012.08	AT	F	R	Hatchback FWD CAXC/CMSA	Date From:2008.12;Date To:2011.05	2016530L	Drive Shaft		36		59.5	40.5	785
	2007.09-2012.08	AT	F	R	Hatchback FWD CAXC/CMSA	Date From:2011.06	2610960L	Drive Shaft		36		59.5	40	800
	2007.09-2012.08	MT	F	L	Hatchback FWD CAXC/CMSA		2612010L	Drive Shaft		36		59.5	40	536
	2013.09-2016.08	6MT	F	L	Saloon FWD CXSB/CZCA	For PR code:0EJ,Trans. code:MQ250	2612820L	Drive Shaft		36		59.5	40	523
	2013.09-2016.08	6MT	F	R	Saloon FWD CXSB/CZCA	For PR code:0EJ,Trans. code:MQ250	2612830L	Drive Shaft		36		59.5	40	815
	2013.09-2016.08	6MT	F	R	Saloon FWD CXSB/CZCA	For PR code:0EC,Trans. code:MQ200_GA	2613070L	Drive Shaft		36		59.5	40	820
	2013.09-2016.08	7DCT	F	R	Saloon FWD CXSB/CZCA		2610960L	Drive Shaft		36		59.5	40	800
	2014.05-2016.08	6MT	F	L	Hatchback FWD CXSB/CZCA	For PR code:0EJ,Trans. code:MQ250	2612820L	Drive Shaft		36		59.5	40	523
	2014.05-2016.08	6MT	F	R	Hatchback FWD CXSB/CZCA	For PR code:0EJ,Trans. code:MQ250	2612830L	Drive Shaft		36		59.5	40	815
	2014.05-2016.08	6MT	F	R	Hatchback FWD CXSB/CZCA	For PR code:0EC,Trans. code:MQ200_GA	2613070L	Drive Shaft		36		59.5	40	820
	2014.05-2016.08	7DCT	F	L	Hatchback FWD CXSB/CZCA		2612820L	Drive Shaft		36		59.5	40	523
	2014.05-2016.08	7DCT	F	R	Hatchback FWD CXSB/CZCA		2610960L	Drive Shaft		36		59.5	40	800
1.4 (103 kw)	2013.03-2016.08	6MT	F	L	Hatchback FWD CPTA		2612820L	Drive Shaft		36		59.5	40	523
	2013.03-2016.08	6MT	F	R	Hatchback FWD CPTA		2612830L	Drive Shaft		36		59.5	40	815
	2013.03-2016.08	7DCT	F	L	Hatchback FWD CPTA		2611000L	Drive Shaft		36		59.5	40.5	514
	2013.03-2016.08	7DCT	F	R	Hatchback FWD CPTA		2033130L	Drive Shaft		36		59.5	40.5	794
	2013.05-2016.08	6MT	F	L	Saloon FWD CPTA		2612820L	Drive Shaft		36		59.5	40	523
	2013.05-2016.08	6MT	F	R	Saloon FWD CPTA		2612830L	Drive Shaft		36		59.5	40	815
	2013.05-2016.08	7DCT	F	L	Saloon FWD CPTA		2611000L	Drive Shaft		36		59.5	40.5	514
	2013.05-2016.08	7DCT	F	R	Saloon FWD CPTA		2033130L	Drive Shaft		36		59.5	40.5	794
1.4 (110 kw)	2014.05-2017.12	6MT	F	L	Hatchback FWD CZEA		2612820L	Drive Shaft		36		59.5	40	523
	2014.05-2017.12	6MT	F	R	Hatchback FWD CZEA		2612830L	Drive Shaft		36		59.5	40	815
	2014.05-2017.12	7DCT	F	L	Hatchback FWD CZEA		2611000L	Drive Shaft		36		59.5	40.5	514
	2014.05-2017.12	7DCT	F	R	Hatchback FWD CZEA		2033130L	Drive Shaft		36		59.5	40.5	794
	2014.05-2020.10	6MT	F	L	Saloon FWD CZEA		2612820L	Drive Shaft		36		59.5	40	523
	2014.05-2020.10	6MT	F	R	Saloon FWD CZEA		2612830L	Drive Shaft		36		59.5	40	815
	2014.05-2020.10	7DCT	F	L	Saloon FWD CZEA		2611000L	Drive Shaft		36		59.5	40.5	514
	2014.05-2020.10	7DCT	F	R	Saloon FWD CZEA		2033130L	Drive Shaft		36		59.5	40.5	794
1.5 (110 kw)	2017.05-2017.12	6MT	F	L	Hatchback FWD DADA		2612820L	Drive Shaft		36		59.5	40	523
	2017.05-2017.12	7DCT	F	L	Hatchback FWD DADA		2611000L	Drive Shaft		36		59.5	40.5	514
	2017.05-2020.10	6MT	F	L	Saloon FWD DADA/DPCA		2612820L	Drive Shaft		36		59.5	40	523
	2017.05-2020.10	7DCT	F	L	Saloon FWD DADA/DPCA		2611000L	Drive Shaft		36		59.5	40.5	514
	2020.04-	7AT	F	L	Saloon FWD DFYA		2611000L	Drive Shaft		36		59.5	40.5	514



	 YEAR	TRANSM.	F/R	L/R	BODY STYLE & DRIVE TYPE & ENGINE	REMARKS	GSP Ref.	 PRODUCT	 ABS	Technical Specifications										
										A	B	C	H	L						
AUDI A3																				
1.6 (66 kw)	2009.05-2012.08	5MT	F	L	Hatchback FWD CAYB		2032940L	Drive Shaft		36		59.5	40	517						
	2009.05-2012.08	5MT	F	R	Hatchback FWD CAYB		2610420L	Drive Shaft		36		59.5	40	814						
	2009.05-2012.08	5MT	F	R	Hatchback FWD CAYB	Date from:2011.06,For PR code:GOU	2612830L	Drive Shaft		36		59.5	40	815						
1.6 (75 kw)	2003.06-2012.08	7AT	F	L	Hatchback FWD BGU/BSE/BSF/CCSA		2032940L	Drive Shaft		36		59.5	40	517						
	2003.06-2012.08	7AT	F	R	Hatchback FWD BGU/BSE/BSF/CCSA		2610420L	Drive Shaft		36		59.5	40	814						
	2003.06-2012.08	AT	F	R	Hatchback FWD BGU/BSE/BSF/CCSA		2610940L	Drive Shaft		36	26	59.5	40	884						
	2003.06-2012.08	MT	F	R	Hatchback FWD BGU/BSE/BSF/CCSA		2610960L	Drive Shaft		36		59.5	40	800						
	2008.07-2012.08	5MT	F	R	Hatchback FWD CCSA/CMXA		2610960L	Drive Shaft		36		59.5	40	800						
1.6 (77 kw)	2009.05-2012.08	5MT	F	L	Hatchback FWD CAYC	Date to:2011.05,Date from:2011.06,For PR code:GOC	2032940L	Drive Shaft		36		59.5	40	517						
	2009.05-2012.08	5MT	F	R	Hatchback FWD CAYC	Date to:2011.05,Date from:2011.06,For PR code:GOC	2610420L	Drive Shaft		36		59.5	40	814						
	2009.05-2012.08	5MT	F	R	Hatchback FWD CAYC	Date from:2011.06,For PR code:GOU	2612830L	Drive Shaft		36		59.5	40	815						
	2009.05-2012.08	5MT/7DCT	F	L	Hatchback FWD CAYC	Date from:2011.06,For PR code:GOU	2612820L	Drive Shaft		36		59.5	40	523						
	2009.05-2012.08	7DCT	F	L	Hatchback FWD CAYC	Date to:2011.05	2611000L	Drive Shaft		36		59.5	40.5	514						
	2009.05-2012.08	7DCT	F	R	Hatchback FWD CAYC	Date to:2011.05	2033130L	Drive Shaft		36		59.5	40.5	794						
	2009.05-2012.08	7DCT	F	R	Hatchback FWD CAYC	Date from:2011.06	2610960L	Drive Shaft		36		59.5	40	800						
	2012.10-2015.05	6MT	F	R	Hatchback FWD CLHA		2612830L	Drive Shaft		36		59.5	40	815						
	2012.10-2015.05	6MT/7DCT	F	L	Hatchback FWD CLHA		2612820L	Drive Shaft		36		59.5	40	523						
	2012.10-2015.05	7DCT	F	R	Hatchback FWD CLHA		2610960L	Drive Shaft		36		59.5	40	800						
	2013.09-2015.05	6MT	F	R	Saloon FWD CLHA		2612830L	Drive Shaft		36		59.5	40	815						
	2013.09-2015.05	6MT/7DCT	F	L	Saloon FWD CLHA		2612820L	Drive Shaft		36		59.5	40	523						
	2013.09-2015.05	7DCT	F	R	Saloon FWD CLHA		2610960L	Drive Shaft		36		59.5	40	800						
1.6 (81 kw)	2013.09-2017.12	6MT	F	R	Hatchback FWD CRKB/CXXB/DBKA		2612830L	Drive Shaft		36		59.5	40	815						
	2013.09-2017.12	6MT/7DCT	F	L	Hatchback FWD CRKB/CXXB/DBKA		2612820L	Drive Shaft		36		59.5	40	523						
	2013.09-2017.12	7DCT	F	R	Hatchback FWD CRKB/CXXB/DBKA		2610960L	Drive Shaft		36		59.5	40	800						
	2014.05-2020.10	6MT	F	R	Saloon FWD CRKB/CXXB/DBKA		2612830L	Drive Shaft		36		59.5	40	815						
	2014.05-2020.10	6MT/7DCT	F	L	Saloon FWD CRKB/CXXB/DBKA		2612820L	Drive Shaft		36		59.5	40	523						
	2014.05-2020.10	7DCT	F	R	Saloon FWD CRKB/CXXB/DBKA		2610960L	Drive Shaft		36		59.5	40	800						
1.6 (85 kw)	2003.06-2007.09	6MT	F	R	Hatchback FWD BAG/BLF/BLP		2612110L	Drive Shaft		36		59.5	40.5	784						
	2017.02-2020.10	6MT	F	R	Hatchback FWD DDYA/DGTE		2612830L	Drive Shaft		36		59.5	40	815						
	2017.02-2020.10	6MT/7DCT	F	L	Hatchback FWD DDYA/DGTE		2612820L	Drive Shaft		36		59.5	40	523						
	2017.02-2020.10	7DCT	F	R	Hatchback FWD DDYA/DGTE		2610960L	Drive Shaft		36		59.5	40	800						
	2017.03-2020.10	6MT	F	R	Saloon FWD DDYA/DGTE		2612830L	Drive Shaft		36		59.5	40	815						
	2017.03-2020.10	6MT/7DCT	F	L	Saloon FWD DDYA/DGTE		2612820L	Drive Shaft		36		59.5	40	523						
	2017.03-2020.10	7DCT	F	R	Saloon FWD DDYA/DGTE		2610960L	Drive Shaft		36		59.5	40	800						
1.8 (118 kw)	2007.01-2012.08	7AT	F	L	Hatchback FWD BYT/BZB/CDA		2033800L	Drive Shaft		36		59.5	40	487						
	2007.01-2012.08	AT	F	L	Hatchback FWD BYT/BZB/CDA		2032950L	Drive Shaft		36		59.5	40.5	486						
	2007.01-2012.08	AT	F	L	Hatchback FWD BYT/BZB/CDA		2612830L	Drive Shaft		36		59.5	40	815						
	2007.01-2012.08	AT	F	R	Hatchback FWD BYT/BZB/CDA		2016530L	Drive Shaft		36		59.5	40.5	785						
	2007.01-2012.08	MT	F	L	Hatchback FWD BYT/BZB/CDA	Trans. code:MQ350	2032950L	Drive Shaft		36		59.5	40.5	486						
	2007.01-2012.08	MT	F	L	Hatchback FWD BYT/BZB/CDA	Date To:2009.11	2611000L	Drive Shaft		36		59.5	40.5	514						
	2007.01-2012.08	MT	F	L	Hatchback FWD BYT/BZB/CDA	Date From:2009.12	2612820L	Drive Shaft		36		59.5	40	523						
	2007.01-2012.08	MT	F	R	Hatchback FWD BYT/BZB/CDA	Trans. code:MQ350	2033130L	Drive Shaft		36		59.5	40.5	794						
	2007.01-2012.08	MT	F	R	Hatchback FWD BYT/BZB/CDA	Date To:2009.11	2613410L	Drive Shaft		36		59.5	40.5	806						
1.8 (132 kw)	2012.04-2016.08	6MT	F	L	Hatchback FWD CJSA		2611000L	Drive Shaft		36		59.5	40.5	514						
	2013.05-2016.08	6MT	F	L	Saloon FWD CJSA/CJSB		2611000L	Drive Shaft		36		59.5	40.5	514						
1.9 (77 kw)	2003.06-2010.05	6DCT	F	R	Hatchback FWD BKC/BLS/BXE	AAR	2033540L	Drive Shaft		36		59.5	40	760						
	2003.06-2010.05	AT	F	L	Hatchback FWD BKC/BLS/BXE	Date From:2008.02,Chassis no. from:8PFB014001	2033810L	Drive Shaft		36		59.5	40	485						
	2003.06-2010.05	AT	F	L	Hatchback FWD BKC/BLS/BXE		2540130L	Drive Shaft		36		59.5	40.5	482						
	2003.06-2010.05	AT	F	R	Hatchback FWD BKC/BLS/BXE		2540110L	Drive Shaft		36		59.5	40.5	760						
	2003.06-2010.05	MT	F	L	Hatchback FWD BKC/BLS/BXE		2032940L	Drive Shaft		36		59.5	40	517						
	2003.06-2010.05	MT	F	R	Hatchback FWD BKC/BLS/BXE		2610420L	Drive Shaft		36		59.5	40	814						
2.0 (81 kw)	2013.01-2016.08	5MT	F	L	Hatchback FWD CRFA		2612820L	Drive Shaft		36		59.5	40	523						
	2013.01-2016.08	5MT	F	R	Hatchback FWD CRFA		2612830L	Drive Shaft		36		59.5	40	815						
	2013.01-2016.08	MT	F	L	Hatchback FWD CRFA		2032940L	Drive Shaft		36		59.5	40	517						
	2013.05-2016.08	5MT	F	L	Saloon FWD CRFA		2612820L	Drive Shaft		36		59.5	40	523						
	2013.05-2016.08	5MT	F	R	Saloon FWD CRFA		2612830L	Drive Shaft		36		59.5	40	815						
	2013.05-2016.08	MT	F	L	Saloon FWD CRFA		2032940L	Drive Shaft		36		59.5	40	517						
2.0 (100 kw)	2003.06-2012.08	AT	F	L	Hatchback FWD AZV/CBAA/CFFA		2540130L	Drive Shaft		36		59.5	40.5	482						
	2003.06-2012.08	AT	F	R	Hatchback FWD AZV/CBAA/CFFA	Date From:2004.10	2540110L	Drive Shaft		36		59.5	40.5	760						
	2003.06-2012.08	MT	F	R	Hatchback FWD AZV/CBAA/CFFA	Date From:2004.10,For Engine Code:AZV,Chassis no. from:8PFA02201	2033130L	Drive Shaft		36		59.5	40.5	794						
	2003.06-2012.08	MT	F	L/R	Hatchback FWD AZV/CBAA/CFFA	Date To:2004.09,For Engine Code:AZV	2032950L	Drive Shaft		36		59.5	40.5	486						
	2013.05-2016.08	6DCT	F	L	Hatchback FWD CRBD/CRCL		2612850L	Drive Shaft		36		59.5	40	472						
	2013.05-2016.08	6DCT	F	R	Hatchback FWD CRBD/CRCL		2033540L	Drive Shaft		36		59.5	40	760						
	2013.05-2016.08	6MT	F	R	Hatchback FWD CRBD/CRCL		2033130L	Drive Shaft		36		59.5	40.5	794						
	2013.05-2016.08	6DCT	F	L	Saloon FWD CRBD/CRCL		2612850L	Drive Shaft		36		59.5	40	472						



  YEAR	TRANSM.	F/R	L/R	BODY STYLE & DRIVE TYPE & ENGINE	REMARKS	GSP Ref.	 PRODUCT	 ABS	Technical Specifications				
									A	B	C	H	L
AUDI													
A3													
2.0 (100 kw)	2013.05-2016.08	6DCT	F	R	Saloon FWD CRBD/CRLC		2033540L	Drive Shaft	36	59.5	40	760	
	2013.05-2016.08	6MT	F	R	Saloon FWD CRBD/CRLC		2033130L	Drive Shaft	36	59.5	40.5	794	
2.0 (103 kw)	2003.06-2012.08	6DCT	F	L	Hatchback FWD BKD/CBAB/CFPB/CLJA	Chassis no. from SP_5A112101SP_8B01401 For driving school cars	2033810L	Drive Shaft	36	59.5	40	485	
	2003.06-2012.08	6DCT	F	L	Hatchback FWD BKD/CBAB/CFPB/CLJA	Not For driving school cars	2540130L	Drive Shaft	36	59.5	40.5	482	
	2003.06-2012.08	6DCT	F	R	Hatchback FWD BKD/CBAB/CFPB/CLJA	For driving school cars	2033540L	Drive Shaft	36	59.5	40	760	
	2003.06-2012.08	6DCT	F	R	Hatchback FWD BKD/CBAB/CFPB/CLJA	Not For driving school cars	2540110L	Drive Shaft	36	59.5	40.5	760	
	2003.06-2012.08	6MT	F	L	Hatchback FWD BKD/CBAB/CFPB/CLJA	For driving school cars	2032950L	Drive Shaft	36	59.5	40.5	486	
	2003.06-2012.08	6MT	F	R	Hatchback FWD BKD/CBAB/CFPB/CLJA		2033130L	Drive Shaft	36	59.5	40.5	794	
	2003.06-2012.08	6MT	F	L/R	Hatchback FWD BKD/CBAB/CFPB/CLJA	Chassis no. to 8P_5A072500/8P_5B001000	2032950L	Drive Shaft	36	59.5	40.5	486	
	2005.02-2008.06	6DCT	F	L	Hatchback FWD BMM	Chassis no. from SP_5A112101SP_8B01401 For driving school cars	2033810L	Drive Shaft	36	59.5	40	485	
	2005.02-2008.06	6DCT	F	L	Hatchback FWD BMM	Not For driving school cars	2540130L	Drive Shaft	36	59.5	40.5	482	
	2005.02-2008.06	6DCT	F	R	Hatchback FWD BMM	For driving school cars	2033540L	Drive Shaft	36	59.5	40	760	
	2005.02-2008.06	6DCT	F	R	Hatchback FWD BMM	Not For driving school cars	2540110L	Drive Shaft	36	59.5	40.5	760	
	2005.02-2008.06	6MT	F	L	Hatchback FWD BMM		2032950L	Drive Shaft	36	59.5	40.5	486	
2005.02-2008.06	6MT	F	R	Hatchback FWD BMM	Not For driving school cars	2033130L	Drive Shaft	36	59.5	40.5	794		
2.0 (105 kw)	2012.09-2016.08	6AT	F	L	Hatchback FWD CRFC		2612850L	Drive Shaft	36	59.5	40	472	
	2012.09-2016.08	6AT	F	R	Hatchback FWD CRFC		2033540L	Drive Shaft	36	59.5	40	760	
	2013.05-2016.08	6AT	F	L	Saloon FWD CRFC		2612850L	Drive Shaft	36	59.5	40	472	
	2013.05-2016.08	6AT	F	R	Saloon FWD CRFC		2033540L	Drive Shaft	36	59.5	40	760	
2.0 (110 kw)	2003.06-2008.06	AT	F	R	Hatchback FWD AXW/BLR/BLX/BLY/BMB/BVY/BVZ		2610940L	Drive Shaft	36	26	59.5	40	884
	2003.06-2008.06	MT	F	L	Hatchback FWD AXW/BLR/BLX/BLY/BMB/BVY/BVZ		2032940L	Drive Shaft	36	59.5	40	517	
	2003.06-2008.06	MT	F	R	Hatchback FWD AXW/BLR/BLX/BLY/BMB/BVY/BVZ		2610420L	Drive Shaft	36	59.5	40	814	
	2012.04-2017.12	6DCT	F	L	Hatchback FWD CRBC/CRLB/CRUA/DBGA/DCYA/DEJA		2612850L	Drive Shaft	36	59.5	40	472	
	2012.04-2017.12	6DCT	F	R	Hatchback FWD CRBC/CRLB/CRUA/DBGA/DCYA/DEJA		2033540L	Drive Shaft	36	59.5	40	760	
	2012.04-2017.12	6MT	F	R	Hatchback FWD CRBC/CRLB/CRUA/DBGA/DCYA/DEJA		2033130L	Drive Shaft	36	59.5	40.5	794	
	2012.04-2017.12	7DCT	F	L	Hatchback FWD CRBC/CRLB/CRUA/DBGA/DCYA/DEJA		2012650L	Drive Shaft	36	37	59.5	40	558
	2013.05-2020.10	6DCT	F	L	Saloon FWD CRBC/CRLB/CRUA/DBGA/DCYA/DEJA/DFGA		2612850L	Drive Shaft	36	59.5	40	472	
	2013.05-2020.10	6DCT	F	R	Saloon FWD CRBC/CRLB/CRUA/DBGA/DCYA/DEJA/DFGA		2033540L	Drive Shaft	36	59.5	40	760	
2013.05-2020.10	6MT	F	R	Saloon FWD CRBC/CRLB/CRUA/DBGA/DCYA/DEJA/DFGA		2033130L	Drive Shaft	36	59.5	40.5	794		
2013.05-2020.10	7DCT	F	L	Saloon FWD CRBC/CRLB/CRUA/DBGA/DCYA/DEJA/DFGA		2012650L	Drive Shaft	36	37	59.5	40	558	
2.0 (120 kw)	2006.06-2008.06	AT	F	L	Hatchback FWD BUY		2540130L	Drive Shaft	36	59.5	40.5	482	
	2006.06-2008.06	AT	F	R	Hatchback FWD BUY		2540110L	Drive Shaft	36	59.5	40.5	760	
	2006.06-2008.06	MT	F	L	Hatchback FWD BUY		2032950L	Drive Shaft	36	59.5	40.5	486	
	2006.06-2008.06	MT	F	L	Hatchback FWD BUY		2033800L	Drive Shaft	36	59.5	40	487	
2.0 (125 kw)	2006.02-2012.08	AT	F	L	Hatchback FWD BMN/CBBB/CFGB		2033810L	Drive Shaft	36	59.5	40	485	
	2006.02-2012.08	AT	F	L	Hatchback FWD BMN/CBBB/CFGB	For Engine Code:BMN/CBBB/CFGB	2540130L	Drive Shaft	36	59.5	40.5	482	
	2006.02-2012.08	AT	F	R	Hatchback FWD BMN/CBBB/CFGB	For Engine Code:BMN/CBBB/CFGB	2540110L	Drive Shaft	36	59.5	40.5	760	
	2006.02-2012.08	MT	F	L	Hatchback FWD BMN/CBBB/CFGB		2032950L	Drive Shaft	36	59.5	40.5	486	
2.0 (135 kw)	2013.05-2016.08	Semi-AT	F	L	Hatchback FWD CUNA		2612850L	Drive Shaft	36	59.5	40	472	
	2014.05-2020.10	Semi-AT	F	L	Saloon FWD CUNA		2612850L	Drive Shaft	36	59.5	40	472	
2.0 (147 kw)	2004.09-2012.08	AT	F	R	Hatchback FWD AXX/BWA/CAWB/CCZA	Date From:2010.02	2016530L	Drive Shaft	36	59.5	40.5	785	
	2004.09-2012.08	AT/MT	F	L	Hatchback FWD AXX/BWA/CAWB/CCZA	Date To:2010.01	2032950L	Drive Shaft	36	59.5	40.5	486	
A3 Cabrio													
1.2 (77 kw)	2010.03-2013.05	6MT	F	R	Cabriolet FWD CBZB		2610960L	Drive Shaft	36	59.5	40	800	
	2010.03-2013.05	Semi-AT	F	L	Cabriolet FWD CBZB		2612010L	Drive Shaft	36	59.5	40	536	
1.4 (85 kw)	2016.02-2020.10	6MT	F	L	Cabriolet FWD CZCC	For PR code:0EJ,Trans. code:MQ250	2612820L	Drive Shaft	36	59.5	40	523	
	2016.02-2020.10	6MT	F	R	Cabriolet FWD CZCC	For PR code:0EJ,Trans. code:MQ250	2612830L	Drive Shaft	36	59.5	40	815	
	2016.02-2020.10	6MT	F	R	Cabriolet FWD CZCC	For PR code:0EC,Trans. code:MQ200_GA	2613070L	Drive Shaft	36	59.5	40	820	
	2016.02-2020.10	7DCT	F	L	Cabriolet FWD CZCC		2612820L	Drive Shaft	36	59.5	40	523	
	2016.02-2020.10	7DCT	F	R	Cabriolet FWD CZCC		2610960L	Drive Shaft	36	59.5	40	800	
1.4 (92 kw)	2011.02-2013.05	6MT	F	L	Cabriolet FWD CAXC		2612010L	Drive Shaft	36	59.5	40	536	
	2011.02-2013.05	6MT	F	R	Cabriolet FWD CAXC		2610960L	Drive Shaft	36	59.5	40	800	
	2014.02-2016.07	6MT	F	L	Cabriolet FWD CXSB/CZCA	For PR code:0EJ,Trans. code:MQ250	2612820L	Drive Shaft	36	59.5	40	523	
	2014.02-2016.07	6MT	F	R	Cabriolet FWD CXSB/CZCA	For PR code:0EJ,Trans. code:MQ250	2612830L	Drive Shaft	36	59.5	40	815	
	2014.02-2016.07	6MT	F	R	Cabriolet FWD CXSB/CZCA	For PR code:0EC,Trans. code:MQ200_GA	2613070L	Drive Shaft	36	59.5	40	820	
	2014.02-2016.07	7DCT	F	L	Cabriolet FWD CXSB/CZCA		2612820L	Drive Shaft	36	59.5	40	523	
	2014.02-2016.07	7DCT	F	R	Cabriolet FWD CXSB/CZCA		2610960L	Drive Shaft	36	59.5	40	800	
	2014.02-2016.07	MT	F	L	Cabriolet FWD CXSB/CZCA		2032940L	Drive Shaft	36	59.5	40	517	
1.4 (103 kw)	2013.10-2014.05	6MT	F	L	Cabriolet FWD CPTA		2612820L	Drive Shaft	36	59.5	40	523	
	2013.10-2014.05	6MT	F	R	Cabriolet FWD CPTA		2612830L	Drive Shaft	36	59.5	40	815	
	2013.10-2014.05	7DCT	F	L	Cabriolet FWD CPTA		2611000L	Drive Shaft	36	59.5	40.5	514	
	2013.10-2014.05	7DCT	F	R	Cabriolet FWD CPTA		2033130L	Drive Shaft	36	59.5	40.5	794	
1.4 (110 kw)	2014.05-2020.10	6MT	F	L	Cabriolet FWD CZEA		2612820L	Drive Shaft	36	59.5	40	523	
	2014.05-2020.10	6MT	F	R	Cabriolet FWD CZEA		2612830L	Drive Shaft	36	59.5	40	815	
	2014.05-2020.10	7DCT	F	L	Cabriolet FWD CZEA		2611000L	Drive Shaft	36	59.5	40.5	514	





		TRANSM.	F/R	L/R	BODY STYLE & DRIVE TYPE & ENGINE	REMARKS	GSP Ref.		ABS	Technical Specifications				
										A	B	C	H	L
AUDI														
A3 Cabrio														
1.4 (110 kw)	2014.05-2020.10	7DCT	F	R	Cabriolet FWD CZEA		2033130L	Drive Shaft		36	59.5	40.5	794	
1.5 (110 kw)	2017.05-2020.10	6MT	F	L	Cabriolet FWD DADA/DPCA		2612820L	Drive Shaft		36	59.5	40	523	
	2017.05-2020.10	7DCT	F	L	Cabriolet FWD DADA/DPCA		2611000L	Drive Shaft		36	59.5	40.5	514	
1.6 (75 kw)	2008.09-2010.05	5MT	F	R	Cabriolet FWD BSE		2610960L	Drive Shaft		36	59.5	40	800	
1.6 (77 kw)	2009.05-2013.05	5MT	F	L	Cabriolet FWD CAYC		2032940L	Drive Shaft		36	59.5	40	517	
	2009.05-2013.05	5MT	F	R	Cabriolet FWD CAYC		2610420L	Drive Shaft		36	59.5	40	814	
1.6 (81 kw)	2014.02-2020.10	6MT	F	L	Cabriolet FWD CRKB/CXXB		2612820L	Drive Shaft		36	59.5	40	523	
	2014.02-2020.10	6MT	F	R	Cabriolet FWD CRKB/CXXB		2612830L	Drive Shaft		36	59.5	40	815	
	2014.02-2020.10	MT	F	L	Cabriolet FWD CRKB/CXXB		2032940L	Drive Shaft		36	59.5	40	517	
1.6 (85 kw)	2017.04-2020.10	6MT	F	L	Cabriolet FWD DDYA		2612820L	Drive Shaft		36	59.5	40	523	
	2017.04-2020.10	6MT	F	R	Cabriolet FWD DDYA		2612830L	Drive Shaft		36	59.5	40	815	
1.8 (118 kw)	2008.04-2013.05	6AT	F	L	Cabriolet FWD BZB/CDA		2032950L	Drive Shaft		36	59.5	40.5	486	
	2008.04-2013.05	6AT	F	L	Cabriolet FWD BZB/CDA	For Engine Code:BZB	2612830L	Drive Shaft		36	59.5	40	815	
	2008.04-2013.05	6AT	F	R	Cabriolet FWD BZB/CDA		2016530L	Drive Shaft		36	59.5	40.5	785	
	2008.04-2013.05	7AT	F	L	Cabriolet FWD BZB/CDA		2033800L	Drive Shaft		36	59.5	40	487	
	2008.04-2013.05	7AT	F	R	Cabriolet FWD BZB/CDA		2611470L	Drive Shaft		36	59.5	40.5	795	
	2008.04-2013.05	7DCT	F	R	Cabriolet FWD BZB/CDA		2033130L	Drive Shaft		36	59.5	40.5	794	
	2008.04-2013.05	MT	F	L	Cabriolet FWD BZB/CDA	Date To:2009.11,For Engine Code:BZB/CDA	2611000L	Drive Shaft		36	59.5	40.5	514	
	2008.04-2013.05	MT	F	L	Cabriolet FWD BZB/CDA	Date From:2009.12	2612820L	Drive Shaft		36	59.5	40	523	
2008.04-2013.05	MT	F	R	Cabriolet FWD BZB/CDA	Date To:2009.11,For Engine Code:BZB/CDA	2613410L	Drive Shaft		36	59.5	40.5	806		
1.8 (132 kw)	2013.10-2016.07	6MT	F	L	Cabriolet FWD CJSB/CJSB		2611000L	Drive Shaft		36	59.5	40.5	514	
1.9 (77 kw)	2008.04-2009.10	5MT	F	L	Cabriolet FWD BLS		2032940L	Drive Shaft		36	59.5	40	517	
	2008.04-2009.10	5MT	F	R	Cabriolet FWD BLS		2610420L	Drive Shaft		36	59.5	40	814	
2.0 (100 kw)	2008.04-2013.05	AT	F	L	Cabriolet FWD CBAA/CFFA		2033810L	Drive Shaft		36	59.5	40	485	
	2008.04-2013.05	AT	F	L	Cabriolet FWD CBAA/CFFA		2540130L	Drive Shaft		36	59.5	40.5	482	
	2008.04-2013.05	AT	F	R	Cabriolet FWD CBAA/CFFA		2540110L	Drive Shaft		36	59.5	40.5	760	
	2008.04-2013.05	MT	F	L	Cabriolet FWD CBAA/CFFA	Rims:With alloy rim	2032950L	Drive Shaft		36	59.5	40.5	486	
	2008.04-2013.05	MT	F	L	Cabriolet FWD CBAA/CFFA	Rims:With steel rim	2033800L	Drive Shaft		36	59.5	40	487	
	2008.04-2013.05	MT	F	R	Cabriolet FWD CBAA/CFFA		2033130L	Drive Shaft		36	59.5	40.5	794	
	2008.04-2013.05	MT	F	R	Cabriolet FWD CBAA/CFFA		2033800L	Drive Shaft		36	59.5	40	487	
	2014.05-2016.07	6DCT	F	L	Cabriolet FWD CRLC		2612850L	Drive Shaft		36	59.5	40	472	
	2014.05-2016.07	6DCT	F	R	Cabriolet FWD CRLC		2033540L	Drive Shaft		36	59.5	40	760	
	2014.05-2016.07	6MT	F	R	Cabriolet FWD CRLC		2033130L	Drive Shaft		36	59.5	40.5	794	
2.0 (103 kw)	2008.04-2013.05	AT	F	L	Cabriolet FWD CBAB/CFFB		2033810L	Drive Shaft		36	59.5	40	485	
	2008.04-2013.05	AT	F	L	Cabriolet FWD CBAB/CFFB		2540130L	Drive Shaft		36	59.5	40.5	482	
	2008.04-2013.05	AT	F	R	Cabriolet FWD CBAB/CFFB		2540110L	Drive Shaft		36	59.5	40.5	760	
	2008.04-2013.05	MT	F	L	Cabriolet FWD CBAB/CFFB	Rims:With alloy rim	2032950L	Drive Shaft		36	59.5	40.5	486	
	2008.04-2013.05	MT	F	L	Cabriolet FWD CBAB/CFFB	Rims:With steel rim	2033800L	Drive Shaft		36	59.5	40	487	
	2008.04-2013.05	MT	F	R	Cabriolet FWD CBAB/CFFB		2033130L	Drive Shaft		36	59.5	40.5	794	
	2008.04-2013.05	MT	F	R	Cabriolet FWD CBAB/CFFB		2033800L	Drive Shaft		36	59.5	40	487	
2.0 (110 kw)	2013.10-2020.10	6DCT	F	L	Cabriolet FWD CRLB/DCYA		2612850L	Drive Shaft		36	59.5	40	472	
	2013.10-2020.10	6DCT	F	R	Cabriolet FWD CRLB/DCYA		2033540L	Drive Shaft		36	59.5	40	760	
	2013.10-2020.10	6MT	F	R	Cabriolet FWD CRLB/DCYA		2033130L	Drive Shaft		36	59.5	40.5	794	
2.0 (135 kw)	2014.05-2016.07	Semi-AT	F	L	Cabriolet FWD CUNA		2612850L	Drive Shaft		36	59.5	40	472	
2.0 (147 kw)	2008.04-2013.05	AT	F	R	Cabriolet FWD CAWB/CCZA	Date From:2010.04,For Engine Code:CCZA	2016530L	Drive Shaft		36	59.5	40.5	785	
	2008.04-2013.05	AT/MT	F	L	Cabriolet FWD CAWB/CCZA	Date To:2009.03,For Engine Code:CCZA,For Engine Code:CAWB	2032950L	Drive Shaft		36	59.5	40.5	486	
	2008.04-2013.05	MT/Semi-AT	F	L	Cabriolet FWD CAWB/CCZA		2033800L	Drive Shaft		36	59.5	40	487	
A3 Cabrio Quattro														
2.0 (135 kw)	2014.05-2020.10	6AT	F	L	Cabriolet 4WD CUNA/DGCA		2612850L	Drive Shaft		36	59.5	40	472	
A3 Quattro														
1.8 (118 kw)	2008.07-2012.08	6MT	F	L	Hatchback 4WD CDA	Rims:With alloy rim	2032950L	Drive Shaft		36	59.5	40.5	486	
	2008.07-2012.08	6MT	F	R	Hatchback 4WD CDA		2032660L	Drive Shaft		36	59.5	40.5	601	
2.0 (100 kw)	2003.06-2008.06	AT	F	R	Hatchback 4WD AZV	Chassis no. from:SP-5A073 501,Chassis no. from:SP-6B011 001	2540110L	Drive Shaft		36	59.5	40.5	760	
	2003.06-2008.06	AT	F	R	Hatchback 4WD AZV		2540130L	Drive Shaft		36	59.5	40.5	482	
	2003.06-2008.06	MT	F	L	Hatchback 4WD AZV		2032950L	Drive Shaft		36	59.5	40.5	486	
	2003.06-2008.06	MT	F	L	Hatchback 4WD AZV		2033800L	Drive Shaft		36	59.5	40	487	
	2003.06-2008.06	MT	F	R	Hatchback 4WD AZV		2032660L	Drive Shaft		36	59.5	40.5	601	
2.0 (103 kw)	2004.08-2012.08	6MT	F	L	Hatchback 4WD BKD/CBAB/CFFB		2032950L	Drive Shaft		36	59.5	40.5	486	
	2004.08-2012.08	6MT	F	R	Hatchback 4WD BKD/CBAB/CFFB	For Engine Code:BKD	2032660L	Drive Shaft		36	59.5	40.5	601	
	2004.08-2012.08	6MT	F	R	Hatchback 4WD BKD/CBAB/CFFB	For Engine Code:CBAB/CFFB	2033800L	Drive Shaft		36	59.5	40	487	
	2004.08-2012.08	MT	F	L	Hatchback 4WD BKD/CBAB/CFFB		2033800L	Drive Shaft		36	59.5	40	487	
	2006.01-2007.05	6MT	F	L	Hatchback 4WD BMM		2032950L	Drive Shaft		36	59.5	40.5	486	
	2006.01-2007.05	6MT	F	R	Hatchback 4WD BMM		2032660L	Drive Shaft		36	59.5	40.5	601	
2006.01-2007.05	MT	F	L	Hatchback 4WD BMM		2033800L	Drive Shaft		36	59.5	40	487		
2.0 (110 kw)	2012.10-2017.12	6MT	F	R	Hatchback 4WD CRBC/CRLB/DCYA		2033130L	Drive Shaft		36	59.5	40.5	794	





	 YEAR	TRANSM.	F/R	L/R	BODY STYLE & DRIVE TYPE & ENGINE	REMARKS	GSP Ref.	 PRODUCT	 ABS	Technical Specifications				
										A	B	C	H	L
AUDI A3 Quattro														
2.0 (110 kw)	2013.10-2020.10	6MT	F	R	Saloon 4WD CRBC/CRLB/DCYA		2033130L	Drive Shaft		36		59.5	40.5	794
2.0 (125 kw)	2006.02-2012.08	6MT	F	L	Hatchback 4WD BMN/CBBB/CFGB		2032950L	Drive Shaft		36		59.5	40.5	486
	2006.02-2012.08	6MT	F	R	Hatchback 4WD BMN/CBBB/CFGB		2032660L	Drive Shaft		36		59.5	40.5	601
	2006.02-2012.08	MT/Semi-AT	F	L	Hatchback 4WD BMN/CBBB/CFGB		2033800L	Drive Shaft		36		59.5	40	487
2.0 (135 kw)	2013.05-2017.12	6DCT	F	L	Hatchback 4WD CUNA/DGCA		2612850L	Drive Shaft		36		59.5	40	472
	2014.05-2019.07	6DCT	F	L	Saloon 4WD CUNA/DGCA/DJGA		2612850L	Drive Shaft		36		59.5	40	472
	2014.05-2019.07	6DCT	F	L	Saloon 4WD CUNA/DGCA/DJGA	For Modelcode:8V1;For PR code:2H7	2612850L	Drive Shaft		36		59.5	40	472
	2014.05-2019.07	7DCT	F	L	Saloon 4WD CUNA/DGCA/DJGA		2012650L	Drive Shaft		36	37	59.5	40	558
2.0 (147 kw)	2004.09-2012.08	6AT/6MT	F	L	Hatchback 4WD AXX/BWA/CCZA		2032950L	Drive Shaft		36		59.5	40.5	486
	2004.09-2012.08	6AT/6MT	F	R	Hatchback 4WD AXX/BWA/CCZA		2032660L	Drive Shaft		36		59.5	40.5	601
	2004.09-2012.08	MT/Semi-AT	F	L	Hatchback 4WD AXX/BWA/CCZA		2033800L	Drive Shaft		36		59.5	40	487
3.2 (184 kw)	2003.07-2009.05	AT	F	L	Hatchback 4WD BDB/BMJ/BUB	For vehicles without direct shift gear box. Check no from 8P1-7-086-001	2032950L	Drive Shaft		36		59.5	40.5	486
	2003.07-2009.05	AT/MT	F	L	Hatchback 4WD BDB/BMJ/BUB		2033800L	Drive Shaft		36		59.5	40	487
	2003.07-2009.05	AT/MT	F	R	Hatchback 4WD BDB/BMJ/BUB		2032660L	Drive Shaft		36		59.5	40.5	601
	2003.07-2009.05	MT	F	L	Hatchback 4WD BDB/BMJ/BUB		2032950L	Drive Shaft		36		59.5	40.5	486
A3 Sportback														
1.2 (77 kw)	2010.01-2013.03	AT	F	L	Hatchback FWD CBZB		2612010L	Drive Shaft		36		59.5	40	536
	2010.01-2013.03	AT	F	R	Hatchback FWD CBZB		2610960L	Drive Shaft		36		59.5	40	800
	2012.09-2015.05	6MT	F	L	Hatchback FWD CJZA		2033730L	Drive Shaft		36		59.5	40	517
	2012.09-2015.05	6MT	F	R	Hatchback FWD CJZA		2613070L	Drive Shaft		36		59.5	40	820
	2012.09-2015.05	7DCT	F	L	Hatchback FWD CJZA		2612820L	Drive Shaft		36		59.5	40	523
	2012.09-2015.05	7DCT	F	R	Hatchback FWD CJZA		2610960L	Drive Shaft		36		59.5	40	800
	2012.09-2015.05	MT	F	L	Hatchback FWD CJZA		2032940L	Drive Shaft		36		59.5	40	517
	2012.09-2015.05	MT	F	R	Hatchback FWD CJZA		2610420L	Drive Shaft		36		59.5	40	814
1.2 (81 kw)	2014.05-2016.08	6MT	F	L	Hatchback FWD CYVB		2033730L	Drive Shaft		36		59.5	40	517
	2014.05-2016.08	6MT	F	R	Hatchback FWD CYVB		2613070L	Drive Shaft		36		59.5	40	820
	2014.05-2016.08	7DCT	F	L	Hatchback FWD CYVB		2612820L	Drive Shaft		36		59.5	40	523
	2014.05-2016.08	7DCT	F	R	Hatchback FWD CYVB		2610960L	Drive Shaft		36		59.5	40	800
1.4 (81 kw)	2013.11-2020.10	6MT	F	L	Hatchback FWD CPWA	For PR code:0EJ;Trans. code:MQ250_GA	2612820L	Drive Shaft		36		59.5	40	523
	2013.11-2020.10	6MT	F	R	Hatchback FWD CPWA	For PR code:0EJ;Trans. code:MQ250	2612830L	Drive Shaft		36		59.5	40	815
	2013.11-2020.10	6MT	F	R	Hatchback FWD CPWA	For PR code:0EC;Trans. code:MQ200_GA	2613070L	Drive Shaft		36		59.5	40	820
	2013.11-2020.10	7DCT	F	L	Hatchback FWD CPWA		2612820L	Drive Shaft		36		59.5	40	523
	2013.11-2020.10	7DCT	F	R	Hatchback FWD CPWA		2610960L	Drive Shaft		36		59.5	40	800
1.4 (90 kw)	2012.09-2016.08	6MT	F	L	Hatchback FWD CMBA/CXSA	For PR code:0EJ;Trans. code:MQ250_GA	2612820L	Drive Shaft		36		59.5	40	523
	2012.09-2016.08	6MT	F	R	Hatchback FWD CMBA/CXSA	For PR code:0EJ;Trans. code:MQ250	2612830L	Drive Shaft		36		59.5	40	815
	2012.09-2016.08	6MT	F	R	Hatchback FWD CMBA/CXSA	For PR code:0EC;Trans. code:MQ200_GA	2613070L	Drive Shaft		36		59.5	40	820
	2012.09-2016.08	7DCT	F	L	Hatchback FWD CMBA/CXSA		2612820L	Drive Shaft		36		59.5	40	523
	2012.09-2016.08	7DCT	F	R	Hatchback FWD CMBA/CXSA		2610960L	Drive Shaft		36		59.5	40	800
1.4 (92 kw)	2007.09-2013.03	AT	F	L	Hatchback FWD CAXC/CMSA	Date From:2011.06	2612010L	Drive Shaft		36		59.5	40	536
	2007.09-2013.03	AT	F	L	Hatchback FWD CAXC/CMSA	Date From:2008.12;Date To:2011.05	2612810L	Drive Shaft		36		59.5	40.5	525
	2007.09-2013.03	AT	F	R	Hatchback FWD CAXC/CMSA	Date From:2008.12;Date To:2011.05	2016530L	Drive Shaft		36		59.5	40.5	785
	2007.09-2013.03	AT	F	R	Hatchback FWD CAXC/CMSA	Date From:2011.06	2610960L	Drive Shaft		36		59.5	40	800
	2007.09-2013.03	MT	F	L	Hatchback FWD CAXC/CMSA	Date From:2011.06	2612010L	Drive Shaft		36		59.5	40	536
	2014.05-2016.08	6MT	F	L	Hatchback FWD CXSB/CZCA	For PR code:0EJ;Trans. code:MQ250_GA	2612820L	Drive Shaft		36		59.5	40	523
	2014.05-2016.08	6MT	F	R	Hatchback FWD CXSB/CZCA	For PR code:0EJ;Trans. code:MQ250	2612830L	Drive Shaft		36		59.5	40	815
	2014.05-2016.08	6MT	F	R	Hatchback FWD CXSB/CZCA	For PR code:0EC;Trans. code:MQ200_GA	2613070L	Drive Shaft		36		59.5	40	820
	2014.05-2016.08	7DCT	F	L	Hatchback FWD CXSB/CZCA		2612820L	Drive Shaft		36		59.5	40	523
	2014.05-2016.08	7DCT	F	R	Hatchback FWD CXSB/CZCA		2610960L	Drive Shaft		36		59.5	40	800
1.4 (103 kw)	2013.03-2014.11	6MT	F	L	Hatchback FWD CPTA		2612820L	Drive Shaft		36		59.5	40	523
	2013.03-2014.11	6MT	F	R	Hatchback FWD CPTA		2612830L	Drive Shaft		36		59.5	40	815
	2013.03-2014.11	7DCT	F	L	Hatchback FWD CPTA		2611000L	Drive Shaft		36		59.5	40.5	514
	2013.03-2014.11	7DCT	F	R	Hatchback FWD CPTA		2033130L	Drive Shaft		36		59.5	40.5	794
1.4 (110 kw)	2014.05-2020.10	6MT	F	L	Hatchback FWD CZEA		2612820L	Drive Shaft		36		59.5	40	523
	2014.05-2020.10	6MT	F	R	Hatchback FWD CZEA		2612830L	Drive Shaft		36		59.5	40	815
	2014.05-2020.10	7DCT	F	L	Hatchback FWD CZEA		2611000L	Drive Shaft		36		59.5	40.5	514
	2014.05-2020.10	7DCT	F	R	Hatchback FWD CZEA		2033130L	Drive Shaft		36		59.5	40.5	794
1.5 (96 kw)	2018.11-2020.10	7AT	F	L	Hatchback FWD DHFA		2612820L	Drive Shaft		36		59.5	40	523
1.5 (110 kw)	2017.05-2020.10	6MT	F	L	Hatchback FWD DADA/DPCA		2612820L	Drive Shaft		36		59.5	40	523
	2017.05-2020.10	7DCT	F	L	Hatchback FWD DADA/DPCA		2611000L	Drive Shaft		36		59.5	40.5	514
	2020.04-	7AT	F	L	Hatchback FWD DFYA		2611000L	Drive Shaft		36		59.5	40.5	514
1.6 (66 kw)	2009.05-2013.03	5MT	F	L	Hatchback FWD CAYB		2032940L	Drive Shaft		36		59.5	40	517
	2009.05-2013.03	5MT	F	R	Hatchback FWD CAYB		2610420L	Drive Shaft		36		59.5	40	814
	2009.05-2013.03	5MT	F	R	Hatchback FWD CAYB	Date from:2011.06;For PR code:GOU	2612830L	Drive Shaft		36		59.5	40	815
1.6 (75 kw)	2004.09-2013.03	7AT	F	L	Hatchback FWD BGU/BSE/BSF/CCSA		2032940L	Drive Shaft		36		59.5	40	517
	2004.09-2013.03	7AT	F	R	Hatchback FWD BGU/BSE/BSF/CCSA		2610420L	Drive Shaft		36		59.5	40	814





  YEAR	TRANSM.	F/R	L/R	BODY STYLE & DRIVE TYPE & ENGINE	REMARKS	GSP Ref.	 PRODUCT	 ABS	Technical Specifications					
									A	B	C	H	L	
AUDI														
A3 Sportback														
1.6 (75 kw)	2004.09-2013.03	AT	F	R	Hatchback FWD BGU/BSE/BSF/CCSA		2610940L	Drive Shaft		36	26	59.5	40	884
	2004.09-2013.03	MT	F	R	Hatchback FWD BGU/BSE/BSF/CCSA		2610960L	Drive Shaft		36		59.5	40	800
	2008.07-2013.03	5MT	F	R	Hatchback FWD CCSA/CMXA		2610960L	Drive Shaft		36		59.5	40	800
1.6 (77 kw)	2009.05-2012.08	5MT	F	L	Hatchback FWD CAYC	Date to:2011.05,Date from:2011.06,For PR code:G0C	2032940L	Drive Shaft		36		59.5	40	517
	2009.05-2012.08	5MT	F	R	Hatchback FWD CAYC	Date to:2011.05,Date from:2011.06,For PR code:G0C	2610420L	Drive Shaft		36		59.5	40	814
	2009.05-2012.08	5MT	F	R	Hatchback FWD CAYC	Date from:2011.06,For PR code:G0U	2612830L	Drive Shaft		36		59.5	40	815
	2009.05-2012.08	5MT/7DCT	F	L	Hatchback FWD CAYC	Vehicle 99 Date from:2011.06,For PR code:G0L,Vehicle 90 Date from:2011.06	2612820L	Drive Shaft		36		59.5	40	523
	2009.05-2012.08	7DCT	F	L	Hatchback FWD CAYC	Date to:2011.05	2611000L	Drive Shaft		36		59.5	40.5	514
	2009.05-2012.08	7DCT	F	R	Hatchback FWD CAYC	Date to:2011.05	2033130L	Drive Shaft		36		59.5	40.5	794
	2009.05-2012.08	7DCT	F	R	Hatchback FWD CAYC	Date from:2011.06	2610960L	Drive Shaft		36		59.5	40	800
	2013.01-2016.12	6MT	F	R	Hatchback FWD CLHA		2612830L	Drive Shaft		36		59.5	40	815
	2013.01-2016.12	6MT/7DCT	F	L	Hatchback FWD CLHA		2612820L	Drive Shaft		36		59.5	40	523
	2013.01-2016.12	7DCT	F	R	Hatchback FWD CLHA		2610960L	Drive Shaft		36		59.5	40	800
1.6 (81 kw)	2013.09-2020.10	6MT	F	R	Hatchback FWD CRKB/CXXB/DBKA		2612830L	Drive Shaft		36		59.5	40	815
	2013.09-2020.10	6MT/7DCT	F	L	Hatchback FWD CRKB/CXXB/DBKA		2612820L	Drive Shaft		36		59.5	40	523
	2013.09-2020.10	7DCT	F	R	Hatchback FWD CRKB/CXXB/DBKA		2610960L	Drive Shaft		36		59.5	40	800
1.6 (85 kw)	2004.09-2007.09	6MT	F	R	Hatchback FWD BLF/BLP		2612110L	Drive Shaft		36		59.5	40.5	784
	2017.02-2020.10	6MT	F	R	Hatchback FWD DDYA/DGTE		2612830L	Drive Shaft		36		59.5	40	815
	2017.02-2020.10	6MT/7DCT	F	L	Hatchback FWD DDYA/DGTE		2612820L	Drive Shaft		36		59.5	40	523
	2017.02-2020.10	7DCT	F	R	Hatchback FWD DDYA/DGTE		2610960L	Drive Shaft		36		59.5	40	800
1.8 (118 kw)	2007.01-2013.03	7AT	F	L	Hatchback FWD BYT/BZB/CDA		2033800L	Drive Shaft		36		59.5	40	487
	2007.01-2013.03	AT	F	R	Hatchback FWD BYT/BZB/CDA		2016530L	Drive Shaft		36		59.5	40.5	785
	2007.01-2013.03	MT	F	L	Hatchback FWD BYT/BZB/CDA	Trans. code:MQ350	2032950L	Drive Shaft		36		59.5	40.5	486
	2007.01-2013.03	MT	F	L	Hatchback FWD BYT/BZB/CDA	Date To:2009.11	2611000L	Drive Shaft		36		59.5	40.5	514
	2007.01-2013.03	MT	F	L	Hatchback FWD BYT/BZB/CDA	Date From:2009.12	2612820L	Drive Shaft		36		59.5	40	523
	2007.01-2013.03	MT	F	L	Hatchback FWD BYT/BZB/CDA	Trans. code:MQ350	2612830L	Drive Shaft		36		59.5	40	815
	2007.01-2013.03	MT	F	R	Hatchback FWD BYT/BZB/CDA	Trans. code:MQ350	2033130L	Drive Shaft		36		59.5	40.5	794
	2007.01-2013.03	MT	F	R	Hatchback FWD BYT/BZB/CDA	Date To:2009.11	2613410L	Drive Shaft		36		59.5	40.5	806
1.8 (132 kw)	2012.03-2016.08	6MT	F	L	Hatchback FWD CJS/A/CJSB		2611000L	Drive Shaft		36		59.5	40.5	514
1.9 (77 kw)	2004.09-2010.05	6DCT	F	R	Hatchback FWD BKC/BLS/BXE	AAR	2033540L	Drive Shaft		36		59.5	40	760
	2004.09-2010.05	AT	F	L	Hatchback FWD BKC/BLS/BXE	Date From:2007.12,Chassis no. from:8FA112001,For driving school cars	2033810L	Drive Shaft		36		59.5	40	485
	2004.09-2010.05	AT	F	L	Hatchback FWD BKC/BLS/BXE	Date To:2008.06,Chassis no. to:8P8B050000	2540130L	Drive Shaft		36		59.5	40.5	482
	2004.09-2010.05	AT	F	R	Hatchback FWD BKC/BLS/BXE		2540110L	Drive Shaft		36		59.5	40.5	760
	2004.09-2010.05	MT	F	L	Hatchback FWD BKC/BLS/BXE		2032940L	Drive Shaft		36		59.5	40	517
	2004.09-2010.05	MT	F	R	Hatchback FWD BKC/BLS/BXE		2610420L	Drive Shaft		36		59.5	40	814
2.0 (81 kw)	2013.05-2016.08	5MT	F	L	Hatchback FWD CRFA		2612820L	Drive Shaft		36		59.5	40	523
	2013.05-2016.08	5MT	F	R	Hatchback FWD CRFA		2612830L	Drive Shaft		36		59.5	40	815
	2013.05-2016.08	MT	F	L	Hatchback FWD CRFA		2032940L	Drive Shaft		36		59.5	40	517
2.0 (85 kw)	2019.11-	7DCT	F	L	Hatchback FWD DSUD/DTRB/DTRD		2612820L	Drive Shaft		36		59.5	40	523
2.0 (100 kw)	2004.09-2013.03	AT	F	L	Hatchback FWD AZV/CBAA/CFFA		2540130L	Drive Shaft		36		59.5	40.5	482
	2004.09-2013.03	AT	F	R	Hatchback FWD AZV/CBAA/CFFA		2540110L	Drive Shaft		36		59.5	40.5	760
	2004.09-2013.03	MT	F	L	Hatchback FWD AZV/CBAA/CFFA	For Engine Code:CBAB/CFFB,With alloy rim	2032950L	Drive Shaft		36		59.5	40.5	486
	2004.09-2013.03	MT	F	L	Hatchback FWD AZV/CBAA/CFFA	For Engine Code:AZV,For driving school cars	2032950L	Drive Shaft		36		59.5	40.5	486
	2004.09-2013.03	MT	F	L	Hatchback FWD AZV/CBAA/CFFA	For Engine Code:CBAB/CFFB,With steel rim	2033800L	Drive Shaft		36		59.5	40	487
	2004.09-2013.03	MT	F	R	Hatchback FWD AZV/CBAA/CFFA	For Engine Code:AZV,For driving school cars	2033130L	Drive Shaft		36		59.5	40.5	794
	2004.09-2013.03	MT	F	R	Hatchback FWD AZV/CBAA/CFFA		2033800L	Drive Shaft		36		59.5	40	487
	2004.09-2013.03	MT	F	L/R	Hatchback FWD AZV/CBAA/CFFA	For Engine Code:AZV	2032950L	Drive Shaft		36		59.5	40.5	486
	2013.05-2016.08	6DCT	F	L	Hatchback FWD CRBD/CRLC		2612850L	Drive Shaft		36		59.5	40	472
	2013.05-2016.08	6DCT	F	R	Hatchback FWD CRBD/CRLC		2033540L	Drive Shaft		36		59.5	40	760
	2013.05-2016.08	6MT	F	R	Hatchback FWD CRBD/CRLC		2033130L	Drive Shaft		36		59.5	40.5	794
2.0 (103 kw)	2004.09-2013.03	6DCT	F	L	Hatchback FWD BKD/CBAB/CFFB/CLJA	Chassis no from:8P_5A1121018P_8B014001,For driving school cars	2033810L	Drive Shaft		36		59.5	40	485
	2004.09-2013.03	6DCT	F	L	Hatchback FWD BKD/CBAB/CFFB/CLJA	Not For driving school cars	2540130L	Drive Shaft		36		59.5	40.5	482
	2004.09-2013.03	6DCT	F	R	Hatchback FWD BKD/CBAB/CFFB/CLJA	For driving school cars	2033540L	Drive Shaft		36		59.5	40	760
	2004.09-2013.03	6DCT	F	R	Hatchback FWD BKD/CBAB/CFFB/CLJA	Not For driving school cars	2540110L	Drive Shaft		36		59.5	40.5	760
	2004.09-2013.03	6MT	F	L	Hatchback FWD BKD/CBAB/CFFB/CLJA	For driving school cars	2032950L	Drive Shaft		36		59.5	40.5	486
	2004.09-2013.03	6MT	F	L	Hatchback FWD BKD/CBAB/CFFB/CLJA	Date from:2007.12,Chassis no. from:8P_5A0725008P_5B001000	2033800L	Drive Shaft		36		59.5	40	487
	2004.09-2013.03	6MT	F	R	Hatchback FWD BKD/CBAB/CFFB/CLJA		2033130L	Drive Shaft		36		59.5	40.5	794
	2004.09-2013.03	6MT	F	L/R	Hatchback FWD BKD/CBAB/CFFB/CLJA	Chassis no. to:8P_5A0725008P_5B001000	2032950L	Drive Shaft		36		59.5	40.5	486
	2005.06-2008.06	6DCT	F	L	Hatchback FWD BMM	Chassis no from:8P_5A1121018P_8B014001,For driving school cars	2033810L	Drive Shaft		36		59.5	40	485
	2005.06-2008.06	6DCT	F	L	Hatchback FWD BMM	Not For driving school cars	2540130L	Drive Shaft		36		59.5	40.5	482
	2005.06-2008.06	6DCT	F	R	Hatchback FWD BMM	For driving school cars	2033540L	Drive Shaft		36		59.5	40	760
	2005.06-2008.06	6DCT	F	R	Hatchback FWD BMM	Not For driving school cars	2540110L	Drive Shaft		36		59.5	40.5	760
	2005.06-2008.06	6MT	F	L	Hatchback FWD BMM		2032950L	Drive Shaft		36		59.5	40.5	486
	2005.06-2008.06	6MT	F	R	Hatchback FWD BMM	Not For driving school cars	2033130L	Drive Shaft		36		59.5	40.5	794
2.0 (105 kw)	2013.03-2016.08	6AT	F	L	Hatchback FWD CRFC		2612850L	Drive Shaft		36		59.5	40	472



		TRANSM.	F/R	L/R	BODY STYLE & DRIVE TYPE & ENGINE	REMARKS	GSP Ref.		ABS	Technical Specifications				
										A	B	C	H	L
AUDI														
A3 Sportback														
2.0 (105 kw)	2013.03-2016.08	6AT	F	R	Hatchback FWD CRFC		2033540L	Drive Shaft		36		59.5	40	760
2.0 (110 kw)	2004.09-2008.06	AT	F	R	Hatchback FWD AXX/BLR/BLX/BLY/BMB/BVY/BVZ		2610940L	Drive Shaft		36	26	59.5	40	884
	2004.09-2008.06	MT	F	L	Hatchback FWD AXX/BLR/BLX/BLY/BMB/BVY/BVZ		2032940L	Drive Shaft		36		59.5	40	517
	2004.09-2008.06	MT	F	R	Hatchback FWD AXX/BLR/BLX/BLY/BMB/BVY/BVZ		2610420L	Drive Shaft		36		59.5	40	814
	2012.09-2020.10	6DCT	F	L	Hatchback FWD CRBC/CRBL/CRUA/CSGA/DCYA/DEJA/DFGA		2612850L	Drive Shaft		36		59.5	40	472
	2012.09-2020.10	6DCT	F	R	Hatchback FWD CRBC/CRBL/CRUA/CSGA/DCYA/DEJA/DFGA		2033540L	Drive Shaft		36		59.5	40	760
	2012.09-2020.10	6MT	F	R	Hatchback FWD CRBC/CRBL/CRUA/CSGA/DCYA/DEJA/DFGA		2033130L	Drive Shaft		36		59.5	40.5	794
	2012.09-2020.10	7DCT	F	L	Hatchback FWD CRBC/CRBL/CRUA/CSGA/DCYA/DEJA/DFGA		2012650L	Drive Shaft		36	37	59.5	40	558
	2012.09-2020.10	AT	F	R	Hatchback FWD CRBC/CRBL/CRUA/CSGA/DCYA/DEJA/DFGA		2540110L	Drive Shaft		36		59.5	40.5	760
	2019.11-	6MT	F	L	Hatchback FWD DSRB/DTSA/DTSB		2032950L	Drive Shaft		36		59.5	40.5	486
	2019.11-	7DCT	F	L	Hatchback FWD DSRB/DTSA/DTSB		2012650L	Drive Shaft		36	37	59.5	40	558
2.0 (120 kw)	2006.06-2008.06	AT	F	L	Hatchback FWD BUY		2540130L	Drive Shaft		36		59.5	40.5	482
	2006.06-2008.06	AT	F	R	Hatchback FWD BUY		2540110L	Drive Shaft		36		59.5	40.5	760
	2006.06-2008.06	MT	F	L	Hatchback FWD BUY		2032950L	Drive Shaft		36		59.5	40.5	486
	2006.06-2008.06	MT	F	L	Hatchback FWD BUY		2033800L	Drive Shaft		36		59.5	40	487
2.0 (125 kw)	2006.02-2013.03	AT	F	L	Hatchback FWD BMN/CBBB/CFGB	For Engine Code:CBBB/CFGB	2033810L	Drive Shaft		36		59.5	40	485
	2006.02-2013.03	AT	F	L	Hatchback FWD BMN/CBBB/CFGB	For Engine Code:BMN	2540130L	Drive Shaft		36		59.5	40.5	482
	2006.02-2013.03	AT	F	R	Hatchback FWD BMN/CBBB/CFGB	For Engine Code:BMN/CBBB/CFGB	2540110L	Drive Shaft		36		59.5	40.5	760
	2006.02-2013.03	MT	F	L	Hatchback FWD BMN/CBBB/CFGB		2032950L	Drive Shaft		36		59.5	40.5	486
2.0 (135 kw)	2013.05-2016.08	Semi-AT	F	L	Hatchback FWD CUNA		2612850L	Drive Shaft		36		59.5	40	472
2.0 (147 kw)	2004.09-2013.03	AT	F	R	Hatchback FWD AXX/BPY/BWA/CAWB/CBFA/CCZA		2016530L	Drive Shaft		36		59.5	40.5	785
	2004.09-2013.03	AT/MT	F	L	Hatchback FWD AXX/BPY/BWA/CAWB/CBFA/CCZA		2032950L	Drive Shaft		36		59.5	40.5	486
A3 Sportback Quattro														
1.8 (118 kw)	2008.07-2013.03	7AT/6MT	F	L	Hatchback 4WD CDA	Rims:With alloy rim	2032950L	Drive Shaft		36		59.5	40.5	486
	2008.07-2013.03	7AT/6MT	F	R	Hatchback 4WD CDA		2032660L	Drive Shaft		36		59.5	40.5	601
2.0 (103 kw)	2005.11-2013.03	AT	F	R	Hatchback 4WD BKD/CBAB/CFFB		2540110L	Drive Shaft		36		59.5	40.5	760
	2005.11-2013.03	MT	F	L	Hatchback 4WD BKD/CBAB/CFFB		2032950L	Drive Shaft		36		59.5	40.5	486
	2005.11-2013.03	MT	F	L	Hatchback 4WD BKD/CBAB/CFFB		2033800L	Drive Shaft		36		59.5	40	487
	2005.11-2013.03	MT	F	R	Hatchback 4WD BKD/CBAB/CFFB	For Engine Code:BKD	2032660L	Drive Shaft		36		59.5	40.5	601
	2005.11-2013.03	MT	F	R	Hatchback 4WD BKD/CBAB/CFFB	For Engine Code:CBAB/CFFB	2033800L	Drive Shaft		36		59.5	40.5	487
	2007.06-2008.06	6AT/6MT	F	L	Hatchback 4WD BMM		2032950L	Drive Shaft		36		59.5	40.5	486
	2007.06-2008.06	6AT/6MT	F	R	Hatchback 4WD BMM		2032660L	Drive Shaft		36		59.5	40.5	601
	2007.06-2008.06	MT	F	L	Hatchback 4WD BMM		2033800L	Drive Shaft		36		59.5	40	487
2.0 (110 kw)	2013.02-2020.10	6MT	F	R	Hatchback 4WD CRBC/CRBL/DCYA		2033130L	Drive Shaft		36		59.5	40.5	794
2.0 (125 kw)	2006.02-2013.03	6AT/6MT	F	L	Hatchback 4WD BMN/CBBB/CFGB		2032950L	Drive Shaft		36		59.5	40.5	486
	2006.02-2013.03	6AT/6MT	F	R	Hatchback 4WD BMN/CBBB/CFGB		2032660L	Drive Shaft		36		59.5	40.5	601
	2006.02-2013.03	AT	F	R	Hatchback 4WD BMN/CBBB/CFGB		2540110L	Drive Shaft		36		59.5	40.5	760
	2006.02-2013.03	MT/Semi-AT	F	L	Hatchback 4WD BMN/CBBB/CFGB		2033800L	Drive Shaft		36		59.5	40	487
2.0 (135 kw)	2013.05-2020.10	6DCT	F	L	Hatchback 4WD CUNA/DGCA/DJGA		2612850L	Drive Shaft		36		59.5	40	472
	2013.05-2020.10	6DCT	F	L	Hatchback 4WD CUNA/DGCA/DJGA	For Modelcode:8VA,For PR code:2H7	2612850L	Drive Shaft		36		59.5	40	472
2.0 (147 kw)	2004.06-2013.03	6AT/6MT	F	L	Hatchback 4WD AXX/BPY/BWA/CCZA		2032950L	Drive Shaft		36		59.5	40.5	486
	2004.06-2013.03	6AT/6MT	F	R	Hatchback 4WD AXX/BPY/BWA/CCZA		2032660L	Drive Shaft		36		59.5	40.5	601
	2004.06-2013.03	MT/Semi-AT	F	L	Hatchback 4WD AXX/BPY/BWA/CCZA		2033800L	Drive Shaft		36		59.5	40	487
3.2 (184 kw)	2003.07-2009.05	AT	F	L	Hatchback 4WD BDB/BMJ/BUB	Date From:2006.06	2032950L	Drive Shaft		36		59.5	40.5	486
	2003.07-2009.05	AT/MT	F	L	Hatchback 4WD BDB/BMJ/BUB		2033800L	Drive Shaft		36		59.5	40	487
	2003.07-2009.05	AT/MT	F	R	Hatchback 4WD BDB/BMJ/BUB		2032660L	Drive Shaft		36		59.5	40.5	601
	2003.07-2009.05	MT	F	L	Hatchback 4WD BDB/BMJ/BUB		2032950L	Drive Shaft		36		59.5	40.5	486
A4														
1.4 (110 kw)	2015.08-2019.11	6MT/7DCT	F	L/R	Saloon FWD CVNA		2020750L	Drive Shaft		42		76.5	34	463
	2016.02-2019.10	6MT/7DCT	F	L/R	Estate FWD CVNA		2020750L	Drive Shaft		42		76.5	34	463
1.8 (88 kw)	2008.01-2015.12	CVT/6MT	F	L/R	Saloon FWD CABA/CDHA	Date to:2011.10	2032730L	Drive Shaft		42		76.5	34	460
	2008.06-2015.12	CVT/6MT	F	L/R	Estate FWD CDHA	Date to:2011.10	2032730L	Drive Shaft		42		76.5	34	460
1.8 (118 kw)	2007.11-2012.03	CVT/6MT	F	L/R	Saloon FWD CABB/CDHB	Date to:2011.10	2032730L	Drive Shaft		42		76.5	34	460
	2007.11-2012.03	CVT/6MT	F	L/R	Saloon FWD CABB/CDHB	Date to:2011.10	2032730L	Drive Shaft		42		76.5	34	460
2.0 (88 kw)	2008.06-2015.12	6MT	F	L/R	Estate FWD CAGC/CJCC	Date to:2011.10,For PR code:1BA/1BE/1BL/1BD/1BV	2032730L	Drive Shaft		42		76.5	34	460
	2008.06-2015.12	6MT	F	L/R	Saloon FWD CAGC/CJCC	Date to:2011.10,For PR code:1BA/1BE/1BL/1BD/1BV	2032730L	Drive Shaft		42		76.5	34	460
2.0 (90 kw)	2016.04-2019.10	6MT/7DCT	F	L/R	Estate FWD DEUC		2020750L	Drive Shaft		42		76.5	34	463
	2016.05-2019.09	6MT/7DCT	F	L/R	Saloon FWD DEUC		2020750L	Drive Shaft		42		76.5	34	463
2.0 (100 kw)	2007.11-2015.12	CVT/6MT	F	L/R	Saloon FWD CAGB/CJCB/CSUB	Date to:2011.10,For PR code:1BA/1BE/1BL/1BD/1BV	2032730L	Drive Shaft		42		76.5	34	460
	2008.04-2015.12	CVT/6MT	F	L/R	Estate FWD CAGB/CJCB/CSUB	Date to:2011.10,For PR code:1BA/1BE/1BL/1BD/1BV	2032730L	Drive Shaft		42		76.5	34	460
	2015.05-2019.11	6MT/7DCT	F	L/R	Saloon FWD DEUB		2020750L	Drive Shaft		42		76.5	34	463
	2015.08-2019.10	6MT/7DCT	F	L/R	Estate FWD DEUB		2020750L	Drive Shaft		42		76.5	34	463
	2019.07-	7AT	F	L/R	Estate FWD DEZB/DTNB		2022560L	Drive Shaft		42		76.5	34	464
	2019.07-	7AT	F	L/R	Saloon FWD DEZB/DTNB		2022560L	Drive Shaft		42		76.5	34	464
2.0 (105 kw)	2007.11-2015.12	CVT/6MT	F	L/R	Saloon FWD CAGA/CJCA/CMEA/CMFA	Date to:2011.10,For PR code:1BA/1BE/1BL/1BD/1BV	2032730L	Drive Shaft		42		76.5	34	460





		TRANSM.	F/R	L/R	BODY STYLE & DRIVE TYPE & ENGINE	REMARKS	GSP Ref.		Technical Specifications				
									PRODUCT	ABS	A	B	C
AUDI A4													
2.0 (105 kw)	2008.04-2015.12	CVT/6MT	F	L/R	Estate FWD CAGA/CJCA/CMEA/CMFA	Date to:2011.10.For PR code:1BA/1BE/1BL/1BD/1BV	2032730L	Drive Shaft	42	76.5	34	460	
2.0 (110 kw)	2015.05-2019.11	6MT/7DCT	F	L/R	Saloon FWD CZHA/DEUA		2020750L	Drive Shaft	42	76.5	34	463	
	2015.08-2019.10	6MT/7DCT	F	L/R	Estate FWD CZHA/DEUA		2020750L	Drive Shaft	42	76.5	34	463	
	2018.12-	6MT/7DCT	F	L/R	Estate FWD DLVB/DMSB		2020750L	Drive Shaft	42	76.5	34	463	
	2018.12-	6MT/7DCT	F	L/R	Saloon FWD DLVB/DMSB		2020750L	Drive Shaft	42	76.5	34	463	
2.0 (120 kw)	2008.08-2015.12	CVT/6MT	F	L/R	Estate FWD CAHB/CGLD/CNHC		2032730L	Drive Shaft	42	76.5	34	460	
	2008.08-2015.12	CVT/6MT	F	L/R	Saloon FWD CAHB/CGLD/CNHC		2032730L	Drive Shaft	42	76.5	34	460	
	2019.07-	7AT	F	L/R	Estate FWD DEZE/DTNA		2022560L	Drive Shaft	42	76.5	34	464	
	2019.07-	7AT	F	L/R	Saloon FWD DEZE/DTNA		2022560L	Drive Shaft	42	76.5	34	464	
2.0 (125 kw)	2008.04-2012.03	6MT	F	L/R	Estate FWD CAHA	Date to:2011.10.For PR code:1BA/1BE/1BL/1BD/1BV	2032730L	Drive Shaft	42	76.5	34	460	
	2008.08-2012.03	6MT	F	L/R	Saloon FWD CAHA	Date to:2011.10.For PR code:1BA/1BE/1BL/1BD/1BV	2032730L	Drive Shaft	42	76.5	34	460	
	2016.11-2019.10	6MT/7DCT	F	L/R	Estate FWD CVLA		2020750L	Drive Shaft	42	76.5	34	463	
2.0 (130 kw)	2011.11-2015.12	CVT/6MT	F	L/R	Estate FWD CGLC		2032730L	Drive Shaft	42	76.5	34	460	
	2011.11-2015.12	CVT/6MT	F	L/R	Saloon FWD CGLC		2032730L	Drive Shaft	42	76.5	34	460	
2.0 (132 kw)	2008.06-2015.12	CVT/6MT	F	L/R	Estate FWD CDN/CFKA	Date to:2011.10.For PR code:1BA/1BE/1BL/1BD/1BV	2032730L	Drive Shaft	42	76.5	34	460	
	2008.06-2015.12	CVT/6MT	F	L/R	Saloon FWD CDN/CFKA	Date to:2011.10.For PR code:1BA/1BE/1BL/1BD/1BV	2032730L	Drive Shaft	42	76.5	34	460	
	2009.11-2015.12	6MT	F	L/R	Estate FWD CFKA	Date to:2011.10.For PR code:1BA/1BE/1BL/1BD/1BV	2032730L	Drive Shaft	42	76.5	34	460	
	2009.11-2015.12	6MT	F	L/R	Saloon FWD CFKA	Date to:2011.10.For PR code:1BA/1BE/1BL/1BD/1BV	2032730L	Drive Shaft	42	76.5	34	460	
2.0 (140 kw)	2013.09-2015.12	CVT/6MT	F	L/R	Estate FWD CNHA		2032730L	Drive Shaft	42	76.5	34	460	
	2013.09-2015.12	CVT/6MT	F	L/R	Saloon FWD CNHA		2032730L	Drive Shaft	42	76.5	34	460	
	2015.05-	6MT/7AT	F	L/R	Saloon FWD DESA/DETA/DFVA	Date from:2016.02	2022560L	Drive Shaft	42	76.5	34	464	
	2015.05-	7AT/6MT	F	L/R	Saloon FWD DESA/DETA/DFVA	Date to:2016.01	2020740L	Drive Shaft	42	76.5	34	464	
	2015.05-2019.11	6MT/7DCT	F	L/R	Saloon FWD CVKB/DBPA		2020750L	Drive Shaft	42	76.5	34	463	
	2015.08-	6MT/7DCT	F	L/R	Estate FWD CVKB/DBPA		2020750L	Drive Shaft	42	76.5	34	463	
	2015.08-	6MT/7AT	F	L/R	Estate FWD DESA/DETA/DFVA	Date from:2016.02	2022560L	Drive Shaft	42	76.5	34	464	
	2015.08-	7AT/6MT	F	L/R	Estate FWD DESA/DETA/DFVA	Date to:2016.01	2020740L	Drive Shaft	42	76.5	34	464	
	2017.05-	6MT/7DCT	F	L/R	Estate FWD DEMA/DKYA/DLVA	For Enginecode:DEMA/DKYA	2020750L	Drive Shaft	42	76.5	34	463	
	2017.05-	7AT/6MT	F	L/R	Estate FWD DEMA/DKYA/DLVA	For Engine code:DLVA	2022560L	Drive Shaft	42	76.5	34	464	
	2017.05-	6MT/7AT	F	L/R	Saloon FWD DEMA/DKYA/DLVA	For Enginecode:DLVA	2022560L	Drive Shaft	42	76.5	34	464	
	2017.05-	6MT/7DCT	F	L/R	Saloon FWD DEMA/DKYA/DLVA	For Enginecode:DEMA/DKYA	2020750L	Drive Shaft	42	76.5	34	463	
2.0 (155 kw)	2008.06-2013.05	CVT/6MT	F	L/R	Estate FWD CDNC	Date to:2011.10.For PR code:1BA/1BE/1BL/1BD/1BV	2032730L	Drive Shaft	42	76.5	34	460	
	2008.06-2015.12	CVT/6MT	F	L/R	Saloon FWD CAEB/CDNC	Date to:2011.10.For PR code:1BA/1BE/1BL/1BD/1BV	2032730L	Drive Shaft	42	76.5	34	460	
2.0 (180 kw)	2018.07-2019.10	7AT	F	L/R	Estate FWD DKNA		2022560L	Drive Shaft	42	76.5	34	464	
	2018.07-2019.11	7AT	F	L/R	Saloon FWD DKNA		2022560L	Drive Shaft	42	76.5	34	464	
2.0 (183 kw)	2015.11-2019.11	7AT	F	L/R	Saloon FWD CYRC	Date from:2016.02	2022560L	Drive Shaft	42	76.5	34	464	
2.0 (185 kw)	2015.08-2019.11	7AT	F	L/R	Saloon FWD CYMC/CYRB	Date from:2016.02	2022560L	Drive Shaft	42	76.5	34	464	
	2017.05-2019.10	7AT	F	L/R	Estate FWD DDWA		2022560L	Drive Shaft	42	76.5	34	464	
	2017.05-2019.11	7AT	F	L/R	Saloon FWD DDWA		2022560L	Drive Shaft	42	76.5	34	464	
2.7 (120 kw)	2007.11-2012.03	CVT	F	L/R	Saloon FWD CAMB/CGKB	Date from:2011.11	2032730L	Drive Shaft	42	76.5	34	460	
	2008.04-2012.03	CVT	F	L/R	Estate FWD CAMB/CGKB	Date from:2011.11	2032730L	Drive Shaft	42	76.5	34	460	
2.7 (140 kw)	2007.11-2012.03	CVT/6MT	F	L/R	Saloon FWD CAMA/CGKA	Date from:2011.11	2032730L	Drive Shaft	42	76.5	34	460	
	2008.04-2012.03	CVT/6MT	F	L/R	Estate FWD CAMA/CGKA	Date from:2011.11	2032730L	Drive Shaft	42	76.5	34	460	
3.0 (150 kw)	2011.11-2015.12	CVT/6MT	F	L/R	Estate FWD CLAB		2032730L	Drive Shaft	42	76.5	34	460	
	2011.11-2015.12	CVT/6MT	F	L/R	Saloon FWD CLAB		2032730L	Drive Shaft	42	76.5	34	460	
3.0 (160 kw)	2015.09-2018.08	7AT	F	L/R	Saloon FWD CSWB	Date from:2016.02	2022560L	Drive Shaft	42	76.5	34	464	
	2015.10-2018.08	7AT	F	L/R	Estate FWD CSWB	Date from:2016.02	2022560L	Drive Shaft	42	76.5	34	464	
3.2 (195 kw)	2008.09-2012.03	CVT	F	L/R	Estate FWD CALA	Date to:2011.10.For PR code:1BA/1BE/1BL	2032730L	Drive Shaft	42	76.5	34	460	
	2008.09-2012.03	CVT	F	L/R	Saloon FWD CALA	Date to:2011.10.For PR code:1BA/1BE/1BL	2032730L	Drive Shaft	42	76.5	34	460	
A4 Allroad Quattro													
2.0 (100 kw)	2009.09-2016.05	MT	F	L/R	Estate 4WD CAGB/CJCB/CSUB	Code:CJCB/CSUB	2033710L	Drive Shaft	42	76.5	34	464	
	2016.11-2018.07	6MT	F	L/R	Estate 4WD DEUB	For PR code:GH1	2020740L	Drive Shaft	42	76.5	34	464	
	2016.11-2018.07	6MT	F	L/R	Estate 4WD DEUB	For PR code:GH4.For vehicles with AWD & variable torque dist.	2020750L	Drive Shaft	42	76.5	34	463	
	2016.11-2018.07	6MT	R	L/R	Estate 4WD DEUB	For PR code:GH1	2023630L	Drive Shaft	38		34	624	
2.0 (105 kw)	2009.09-2016.05	7AT/6MT	F	L/R	Estate 4WD CAGA/CJCA	For Engine Code:CJCA	2033710L	Drive Shaft	42	76.5	34	464	
2.0 (110 kw)	2013.05-2016.05	6MT	F	L/R	Estate 4WD CJCD/CSUA		2033710L	Drive Shaft	42	76.5	34	464	
	2016.11-2019.10	6MT	F	L/R	Estate 4WD DEUA	For PR code:GH1	2020740L	Drive Shaft	42	76.5	34	464	
	2016.11-2019.10	6MT	F	L/R	Estate 4WD DEUA	For PR code:GH4.For vehicles with AWD & variable torque dist.	2020750L	Drive Shaft	42	76.5	34	463	
	2016.11-2019.10	6MT	R	L/R	Estate 4WD DEUA	For PR code:GH1	2023630L	Drive Shaft	38		34	624	
2.0 (120 kw)	2009.04-2016.05	7AT/6MT	F	L/R	Estate 4WD CAHB/CGLD/CNHC	Date From:2012.08.Code:CGLD/CNHC	2033710L	Drive Shaft	42	76.5	34	464	
	2016.05-2019.10	7AT	F	L/R	Estate 4WD DETB	For PR code:GH1	2020740L	Drive Shaft	42	76.5	34	464	
	2016.05-2019.10	7DCT	F	L/R	Estate 4WD DETB	For PR code:GH4.For vehicles with AWD & variable torque dist.	2020750L	Drive Shaft	42	76.5	34	463	
	2016.05-2019.10	7DCT	R	L/R	Estate 4WD DETB	For PR code:GH1	2023630L	Drive Shaft	38		34	624	
2.0 (130 kw)	2011.11-2016.05	7AT/6MT	F	L/R	Estate 4WD CGLC		2033710L	Drive Shaft	42	76.5	34	464	
2.0 (140 kw)	2013.09-2016.05	7AT/6MT	F	L/R	Estate 4WD CNHA		2033710L	Drive Shaft	42	76.5	34	464	
	2016.01-	6MT/7DCT	F	L/R	Estate 4WD DESA/DETA/DFVA	For PR code:GH4.For vehicles with AWD & variable torque dist.	2020750L	Drive Shaft	42	76.5	34	463	



	 YEAR	TRANSM.	F/R	L/R	BODY STYLE & DRIVE TYPE & ENGINE	REMARKS	GSP Ref.	 PRODUCT	 ABS	Technical Specifications				
										A	B	C	H	L
AUDI														
A4 Allroad Quattro														
2.0 (140 kw)	2016.01-	7AT/6MT	F	L/R	Estate 4WD DESA/DETA/DFVA	Date From:2016.02,For PR code:GH1	202740L	Drive Shaft		42		76.5	34	464
	2016.01-	6MT/7DCT	R	L/R	Estate 4WD DESA/DETA/DFVA	For PR code:GH1	2023630L	Drive Shaft		38			34	624
2.0 (150 kw)	2020.09-	7DCT	R	L/R	Estate 4WD DTPA	For PR code:GH1	2023630L	Drive Shaft		38			34	624
2.0 (155 kw)	2009.04-2016.05	7AT/8AT/6MT	F	L/R	Estate 4WD CDNC/CPMA	For Engine Code:CDNC	2033710L	Drive Shaft		42		76.5	34	464
2.0 (162 kw)	2012.03-2016.05	8AT	F	L/R	Estate 4WD CPMB		2033710L	Drive Shaft		42		76.5	34	464
2.0 (165 kw)	2013.05-2016.05	CVT/7AT/6MT	F	L/R	Estate 4WD CNCD		2033710L	Drive Shaft		42		76.5	34	464
2.0 (180 kw)	2018.07-	7AT	F	L/R	Estate 4WD DKNA	For PR code:GH1	202740L	Drive Shaft		42		76.5	34	464
	2018.07-	7DCT	F	L/R	Estate 4WD DKNA	For PR code:GH4,For vehicles with AWD & variable torque dist.	202750L	Drive Shaft		42		76.5	34	463
	2018.07-	7DCT	R	L/R	Estate 4WD DKNA	For PR code:GH1	2023630L	Drive Shaft		38			34	624
2.0 (183 kw)	2016.05-2019.10	7AT	F	L/R	Estate 4WD CYRC	For PR code:GH1	202740L	Drive Shaft		42		76.5	34	464
	2016.05-2019.10	7DCT	F	L/R	Estate 4WD CYRC	For PR code:GH4,For vehicles with AWD & variable torque dist.	202750L	Drive Shaft		42		76.5	34	463
	2016.05-2019.10	7DCT	R	L/R	Estate 4WD CYRC	For PR code:GH1	2023630L	Drive Shaft		38			34	624
2.0 (185 kw)	2016.01-2019.10	7AT	F	L/R	Estate 4WD CYMC/CYRB	Date From:2016.02,For PR code:GH1	202740L	Drive Shaft		42		76.5	34	464
	2016.01-2019.10	7DCT	F	L/R	Estate 4WD CYMC/CYRB	For PR code:GH4,For vehicles with AWD & variable torque dist.	202750L	Drive Shaft		42		76.5	34	463
	2016.01-2019.10	7DCT	R	L/R	Estate 4WD CYMC/CYRB	For PR code:GH1	2023630L	Drive Shaft		38			34	624
	2018.11-2019.10	7AT	F	L/R	Estate 4WD DDWA	For PR code:GH1	202740L	Drive Shaft		42		76.5	34	464
	2018.11-2019.10	7DCT	F	L/R	Estate 4WD DDWA	For PR code:GH4,For vehicles with AWD & variable torque dist.	202750L	Drive Shaft		42		76.5	34	463
	2018.11-2019.10	7DCT	R	L/R	Estate 4WD DDWA	For PR code:GH1	2023630L	Drive Shaft		38			34	624
2.0 (195 kw)	2020.08-	7DCT	R	L/R	Estate 4WD DMTA	For PR code:GH1	2023630L	Drive Shaft		38			34	624
3.0 (160 kw)	2016.01-2018.08	7DCT	F	L/R	Estate 4WD CSWB		202750L	Drive Shaft		42		76.5	34	463
3.0 (170 kw)	2019.07-	8AT	F	L/R	Estate 4WD DCPE		202750L	Drive Shaft		42		76.5	34	463
3.0 (200 kw)	2016.01-2018.08	8AT	F	L/R	Estate 4WD CRTC		202750L	Drive Shaft		42		76.5	34	463
3.0 (210 kw)	2018.07-	8AT	F	L/R	Estate 4WD DCPC		202750L	Drive Shaft		42		76.5	34	463
A4 Quattro														
1.8 (125 kw)	2011.11-2015.12	6MT	F	L/R	Estate 4WD CJEB		2033710L	Drive Shaft		42		76.5	34	464
	2011.11-2015.12	6MT	F	L/R	Saloon 4WD CJEB		2033710L	Drive Shaft		42		76.5	34	464
2.0 (105 kw)	2008.11-2015.12	6MT	F	L/R	Estate 4WD CAGA/CJCA	Date From:2008.11,Chassis no. from:8KD000001	2033710L	Drive Shaft		42		76.5	34	464
	2009.05-2015.12	6MT	F	L/R	Saloon 4WD CAGA/CJCA	Date From:2009.05,Chassis no. from:8KD000001	2033710L	Drive Shaft		42		76.5	34	464
2.0 (110 kw)	2011.11-2015.12	6MT	F	L/R	Saloon 4WD CJCD/CSUA		2033710L	Drive Shaft		42		76.5	34	464
	2013.05-2015.12	6MT	F	L/R	Estate 4WD CJCD/CSUA		2033710L	Drive Shaft		42		76.5	34	464
	2016.09-2019.10	6MT	F	L/R	Estate 4WD DEUA	For PR code:GH1	202740L	Drive Shaft		42		76.5	34	464
	2016.09-2019.10	6MT	F	L/R	Estate 4WD DEUA	For PR code:GH4,For vehicles with AWD & variable torque dist.	202750L	Drive Shaft		42		76.5	34	463
	2016.09-2019.10	6MT	R	L/R	Estate 4WD DEUA	For PR code:GH1	2023630L	Drive Shaft		38			34	624
	2016.09-2019.11	6MT	F	L/R	Saloon 4WD DEUA	For PR code:GH1	202740L	Drive Shaft		42		76.5	34	464
	2016.09-2019.11	6MT	F	L/R	Saloon 4WD DEUA	For PR code:GH4,For vehicles with AWD & variable torque dist.	202750L	Drive Shaft		42		76.5	34	463
	2016.09-2019.11	6MT	R	L/R	Saloon 4WD DEUA	For PR code:GH1	2023630L	Drive Shaft		38			34	624
2.0 (120 kw)	2016.09-2018.09	7AT	F	L/R	Estate 4WD DETB	For PR code:GH1	202740L	Drive Shaft		42		76.5	34	464
	2016.09-2018.09	7DCT	F	L/R	Estate 4WD DETB	For PR code:GH4,For vehicles with AWD & variable torque dist.	202750L	Drive Shaft		42		76.5	34	463
	2016.09-2018.09	7DCT	R	L/R	Estate 4WD DETB	For PR code:GH1	2023630L	Drive Shaft		38			34	624
	2016.09-2019.11	7AT	F	L/R	Saloon 4WD DETB	For PR code:GH1	202740L	Drive Shaft		42		76.5	34	464
	2016.09-2019.11	7DCT	F	L/R	Saloon 4WD DETB	For PR code:GH4,For vehicles with AWD & variable torque dist.	202750L	Drive Shaft		42		76.5	34	463
	2016.09-2019.11	7DCT	R	L/R	Saloon 4WD DETB	For PR code:GH1	2023630L	Drive Shaft		38			34	624
2.0 (130 kw)	2011.11-2015.12	7AT/6MT	F	L/R	Estate 4WD CGLC		2033710L	Drive Shaft		42		76.5	34	464
	2011.11-2015.12	7AT/6MT	F	L/R	Saloon 4WD CGLC		2033710L	Drive Shaft		42		76.5	34	464
2.0 (132 kw)	2009.11-2013.03	6MT	F	L/R	Saloon 4WD CFKA	Chassis no. from:8KD000001	2033710L	Drive Shaft		42		76.5	34	464
	2009.11-2015.12	6MT	F	L/R	Estate 4WD CFKA	Chassis no. from:8KD000001	2033710L	Drive Shaft		42		76.5	34	464
	2009.11-2015.12	6MT	F	L/R	Saloon 4WD CFKA	Chassis no. from:8KD000001	2033710L	Drive Shaft		42		76.5	34	464
2.0 (140 kw)	2013.09-2015.12	7AT/6MT	F	L/R	Estate 4WD CNHA		2033710L	Drive Shaft		42		76.5	34	464
	2013.09-2015.12	7AT/6MT	F	L/R	Saloon 4WD CNHA		2033710L	Drive Shaft		42		76.5	34	464
	2015.09-	6MT/7DCT	F	L/R	Saloon 4WD DESA/DETA/DFVA	For PR code:GH4,For vehicles with AWD & variable torque dist.	202750L	Drive Shaft		42		76.5	34	463
	2015.09-	7AT/6MT	F	L/R	Saloon 4WD DESA/DETA/DFVA	Date From:2016.02,For PR code:GH1	202740L	Drive Shaft		42		76.5	34	464
	2015.09-	6MT/7DCT	R	L/R	Saloon 4WD DESA/DETA/DFVA	For PR code:GH1	2023630L	Drive Shaft		38			34	624
	2015.10-2020.09	6MT/7DCT	F	L/R	Estate 4WD DESA/DETA/DFVA	For PR code:GH4,For vehicles with AWD & variable torque dist.	202750L	Drive Shaft		42		76.5	34	463
	2015.10-2020.09	7AT/6MT	F	L/R	Estate 4WD DESA/DETA/DFVA	Date From:2016.02,For PR code:GH1	202740L	Drive Shaft		42		76.5	34	464
	2015.10-2020.09	6MT/7DCT	R	L/R	Estate 4WD DESA/DETA/DFVA	For PR code:GH1	2023630L	Drive Shaft		38			34	624
2.0 (150 kw)	2020.05-	7DCT	R	L/R	Estate 4WD DTPA	For PR code:GH1	2023630L	Drive Shaft		38			34	624
	2020.05-	7DCT	R	L/R	Saloon 4WD DTPA	For PR code:GH1	2023630L	Drive Shaft		38			34	624
	2020.06-	7DCT	R	L/R	Estate 4WD DMSA	For PR code:GH1	2023630L	Drive Shaft		38			34	624
	2020.06-	7DCT	R	L/R	Saloon 4WD DMSA	For PR code:GH1	2023630L	Drive Shaft		38			34	624
2.0 (155 kw)	2008.06-2015.12	7AT/6MT	F	L/R	Estate 4WD CDNC	Chassis no. from:8KD000001	2033710L	Drive Shaft		42		76.5	34	464
	2008.06-2015.12	7AT/8AT/6MT	F	L/R	Saloon 4WD CAEB/CDNC/CPMA	Chassis no. from:8KD000001	2033710L	Drive Shaft		42		76.5	34	464
2.0 (162 kw)	2012.03-2015.12	8AT	F	L/R	Saloon 4WD CAED/CPMB		2033710L	Drive Shaft		42		76.5	34	464
2.0 (165 kw)	2013.05-2015.12	7AT/6MT	F	L/R	Estate 4WD CNCD		2033710L	Drive Shaft		42		76.5	34	464
	2013.05-2015.12	7AT/6MT	F	L/R	Saloon 4WD CNCD		2033710L	Drive Shaft		42		76.5	34	464
2.0 (180 kw)	2018.07-	7AT	F	L/R	Estate 4WD DKNA	For PR code:GH1	202740L	Drive Shaft		42		76.5	34	464



	 YEAR	TRANSM.	F/R	L/R	BODY STYLE & DRIVE TYPE & ENGINE	REMARKS	GSP Ref.	 PRODUCT	 ABS	Technical Specifications				
										A	B	C	H	L
AUDI														
A4 Quattro														
2.0 (180 kw)	2018.07-	7DCT	F	L/R	Estate 4WD DKNA	For PR code:GH1	2020750L	Drive Shaft		42		76.5	34	463
	2018.07-	7DCT	R	L/R	Estate 4WD DKNA	For PR code:GH1	2023630L	Drive Shaft		38			34	624
	2018.07-	7AT	F	L/R	Saloon 4WD DKNA	For PR code:GH1	2020740L	Drive Shaft		42		76.5	34	464
	2018.07-	7DCT	F	L/R	Saloon 4WD DKNA	For PR code:GH1	2020750L	Drive Shaft		42		76.5	34	463
	2018.07-	7DCT	R	L/R	Saloon 4WD DKNA	For PR code:GH1	2023630L	Drive Shaft		38			34	624
2.0 (183 kw)	2015.11-2019.10	7AT	F	L/R	Estate 4WD CYRC	Date From:2016.02,For PR code:GH1	2020740L	Drive Shaft		42		76.5	34	464
	2015.11-2019.10	7DCT	F	L/R	Estate 4WD CYRC	For PR code:GH1	2020750L	Drive Shaft		42		76.5	34	463
	2015.11-2019.10	7DCT	R	L/R	Estate 4WD CYRC	For PR code:GH1	2023630L	Drive Shaft		38			34	624
	2015.11-2019.11	7AT	F	L/R	Saloon 4WD CYRC	Date From:2016.02,For PR code:GH1	2020740L	Drive Shaft		42		76.5	34	464
	2015.11-2019.11	7DCT	F	L/R	Saloon 4WD CYRC	For PR code:GH1	2020750L	Drive Shaft		42		76.5	34	463
	2015.11-2019.11	7DCT	R	L/R	Saloon 4WD CYRC	For PR code:GH1	2023630L	Drive Shaft		38			34	624
	2015.11-2019.11	7DCT	R	L/R	Saloon 4WD CYRC	For PR code:GH1	2020750L	Drive Shaft		42		76.5	34	463
2.0 (185 kw)	2015.05-2019.11	6MT/7DCT	F	L/R	Saloon 4WD CYMC/CYRB	For PR code:GH1	2020750L	Drive Shaft		42		76.5	34	463
	2015.05-2019.11	7AT/6MT	F	L/R	Saloon 4WD CYMC/CYRB	Date From:2016.02,For PR code:GH1	2020740L	Drive Shaft		42		76.5	34	464
	2015.05-2019.11	6MT/7DCT	R	L/R	Saloon 4WD CYMC/CYRB	For PR code:GH1	2023630L	Drive Shaft		38			34	624
	2015.08-2019.10	6MT/7DCT	F	L/R	Estate 4WD CYRB	For PR code:GH1	2020750L	Drive Shaft		42		76.5	34	463
	2015.08-2019.10	7AT/6MT	F	L/R	Estate 4WD CYRB	Date From:2016.02,For PR code:GH1	2020740L	Drive Shaft		42		76.5	34	464
	2015.08-2019.10	6MT/7DCT	R	L/R	Estate 4WD CYRB	For PR code:GH1	2023630L	Drive Shaft		38			34	624
	2017.05-2019.10	7AT	F	L/R	Estate 4WD DDWA	For PR Code:GH1	2020740L	Drive Shaft		42		76.5	34	464
	2017.05-2019.10	7DCT	F	L/R	Estate 4WD DDWA	For PR code:GH1	2020750L	Drive Shaft		42		76.5	34	463
	2017.05-2019.10	7DCT	R	L/R	Estate 4WD DDWA	For PR code:GH1	2023630L	Drive Shaft		38			34	624
	2017.05-2019.11	7AT	F	L/R	Saloon 4WD DDWA	For PR Code:GH1	2020740L	Drive Shaft		42		76.5	34	464
	2017.05-2019.11	7DCT	F	L/R	Saloon 4WD DDWA	For PR code:GH1	2020750L	Drive Shaft		42		76.5	34	463
	2017.05-2019.11	7DCT	R	L/R	Saloon 4WD DDWA	For PR code:GH1	2023630L	Drive Shaft		38			34	624
	2017.05-2019.11	7DCT	R	L/R	Saloon 4WD DDWA	For PR code:GH1	2020750L	Drive Shaft		42		76.5	34	463
2.0 (195 kw)	2020.08-	7DCT	R	L/R	Estate 4WD DMTA	For PR code:GH1	2023630L	Drive Shaft		38			34	624
	2020.08-	7DCT	R	L/R	Saloon 4WD DMTA	For PR code:GH1	2023630L	Drive Shaft		38			34	624
3.0 (155 kw)	2008.06-2010.05	6AT/7DCT	F	L/R	Estate 4WD CCWB		2032730L	Drive Shaft		42		76.5	34	460
	2008.06-2010.05	6AT/7DCT	F	L/R	Saloon 4WD CCWB		2032730L	Drive Shaft		42		76.5	34	460
3.0 (160 kw)	2015.09-2018.08	7DCT	F	L/R	Saloon 4WD CSWB		2020750L	Drive Shaft		42		76.5	34	463
	2015.11-2018.08	7DCT	F	L/R	Estate 4WD CSWB		2020750L	Drive Shaft		42		76.5	34	463
3.0 (170 kw)	2018.07-	8AT	F	L/R	Estate 4WD DCPE		2020750L	Drive Shaft		42		76.5	34	463
	2018.07-	8AT	F	L/R	Saloon 4WD DCPE		2020750L	Drive Shaft		42		76.5	34	463
3.0 (176 kw)	2007.11-2012.03	6AT/7DCT/6MT	F	L/R	Saloon 4WD CAPA/CCLA/CCWA	Date to:2011.10	2032730L	Drive Shaft		42		76.5	34	460
	2008.04-2012.03	6AT/7DCT/6MT	F	L/R	Estate 4WD CAPA/CCLA/CCWA	Date to:2011.10	2032730L	Drive Shaft		42		76.5	34	460
3.0 (200 kw)	2015.05-2018.08	8AT	F	L/R	Saloon 4WD CRTC		2020750L	Drive Shaft		42		76.5	34	463
	2015.08-2018.08	8AT	F	L/R	Estate 4WD CRTC		2020750L	Drive Shaft		42		76.5	34	463
3.0 (210 kw)	2018.07-2019.10	8AT	F	L/R	Estate 4WD DCPC		2020750L	Drive Shaft		42		76.5	34	463
	2018.07-2020.08	8AT	F	L/R	Saloon 4WD DCPC		2020750L	Drive Shaft		42		76.5	34	463
A5														
1.4 (110 kw)	2016.11-2020.02	7DCT	F	L/R	Coupe FWD CVNA		2020750L	Drive Shaft		42		76.5	34	463
1.8 (118 kw)	2009.05-2011.09	CVT/6MT	F	L/R	Coupe FWD CDHB		2032730L	Drive Shaft		42		76.5	34	460
1.8 (125 kw)	2007.10-2017.01	CVT/6MT	F	L/R	Coupe FWD CABD/CJEB	For Engine code:CABD	2032730L	Drive Shaft		42		76.5	34	460
2.0 (100 kw)	2019.10-	7AT	F	L/R	Coupe FWD DEZB		202560L	Drive Shaft		42		76.5	34	464
2.0 (110 kw)	2017.05-2020.02	6MT/7DCT	F	L/R	Coupe FWD CZHA/DEUA		2020750L	Drive Shaft		42		76.5	34	463
	2019.02-	6MT/7DCT	F	L/R	Coupe FWD DLVB/DMSB	For Enginecode:DMSB/DLVB	2020750L	Drive Shaft		42		76.5	34	463
	2020.03-	7DCT	F	L/R	Coupe FWD CVKC/DEMB		2020750L	Drive Shaft		42		76.5	34	463
2.0 (120 kw)	2008.08-2017.01	CVT/6MT	F	L/R	Coupe FWD CAHB/CGLD/CNHC	Date to:2011.10,For Engine code:CNHC,Date from:2011.10,For Engine code:CGLD/CNHC	2032730L	Drive Shaft		42		76.5	34	460
	2019.03-	7AT	F	L/R	Coupe FWD DEZE/DTNA		202560L	Drive Shaft		42		76.5	34	464
2.0 (125 kw)	2008.08-2012.02	6MT	F	L/R	Coupe FWD CAHA	Date to:2011.10	2032730L	Drive Shaft		42		76.5	34	460
2.0 (130 kw)	2011.08-2017.01	CVT/6MT	F	L/R	Coupe FWD CGLC		2032730L	Drive Shaft		42		76.5	34	460
2.0 (132 kw)	2008.09-2012.03	CVT/6MT	F	L/R	Coupe FWD CDNB	Date to:2011.10	2032730L	Drive Shaft		42		76.5	34	460
2.0 (140 kw)	2013.09-2017.01	CVT/6MT	F	L/R	Coupe FWD CNHA		2032730L	Drive Shaft		42		76.5	34	460
	2016.06-	6MT/7AT	F	L/R	Coupe FWD DESA/DETA		202560L	Drive Shaft		42		76.5	34	464
	2016.08-2020.02	6MT/7DCT	F	L/R	Coupe FWD CVKB		2020750L	Drive Shaft		42		76.5	34	463
	2017.05-	6MT/7DCT	F	L/R	Coupe FWD DEMA/DHDA/DKVA/DLVA	For Engine code:DEMA/DKVA/DHDA/DLVA	2020750L	Drive Shaft		42		76.5	34	463
2.0 (150 kw)	2020.07-	7DCT	F	L/R	Coupe FWD DMSA		2020750L	Drive Shaft		42		76.5	34	463
	2020.09-	7AT	F	L/R	Coupe FWD DTPA		202560L	Drive Shaft		42		76.5	34	464
2.0 (155 kw)	2008.06-2013.11	CVT/6MT	F	L/R	Coupe FWD CDNC	Date to:2011.10	2032730L	Drive Shaft		42		76.5	34	460
2.0 (180 kw)	2018.07-2020.02	7AT	F	L/R	Coupe FWD DKNA		202560L	Drive Shaft		42		76.5	34	464
2.0 (185 kw)	2017.05-2020.02	7AT	F	L/R	Coupe FWD DDWA		202560L	Drive Shaft		42		76.5	34	464
2.7 (120 kw)	2007.09-2012.02	CVT	F	L/R	Coupe FWD CAMB/CGKB	Date from:2011.11	2032730L	Drive Shaft		42		76.5	34	460
2.7 (140 kw)	2007.07-2012.02	CVT/6MT	F	L/R	Coupe FWD CAMA/CGKA	Date from:2011.11	2032730L	Drive Shaft		42		76.5	34	460
3.0 (150 kw)	2011.10-2017.01	CVT/6MT	F	L/R	Coupe FWD CLAB		2032730L	Drive Shaft		42		76.5	34	460
3.2 (195 kw)	2007.06-2012.03	CVT	F	L/R	Coupe FWD CALA	Checked by:WST_A_01000,Date to:2011.10,Checked by:WST_A_01001	2032730L	Drive Shaft		42		76.5	34	460



	 YEAR	TRANSM.	F/R	L/R	BODY STYLE & DRIVE TYPE & ENGINE	REMARKS	GSP Ref.	 PRODUCT	 ABS	Technical Specifications				
										A	B	C	H	L
AUDI														
A5 Cabrio														
1.8 (118 kw)	2009.09-2012.03	CVT/6MT	F	L/R	Cabriolet FWD CDHB	Date to:2011.10	2032730L	Drive Shaft		42		76.5	34	460
2.0 (100 kw)	2018.07-2019.12	7AT	F	L/R	Cabriolet FWD DEZB		2022560L	Drive Shaft		42		76.5	34	464
2.0 (110 kw)	2017.08-2019.12	6MT/7DCT	F	L/R	Cabriolet FWD DEUA		2020750L	Drive Shaft		42		76.5	34	463
	2020.06-	7DCT	F	L/R	Cabriolet FWD DMSB		2020750L	Drive Shaft		42		76.5	34	463
2.0 (120 kw)	2009.05-2014.06	CVT/6MT	F	L/R	Cabriolet FWD CAHB/CGLD		2032730L	Drive Shaft		42		76.5	34	460
	2019.04-	7AT	F	L/R	Cabriolet FWD DEZE/DTNA		2022560L	Drive Shaft		42		76.5	34	464
2.0 (125 kw)	2009.05-2012.03	6MT	F	L/R	Cabriolet FWD CAHA	Date to:2011.10	2032730L	Drive Shaft		42		76.5	34	460
2.0 (130 kw)	2011.10-2017.01	CVT/6MT	F	L/R	Cabriolet FWD CGLC	Date from:2011.11	2032730L	Drive Shaft		42		76.5	34	460
2.0 (132 kw)	2009.03-2012.03	CVT	F	L/R	Cabriolet FWD CAEA/CDNB	Date to:2011.10	2032730L	Drive Shaft		42		76.5	34	460
2.0 (140 kw)	2013.09-2017.01	CVT/6MT	F	L/R	Cabriolet FWD CNHA		2032730L	Drive Shaft		42		76.5	34	460
	2016.11-	7AT	F	L/R	Cabriolet FWD DETA		2022560L	Drive Shaft		42		76.5	34	464
	2017.03-2019.12	6MT/7DCT	F	L/R	Cabriolet FWD CVKB		2020750L	Drive Shaft		42		76.5	34	463
	2017.05-	6MT/7DCT	F	L/R	Cabriolet FWD DEMA/DKYA/DLVA	Date From:2020.07 For Engine:DEMA/DKYA For Engine:DLVA	2020750L	Drive Shaft		42		76.5	34	463
2.0 (155 kw)	2009.03-2014.06	CVT/6MT	F	L/R	Cabriolet FWD CAEB/CDNC	Date to:2011.10	2032730L	Drive Shaft		42		76.5	34	460
2.0 (180 kw)	2018.07-2019.12	7AT	F	L/R	Cabriolet FWD DKNA		2022560L	Drive Shaft		42		76.5	34	464
2.0 (185 kw)	2017.05-2019.12	7AT	F	L/R	Cabriolet FWD DDWA		2022560L	Drive Shaft		42		76.5	34	464
2.7 (120 kw)	2009.05-2012.03	CVT	F	L/R	Cabriolet FWD CGKB	Date from:2011.11	2032730L	Drive Shaft		42		76.5	34	460
2.7 (140 kw)	2009.03-2012.03	CVT/6MT	F	L/R	Cabriolet FWD CGKA	Date from:2011.11	2032730L	Drive Shaft		42		76.5	34	460
3.0 (150 kw)	2011.09-2017.01	CVT	F	L/R	Cabriolet FWD CLAB	Date from:2011.11	2032730L	Drive Shaft		42		76.5	34	460
3.2 (195 kw)	2009.03-2012.03	CVT	F	L/R	Cabriolet FWD CALA	Date to:2011.10	2032730L	Drive Shaft		42		76.5	34	460
A5 Cabrio Quattro														
2.0 (130 kw)	2012.01-2015.05	6MT	F	L/R	Cabriolet 4WD CGLC		2033710L	Drive Shaft		42		76.5	34	464
2.0 (140 kw)	2013.09-2017.01	7AT/6MT	F	L/R	Cabriolet 4WD CNHA		2033710L	Drive Shaft		42		76.5	34	464
	2017.03-	7AT	F	L/R	Cabriolet 4WD DETA	For PR code:GH1	2020740L	Drive Shaft		42		76.5	34	464
	2017.03-	7DCT	F	L/R	Cabriolet 4WD DETA	For PR code:GH4,For vehicles with AWD & variable torque dis	2020750L	Drive Shaft		42		76.5	34	463
	2017.03-	7DCT	R	L/R	Cabriolet 4WD DETA	For PR code:GH1	2023630L	Drive Shaft		38			34	624
2.0 (150 kw)	2020.06-	7DCT	F	L/R	Cabriolet 4WD DMSA	For PR code:GH4,For vehicles with AWD & variable torque dis	2020750L	Drive Shaft		42		76.5	34	463
	2020.06-	7DCT	R	L/R	Cabriolet 4WD DMSA	For PR code:GH1	2023630L	Drive Shaft		38			34	624
	2020.09-	7DCT	F	L/R	Cabriolet 4WD DTPA	For PR code:GH4,For vehicles with AWD & variable torque dis	2020750L	Drive Shaft		42		76.5	34	463
	2020.09-	7DCT	R	L/R	Cabriolet 4WD DTPA	For PR code:GH1	2023630L	Drive Shaft		38			34	624
2.0 (155 kw)	2009.03-2017.01	6AT/7AT	F	L/R	Cabriolet 4WD CAEB/CDNC/CPMA	Date From:2011.08,Chassis no. from:8FC000001	2033710L	Drive Shaft		42		76.5	34	464
2.0 (165 kw)	2013.05-2016.05	7AT	F	L/R	Cabriolet 4WD CNCD		2033710L	Drive Shaft		42		76.5	34	464
2.0 (169 kw)	2015.08-2017.01	7AT	F	L/R	Cabriolet 4WD CNCE		2033710L	Drive Shaft		42		76.5	34	464
2.0 (180 kw)	2018.07-	7AT	F	L/R	Cabriolet 4WD DKNA	For PR code:GH1	2020740L	Drive Shaft		42		76.5	34	464
	2018.07-	7DCT	F	L/R	Cabriolet 4WD DKNA	For PR code:GH4,For vehicles with AWD & variable torque dis	2020750L	Drive Shaft		42		76.5	34	463
	2018.07-	7DCT	R	L/R	Cabriolet 4WD DKNA	For PR code:GH1	2023630L	Drive Shaft		38			34	624
	2016.11-	7AT	F	L/R	Cabriolet 4WD CYMC/CYRB	For PR code:GH1	2020740L	Drive Shaft		42		76.5	34	464
2.0 (185 kw)	2016.11-	7DCT	F	L/R	Cabriolet 4WD CYMC/CYRB	For PR code:GH4,For vehicles with AWD & variable torque dis	2020750L	Drive Shaft		42		76.5	34	463
	2016.11-	7DCT	R	L/R	Cabriolet 4WD CYMC/CYRB	For PR code:GH1	2023630L	Drive Shaft		38			34	624
	2017.05-2019.12	7AT	F	L/R	Cabriolet 4WD DDWA/DLHB	For PR code:GH1	2020740L	Drive Shaft		42		76.5	34	464
	2017.05-2019.12	7DCT	F	L/R	Cabriolet 4WD DDWA/DLHB	For PR code:GH4,For vehicles with AWD & variable torque dis	2020750L	Drive Shaft		42		76.5	34	463
	2017.05-2019.12	7DCT	R	L/R	Cabriolet 4WD DDWA/DLHB	For PR code:GH1	2023630L	Drive Shaft		38			34	624
2.0 (195 kw)	2020.06-	7DCT	F	L/R	Cabriolet 4WD DMTA	For PR code:GH4,For vehicles with AWD & variable torque dis	2020750L	Drive Shaft		42		76.5	34	463
	2020.06-	7DCT	R	L/R	Cabriolet 4WD DMTA	For PR code:GH1	2023630L	Drive Shaft		38			34	624
3.0 (160 kw)	2016.12-2018.08	7DCT	F	L/R	Cabriolet 4WD CSWB		2020750L	Drive Shaft		42		76.5	34	463
3.0 (176 kw)	2009.03-2012.03	7DCT	F	L/R	Cabriolet 4WD CCWA	Date to:2011.10	2032730L	Drive Shaft		42		76.5	34	460
3.0 (210 kw)	2016.11-	8AT	F	L/R	Cabriolet 4WD DCPC		2020750L	Drive Shaft		42		76.5	34	463
A5 Quattro														
2.0 (130 kw)	2011.12-2017.01	7AT/6MT	F	L/R	Coupe 4WD CGLC		2033710L	Drive Shaft		42		76.5	34	464
2.0 (140 kw)	2013.09-2017.01	7AT/6MT	F	L/R	Coupe 4WD CNHA		2033710L	Drive Shaft		42		76.5	34	464
	2016.08-	6MT/7DCT	F	L/R	Coupe 4WD DESA/DETA	For PR code:GH4,For vehicles with AWD & variable torque dis	2020750L	Drive Shaft		42		76.5	34	463
	2016.08-	7AT/6MT	F	L/R	Coupe 4WD DESA/DETA	For PR code:GH1	2020740L	Drive Shaft		42		76.5	34	464
	2016.08-	6MT/7DCT	R	L/R	Coupe 4WD DESA/DETA	For PR code:GH1	2023630L	Drive Shaft		38			34	624
2.0 (150 kw)	2020.07-	7DCT	F	L/R	Coupe 4WD DMSA	For PR code:GH4,For vehicles with AWD & variable torque dis	2020750L	Drive Shaft		42		76.5	34	463
	2020.07-	7DCT	R	L/R	Coupe 4WD DMSA	For PR code:GH1	2023630L	Drive Shaft		38			34	624
	2020.09-	7DCT	F	L/R	Coupe 4WD DTPA	For PR code:GH4,For vehicles with AWD & variable torque dis	2020750L	Drive Shaft		42		76.5	34	463
	2020.09-	7DCT	R	L/R	Coupe 4WD DTPA	For PR code:GH1	2023630L	Drive Shaft		38			34	624
2.0 (155 kw)	2008.06-2017.01	6AT/7AT/8AT/6MT	F	L/R	Coupe 4WD CAEB/CDNC/CPMA	Chassis no. from:8T-C-000001	2033710L	Drive Shaft		42		76.5	34	464
2.0 (162 kw)	2013.05-2017.01	6MT	F	L/R	Coupe 4WD CAED		2033710L	Drive Shaft		42		76.5	34	464
2.0 (165 kw)	2013.05-2016.05	7AT/6MT	F	L/R	Coupe 4WD CNCD		2033710L	Drive Shaft		42		76.5	34	464
2.0 (169 kw)	2015.08-2017.01	7AT/6MT	F	L/R	Coupe 4WD CNCE		2033710L	Drive Shaft		42		76.5	34	464
2.0 (180 kw)	2018.07-	7AT	F	L/R	Coupe 4WD DKNA	For PR code:GH1	2020740L	Drive Shaft		42		76.5	34	464
	2018.07-	7DCT	F	L/R	Coupe 4WD DKNA	For PR code:GH4,For vehicles with AWD & variable torque dis	2020750L	Drive Shaft		42		76.5	34	463
	2018.07-	7DCT	R	L/R	Coupe 4WD DKNA	For PR code:GH1	2023630L	Drive Shaft		38			34	624
2.0 (183 kw)	2016.06-2020.02	7AT	F	L/R	Coupe 4WD CYRC	For PR code:GH1	2020740L	Drive Shaft		42		76.5	34	464





		TRANSM.	F/R	L/R	BODY STYLE & DRIVE TYPE & ENGINE	REMARKS	GSP Ref.		ABS	Technical Specifications				
										A	B	C	H	L
AUDI														
A5 Quattro														
2.0 (183 kw)	2016.06-2020.02	7DCT	F	L/R	Coupe 4WD CYRC	For PR code:GH4.For vehicles with AWD & variable torque dis.	2020750L	Drive Shaft		42		76.5	34	463
	2016.06-2020.02	7DCT	R	L/R	Coupe 4WD CYRC	For PR code:GH1	2023630L	Drive Shaft		38			34	624
2.0 (185 kw)	2016.06-	6MT/7DCT	F	L/R	Coupe 4WD CYMC/CYRB	For PR code:GH4.For vehicles with AWD & variable torque dis.	2020750L	Drive Shaft		42		76.5	34	463
	2016.06-	7AT/6MT	F	L/R	Coupe 4WD CYMC/CYRB	For PR code:GH1	2020740L	Drive Shaft		42		76.5	34	464
	2016.06-	6MT/7DCT	R	L/R	Coupe 4WD CYMC/CYRB	For PR code:GH1	2023630L	Drive Shaft		38			34	624
	2017.05-2020.02	6MT/7DCT	F	L/R	Coupe 4WD DDWA/DLHB	For PR code:GH4.For vehicles with AWD & variable torque dis.	2020750L	Drive Shaft		42		76.5	34	463
	2017.05-2020.02	7AT/6MT	F	L/R	Coupe 4WD DDWA/DLHB	For PR code:GH1	2020740L	Drive Shaft		42		76.5	34	464
	2017.05-2020.02	6MT/7DCT	R	L/R	Coupe 4WD DDWA/DLHB	For PR code:GH1	2023630L	Drive Shaft		38			34	624
2.0 (195 kw)	2019.10-	7DCT	F	L/R	Coupe 4WD DMTA/DPAA	For PR code:GH4.For vehicles with AWD & variable torque dis.	2020750L	Drive Shaft		42		76.5	34	463
	2019.10-	7DCT	R	L/R	Coupe 4WD DMTA/DPAA	For PR code:GH1	2023630L	Drive Shaft		38			34	624
3.0 (155 kw)	2008.03-2010.05	6AT/7DCT	F	L/R	Coupe 4WD CCWB		2032730L	Drive Shaft		42		76.5	34	460
3.0 (160 kw)	2016.07-2018.08	7DCT	F	L/R	Coupe 4WD CSWB		2020750L	Drive Shaft		42		76.5	34	463
3.0 (170 kw)	2018.07-	8AT	F	L/R	Coupe 4WD DCPE		2020750L	Drive Shaft		42		76.5	34	463
3.0 (176 kw)	2007.06-2012.03	6AT/7DCT/6MT	F	L/R	Coupe 4WD CAPA/CCWA	Chassis no. 88T_8_01000>Date to 2011.10.Chassis no. from 8T_8_01001	2032730L	Drive Shaft		42		76.5	34	460
3.0 (200 kw)	2017.02-2017.12	8AT	F	L/R	Coupe 4WD CRTC		2020750L	Drive Shaft		42		76.5	34	463
3.0 (210 kw)	2017.01-	8AT	F	L/R	Coupe 4WD DCPC		2020750L	Drive Shaft		42		76.5	34	463
	2020.08-	8AT	F	L/R	Coupe 4WD DMGA		2020750L	Drive Shaft		42		76.5	34	463
A5 Sportback														
1.4 (110 kw)	2017.01-2020.02	7DCT	F	L/R	Hatchback FWD CVNA		2020750L	Drive Shaft		42		76.5	34	463
1.8 (118 kw)	2009.11-2011.09	CVT/6MT	F	L/R	Hatchback FWD CDHB		2032730L	Drive Shaft		42		76.5	34	460
2.0 (100 kw)	2009.09-2017.01	CVT/6MT	F	L/R	Hatchback FWD CAGB/CJCB/CSUB	Date to:2011.10	2032730L	Drive Shaft		42		76.5	34	460
	2017.05-2018.08	6MT/7AT	F	L/R	Hatchback FWD DEUB		2022560L	Drive Shaft		42		76.5	34	464
	2019.10-	7AT	F	L/R	Hatchback FWD DEZB		2022560L	Drive Shaft		42		76.5	34	464
2.0 (105 kw)	2009.09-2013.05	CVT/6MT	F	L/R	Hatchback FWD CAGA/CJCA/CMEA/CMFA	Date to:2011.10	2032730L	Drive Shaft		42		76.5	34	460
2.0 (110 kw)	2017.01-2020.02	6MT/7DCT	F	L/R	Hatchback FWD CZHA/DEUA		2020750L	Drive Shaft		42		76.5	34	463
	2018.08-	6MT/7DCT	F	L/R	Hatchback FWD DLVB/DMSB	For Enginecode:DMSB/DLVB	2020750L	Drive Shaft		42		76.5	34	463
2.0 (120 kw)	2009.09-2017.01	CVT/6MT	F	L/R	Hatchback FWD CAHB/CGLD/CNHC	Date to:2011.10	2032730L	Drive Shaft		42		76.5	34	460
	2019.03-	7AT	F	L/R	Hatchback FWD DEZE/DTNA		2022560L	Drive Shaft		42		76.5	34	464
2.0 (125 kw)	2009.09-2012.02	6MT	F	L/R	Hatchback FWD CAHA	Date to:2011.10	2032730L	Drive Shaft		42		76.5	34	460
	2017.02-2020.08	6MT/7DCT	F	L/R	Hatchback FWD CVLA		2020750L	Drive Shaft		42		76.5	34	463
2.0 (130 kw)	2011.08-2017.01	CVT/6MT	F	L/R	Hatchback FWD CGLC		2032730L	Drive Shaft		42		76.5	34	460
2.0 (132 kw)	2009.09-2014.06	CVT/6MT	F	L/R	Hatchback FWD CDNB	Date to:2011.10	2032730L	Drive Shaft		42		76.5	34	460
2.0 (140 kw)	2013.09-2017.01	CVT/6MT	F	L/R	Hatchback FWD CNHA		2032730L	Drive Shaft		42		76.5	34	460
	2016.09-	6MT/7AT	F	L/R	Hatchback FWD DESA/DETA		2022560L	Drive Shaft		42		76.5	34	464
	2017.01-2020.02	6MT/7DCT	F	L/R	Hatchback FWD CVKB		2020750L	Drive Shaft		42		76.5	34	463
	2017.05-	6MT/7DCT	F	L/R	Hatchback FWD DEMA/DKYA/DLVA	For Enginecode:DEMA/DKYA/DLVA	2020750L	Drive Shaft		42		76.5	34	463
2.0 (150 kw)	2020.06-	7DCT	F	L/R	Hatchback FWD DMSA		2020750L	Drive Shaft		42		76.5	34	463
	2020.09-	7AT	F	L/R	Hatchback FWD DTPA		2022560L	Drive Shaft		42		76.5	34	464
2.0 (155 kw)	2009.09-2013.11	CVT/6MT	F	L/R	Hatchback FWD CDNC	Date to:2011.10	2032730L	Drive Shaft		42		76.5	34	460
2.0 (180 kw)	2018.08-2020.02	7AT	F	L/R	Hatchback FWD DKNA		2022560L	Drive Shaft		42		76.5	34	464
2.0 (185 kw)	2017.05-2020.02	7AT	F	L/R	Hatchback FWD DDWA		2022560L	Drive Shaft		42		76.5	34	464
2.7 (120 kw)	2009.09-2012.03	CVT	F	L/R	Hatchback FWD CGKB	Date from:2011.11	2032730L	Drive Shaft		42		76.5	34	460
2.7 (140 kw)	2007.07-2012.02	CVT/6MT	F	L/R	Hatchback FWD CAMA/CGKA	Date from:2011.11	2032730L	Drive Shaft		42		76.5	34	460
3.0 (150 kw)	2011.10-2017.01	CVT/6MT	F	L/R	Hatchback FWD CLAB		2032730L	Drive Shaft		42		76.5	34	460
A5 Sportback Quattro														
2.0 (110 kw)	2017.05-2020.02	6MT	F	L/R	Hatchback 4WD CZHA/DEUA	For PR code:GH1	2020740L	Drive Shaft		42		76.5	34	464
	2017.05-2020.02	6MT	F	L/R	Hatchback 4WD CZHA/DEUA	For PR code:GH4.For vehicles with AWD & variable torque dis.	2020750L	Drive Shaft		42		76.5	34	463
	2017.05-2020.02	6MT	R	L/R	Hatchback 4WD CZHA/DEUA	For PR code:GH1	2023630L	Drive Shaft		38			34	624
2.0 (130 kw)	2011.12-2017.01	7AT/6MT	F	L/R	Hatchback 4WD CGLC		2033710L	Drive Shaft		42		76.5	34	464
2.0 (140 kw)	2013.09-2017.01	7AT/6MT	F	L/R	Hatchback 4WD CNHA		2033710L	Drive Shaft		42		76.5	34	464
	2016.08-	6MT/7DCT	F	L/R	Hatchback 4WD DESA/DETA	For PR code:GH4.For vehicles with AWD & variable torque dis.	2020750L	Drive Shaft		42		76.5	34	463
	2016.08-	7AT/6MT	F	L/R	Hatchback 4WD DESA/DETA	For PR code:GH1	2020740L	Drive Shaft		42		76.5	34	464
	2016.08-	6MT/7DCT	R	L/R	Hatchback 4WD DESA/DETA	For PR code:GH1	2023630L	Drive Shaft		38			34	624
2.0 (150 kw)	2020.06-	7DCT	F	L/R	Hatchback 4WD DMSA	For PR code:GH4.For vehicles with AWD & variable torque dis.	2020750L	Drive Shaft		42		76.5	34	463
	2020.06-	7DCT	R	L/R	Hatchback 4WD DMSA	For PR code:GH1	2023630L	Drive Shaft		38			34	624
	2020.09-	7DCT	F	L/R	Hatchback 4WD DTPA	For PR code:GH4.For vehicles with AWD & variable torque dis.	2020750L	Drive Shaft		42		76.5	34	463
	2020.09-	7DCT	R	L/R	Hatchback 4WD DTPA	For PR code:GH1	2023630L	Drive Shaft		38			34	624
2.0 (155 kw)	2009.09-2017.01	7AT/6MT	F	L/R	Hatchback 4WD CDNC	Date From:2011.08.Date To:2013.05.Chassis no. from 8T_C-000001	2033710L	Drive Shaft		42		76.5	34	464
2.0 (165 kw)	2013.05-2016.05	7AT/6MT	F	L/R	Hatchback 4WD CNCD		2033710L	Drive Shaft		42		76.5	34	464
2.0 (169 kw)	2015.08-2017.01	7AT/6MT	F	L/R	Hatchback 4WD CNCE		2033710L	Drive Shaft		42		76.5	34	464
2.0 (180 kw)	2019.02-	7AT	F	L/R	Hatchback 4WD DKNA	For PR code:GH1	2020740L	Drive Shaft		42		76.5	34	464
	2019.02-	7DCT	F	L/R	Hatchback 4WD DKNA	For PR code:GH4.For vehicles with AWD & variable torque dis.	2020750L	Drive Shaft		42		76.5	34	463
	2019.02-	7DCT	R	L/R	Hatchback 4WD DKNA	For PR code:GH1	2023630L	Drive Shaft		38			34	624
2.0 (183 kw)	2016.09-2020.02	7AT	F	L/R	Hatchback 4WD CYRC	For PR code:GH1	2020740L	Drive Shaft		42		76.5	34	464
	2016.09-2020.02	7DCT	F	L/R	Hatchback 4WD CYRC	For PR code:GH4.For vehicles with AWD & variable torque dis.	2020750L	Drive Shaft		42		76.5	34	463



	 YEAR	TRANSM.	F/R	L/R	BODY STYLE & DRIVE TYPE & ENGINE	REMARKS	GSP Ref.	 PRODUCT	 ABS	Technical Specifications				
										A	B	C	H	L
AUDI														
A5 Sportback Quattro														
2.0 (183 kw)	2016.09-2020.02	7DCT	R	L/R	Hatchback 4WD CYRC	For PR code:GH1	2023630L	Drive Shaft		38			34	624
2.0 (185 kw)	2016.09-	7AT/6MT	F	L/R	Hatchback 4WD CYMC/CYRB	For PR code:GH1	2020740L	Drive Shaft		42		76.5	34	464
	2016.09-	7DCT	F	L/R	Hatchback 4WD CYMC/CYRB	For PR code:GH1. For vehicles with AWD & variable torque dis.	2020750L	Drive Shaft		42		76.5	34	463
	2016.09-	7DCT	R	L/R	Hatchback 4WD CYMC/CYRB	For PR code:GH1	2023630L	Drive Shaft		38			34	624
	2017.05-2020.02	6MT/7DCT	F	L/R	Hatchback 4WD DDWA/DLHB	For PR code:GH1. For vehicles with AWD & variable torque dis.	2020750L	Drive Shaft		42		76.5	34	463
	2017.05-2020.02	7AT/6MT	F	L/R	Hatchback 4WD DDWA/DLHB	For PR code:GH1	2020740L	Drive Shaft		42		76.5	34	464
	2017.05-2020.02	6MT/7DCT	R	L/R	Hatchback 4WD DDWA/DLHB	For PR code:GH1	2023630L	Drive Shaft		38			34	624
2.0 (195 kw)	2019.10-	7DCT	F	L/R	Hatchback 4WD DMTA	For PR code:GH1. For vehicles with AWD & variable torque dis.	2020750L	Drive Shaft		42		76.5	34	463
	2019.10-	7DCT	R	L/R	Hatchback 4WD DMTA	For PR code:GH1	2023630L	Drive Shaft		38			34	624
3.0 (160 kw)	2016.09-2018.08	7DCT	F	L/R	Hatchback 4WD CSWB		2020750L	Drive Shaft		42		76.5	34	463
3.0 (170 kw)	2018.07-	8AT	F	L/R	Hatchback 4WD DCPE		2020750L	Drive Shaft		42		76.5	34	463
3.0 (176 kw)	2009.05-2012.02	7DCT/6MT	F	L/R	Hatchback 4WD CCWA	Date to:2011.10	2032730L	Drive Shaft		42		76.5	34	460
3.0 (200 kw)	2017.02-2017.12	8AT	F	L/R	Hatchback 4WD CRTC		2020750L	Drive Shaft		42		76.5	34	463
3.0 (210 kw)	2017.01-	8AT	F	L/R	Hatchback 4WD DCPC		2020750L	Drive Shaft		42		76.5	34	463
	2020.08-	8AT	F	L/R	Hatchback 4WD DMGA		2020750L	Drive Shaft		42		76.5	34	463
A6														
1.8 (140 kw)	2014.09-2018.09	7AT/6MT	F	L/R	Estate FWD CYGA		2015300L	Drive Shaft		42		76.5	34	496
	2014.09-2018.09	7AT/6MT	F	L/R	Saloon FWD CYGA		2015300L	Drive Shaft		42		76.5	34	496
2.0 (100 kw)	2012.01-2018.09	6MT	F	R	Estate FWD CGLE/CSUE/DDCA	for Model cod 4GC	2015300L	Drive Shaft		42		76.5	34	496
	2012.01-2018.09	7DCT	F	L/R	Estate FWD CGLE/CSUE/DDCA	for Model cod 4GC	2015300L	Drive Shaft		42		76.5	34	496
	2012.01-2018.09	6MT/7DCT	F	R	Saloon FWD CGLE/CSUE	for Model cod 4GC	2015300L	Drive Shaft		42		76.5	34	496
	2012.01-2018.09	6MT/7DCT	F	L/R	Saloon FWD CGLE/CSUE		2015300L	Drive Shaft		42		76.5	34	496
2.0 (110 kw)	2014.09-2018.09	6MT/7DCT	F	L/R	Estate FWD CSUD/DDCB		2015300L	Drive Shaft		42		76.5	34	496
	2014.09-2018.09	6MT/7DCT	F	L/R	Saloon FWD CSUD/DDCB		2015300L	Drive Shaft		42		76.5	34	496
2.0 (132 kw)	2011.05-2015.04	AT/CVT/6MT	F	L/R	Saloon FWD CDNB		2015300L	Drive Shaft		42		76.5	34	496
	2011.06-2015.04	AT/CVT/6MT	F	L/R	Estate FWD CDNB		2015300L	Drive Shaft		42		76.5	34	496
2.0 (140 kw)	2013.11-2018.09	6MT	F	L	Estate FWD CNHA/CZJA/DDDA		2033820L	Drive Shaft		42		76.5	34	495
	2013.11-2018.09	7DCT	F	L/R	Estate FWD CNHA/CZJA/DDDA		2033820L	Drive Shaft		42		76.5	34	495
	2013.11-2018.09	6MT	F	L	Saloon FWD CNHA/CZJA/DDDA		2033820L	Drive Shaft		42		76.5	34	495
	2013.11-2018.09	7DCT	F	L/R	Saloon FWD CNHA/CZJA/DDDA		2033820L	Drive Shaft		42		76.5	34	495
2.0 (155 kw)	2011.03-2015.04	CVT	F	L/R	Saloon FWD CAEB	Date From:2011.11	2015300L	Drive Shaft		42		76.5	34	496
	2011.03-2015.04	CVT	F	L/R	Saloon FWD CAEB	Date To:2011.10	2015300L	Drive Shaft		42		76.5	34	496
2.0 (162 kw)	2011.03-2015.12	CVT	F	L/R	Saloon FWD CAED	Date From:2011.11	2015300L	Drive Shaft		42		76.5	34	496
	2011.03-2015.12	CVT	F	L/R	Saloon FWD CAED	Date To:2011.10	2015300L	Drive Shaft		42		76.5	34	496
2.0 (195 kw)	2020.05-	7AT	F	R	Estate FWD DMTA	Date from:2020.07	2033820L	Drive Shaft		42		76.5	34	495
	2020.05-	7AT	F	L/R	Estate FWD DMTA	Date to:2020.06	2033820L	Drive Shaft		42		76.5	34	495
	2020.05-	7AT	F	R	Saloon FWD DMTA	Date from:2020.07	2033820L	Drive Shaft		42		76.5	34	495
	2020.05-	7AT	F	L/R	Saloon FWD DMTA	Date to:2020.06	2033820L	Drive Shaft		42		76.5	34	495
2.8 (150 kw)	2010.11-2015.04	AT/CVT/6MT	F	L/R	Saloon FWD CHVA		2015300L	Drive Shaft		42		76.5	34	496
	2011.05-2015.04	AT/CVT/6MT	F	L/R	Estate FWD CHVA		2015300L	Drive Shaft		42		76.5	34	496
3.0 (160 kw)	2014.09-2018.09	7AT	F	L/R	Estate FWD CTCC/CZVB		2033820L	Drive Shaft		42		76.5	34	495
A6 Allroad Quattro														
2.0 (150 kw)	2020.09-	7AT	F	R	Estate 4WD DTPA		2033820L	Drive Shaft		42		76.5	34	495
3.0 (140 kw)	2015.11-2018.09	7AT	F	L/R	Estate 4WD CZVF		2015300L	Drive Shaft		42		76.5	34	496
3.0 (150 kw)	2012.01-2014.12	7AT	F	L/R	Estate 4WD CLAA		2015300L	Drive Shaft		42		76.5	34	496
3.0 (155 kw)	2014.09-2018.09	7AT	F	L/R	Estate 4WD CRTF/CZVC		2015300L	Drive Shaft		42		76.5	34	496
3.0 (160 kw)	2014.09-2018.09	7AT	F	L/R	Estate 4WD CRTE/CZVA		2015300L	Drive Shaft		42		76.5	34	496
3.0 (180 kw)	2012.01-2016.06	7AT	F	L/R	Estate 4WD CDUD/CKVC		2015300L	Drive Shaft		42		76.5	34	496
3.0 (200 kw)	2014.09-2018.09	7AT	F	L/R	Estate 4WD CRTD		2015300L	Drive Shaft		42		76.5	34	496
3.0 (228 kw)	2012.01-2014.12	7AT	F	L/R	Estate 4WD CGWD		2015300L	Drive Shaft		42		76.5	34	496
3.0 (230 kw)	2012.01-2014.12	8AT	F	L/R	Estate 4WD CGQB		2015300L	Drive Shaft		42		76.5	34	496
3.0 (235 kw)	2012.01-2018.09		F	L/R	Estate 4WD CVUA		2015300L	Drive Shaft		42		76.5	34	496
3.0 (245 kw)	2014.09-2018.09		F	L/R	Estate 4WD CREC		2015300L	Drive Shaft		42		76.5	34	496
A6 Quattro														
2.0 (120 kw)	2020.10-	7AT	F	R	Estate 4WD DTPB		2033820L	Drive Shaft		42		76.5	34	495
	2020.11-	7AT	F	R	Saloon 4WD DTPB		2033820L	Drive Shaft		42		76.5	34	495
2.0 (140 kw)	2015.04-2018.09	7AT	F	L/R	Estate 4WD CNHA/DDDA		2033820L	Drive Shaft		42		76.5	34	495
	2015.04-2018.09	7AT	F	L/R	Saloon 4WD CNHA/DDDA		2033820L	Drive Shaft		42		76.5	34	495
2.0 (183 kw)	2015.05-2018.09	7AT	F	L/R	Estate 4WD CYPB		2015300L	Drive Shaft		42		76.5	34	496
	2015.05-2018.09	7AT	F	L/R	Saloon 4WD CYPB		2015300L	Drive Shaft		42		76.5	34	496
2.0 (185 kw)	2014.11-2018.09	7AT/8AT	F	L/R	Saloon 4WD CYNB/CYPA		2015300L	Drive Shaft		42		76.5	34	496
	2015.05-2018.09	7AT	F	L/R	Estate 4WD CYPA		2015300L	Drive Shaft		42		76.5	34	496
2.0 (195 kw)	2020.05-	7AT	F	R	Estate 4WD DMTA	Date from:2020.07	2033820L	Drive Shaft		42		76.5	34	495
	2020.05-	7AT	F	L/R	Estate 4WD DMTA	Date to:2020.06	2033820L	Drive Shaft		42		76.5	34	495
	2020.05-	7AT	F	R	Saloon 4WD DMTA	Date from:2020.07	2033820L	Drive Shaft		42		76.5	34	495



		TRANSM.	F/R	L/R	BODY STYLE & DRIVE TYPE & ENGINE	REMARKS	GSP Ref.		ABS	Technical Specifications				
										A	B	C	H	L
AUDI														
A6 Quattro														
2.0 (195 kw)	2020.05-	7AT	F	L/R	Saloon 4WD DMTA	Date to:2020.06	2033820L	Drive Shaft		42		76.5	34	495
2.8 (150 kw)	2010.11-2015.04	7AT	F	L/R	Saloon 4WD CHVA		2015300L	Drive Shaft		42		76.5	34	496
	2011.05-2015.04	7AT	F	L/R	Estate 4WD CHVA		2015300L	Drive Shaft		42		76.5	34	496
2.8 (162 kw)	2014.09-2018.09	7AT	F	L/R	Estate 4WD CVPA		2015300L	Drive Shaft		42		76.5	34	496
	2014.09-2018.09	7AT	F	L/R	Saloon 4WD CVPA		2015300L	Drive Shaft		42		76.5	34	496
3.0 (150 kw)	2011.02-2015.04	7AT	F	L/R	Saloon 4WD CLAA		2015300L	Drive Shaft		42		76.5	34	496
	2011.05-2015.04	7AT	F	L/R	Estate 4WD CLAA		2015300L	Drive Shaft		42		76.5	34	496
3.0 (155 kw)	2014.09-2018.09	7AT	F	L/R	Estate 4WD CRTF/CZVC		2015300L	Drive Shaft		42		76.5	34	496
	2014.09-2018.09	7AT	F	L/R	Saloon 4WD CRTF/CZVC		2015300L	Drive Shaft		42		76.5	34	496
3.0 (160 kw)	2014.09-2018.09	7AT	F	L/R	Estate 4WD CRTE/CZVA		2015300L	Drive Shaft		42		76.5	34	496
	2014.09-2018.09	7AT	F	L/R	Saloon 4WD CRTE/CZVA		2015300L	Drive Shaft		42		76.5	34	496
3.0 (180 kw)	2010.11-2015.04	7AT	F	L/R	Saloon 4WD CDUC/CDUD/CKVB/CKVC		2015300L	Drive Shaft		42		76.5	34	496
	2011.05-2015.04	7AT	F	L/R	Estate 4WD CDUC/CDUD/CKVB/CKVC		2015300L	Drive Shaft		42		76.5	34	496
3.0 (200 kw)	2014.09-2018.09	7AT	F	L/R	Estate 4WD CRTD		2015300L	Drive Shaft		42		76.5	34	496
	2014.09-2018.09	7AT	F	L/R	Saloon 4WD CRTD		2015300L	Drive Shaft		42		76.5	34	496
3.0 (220 kw)	2010.11-2012.05	7AT	F	L/R	Saloon 4WD CGWB		2015300L	Drive Shaft		42		76.5	34	496
	2011.05-2014.12	7AT	F	L/R	Estate 4WD CGWB		2015300L	Drive Shaft		42		76.5	34	496
3.0 (228 kw)	2011.03-2015.04	7AT/8AT	F	L/R	Saloon 4WD CGWD/CGXB/CTUA		2015300L	Drive Shaft		42		76.5	34	496
	2011.11-2015.04	7AT	F	L/R	Estate 4WD CGWD		2015300L	Drive Shaft		42		76.5	34	496
3.0 (230 kw)	2011.11-2015.04	8AT	F	L/R	Estate 4WD CGQB		2015300L	Drive Shaft		42		76.5	34	496
	2011.11-2015.04	8AT	F	L/R	Saloon 4WD CGQB		2015300L	Drive Shaft		42		76.5	34	496
3.0 (235 kw)	2014.09-2018.09	8AT	F	L/R	Estate 4WD CVUA		2015300L	Drive Shaft		42		76.5	34	496
	2014.09-2018.09	8AT	F	L/R	Saloon 4WD CVUA		2015300L	Drive Shaft		42		76.5	34	496
3.0 (240 kw)	2014.09-2018.09	8AT	F	L/R	Estate 4WD CVUB		2015300L	Drive Shaft		42		76.5	34	496
	2014.10-2018.09	8AT	F	L/R	Saloon 4WD CVUB		2015300L	Drive Shaft		42		76.5	34	496
3.0 (245 kw)	2014.09-2018.09	7AT	F	L/R	Estate 4WD CREC		2015300L	Drive Shaft		42		76.5	34	496
	2014.09-2018.09	7AT/8AT	F	L/R	Saloon 4WD CREC		2015300L	Drive Shaft		42		76.5	34	496
A7 Sportback														
1.8 (140 kw)	2015.04-2018.05	DCT	F	L/R	Hatchback FWD CYGA		2015300L	Drive Shaft		42		76.5	34	496
2.8 (150 kw)	2011.02-2015.03	CVT	F	L/R	Hatchback FWD CHVA	Date From:2011.11	2015300L	Drive Shaft		42		76.5	34	496
	2011.02-2015.03	CVT	F	L/R	Hatchback FWD CHVA	Date To:2011.10	2015300L	Drive Shaft		42		76.5	34	496
A7 Sportback Quattro														
2.0 (150 kw)	2018.09-	7AT	F	R	Hatchback 4WD DFBA	<small>Data from 2020.07 For PE code 9MFA in vehicles with MMD & variable torque dis.</small>	2033820L	Drive Shaft		42		76.5	34	495
2.0 (183 kw)	2015.05-2018.05	DCT	F	L/R	Hatchback 4WD CYPB		2015300L	Drive Shaft		42		76.5	34	496
2.0 (185 kw)	2015.05-2018.05	DCT	F	L/R	Hatchback 4WD CYNB/CYPA		2015300L	Drive Shaft		42		76.5	34	496
2.8 (150 kw)	2010.10-2015.03		F	L/R	Hatchback 4WD CHVA		2015300L	Drive Shaft		42		76.5	34	496
2.8 (162 kw)	2014.09-2018.05	AT	F	L/R	Hatchback 4WD CVPA		2015300L	Drive Shaft		42		76.5	34	496
3.0 (150 kw)	2010.12-2015.03	7AT	F	L/R	Hatchback 4WD CLAA		2015300L	Drive Shaft		42		76.5	34	496
3.0 (155 kw)	2014.07-2018.12	AT	F	L/R	Hatchback 4WD CRTF/CTCB/CZVC		2015300L	Drive Shaft		42		76.5	34	496
3.0 (160 kw)	2014.07-2018.05	AT	F	L/R	Hatchback 4WD CRTE/CZVA		2015300L	Drive Shaft		42		76.5	34	496
3.0 (176 kw)	2013.05-2015.03	8AT	F	L/R	Hatchback 4WD CPNB		2015300L	Drive Shaft		42		76.5	34	496
3.0 (180 kw)	2010.07-2016.06	7AT/8AT	F	L/R	Hatchback 4WD CDUC/CDUD/CKVB/CKVC		2015300L	Drive Shaft		42		76.5	34	496
3.0 (200 kw)	2014.05-2018.05	AT	F	L/R	Hatchback 4WD CRTD		2015300L	Drive Shaft		42		76.5	34	496
3.0 (220 kw)	2010.07-2012.05		F	L/R	Hatchback 4WD CGWB		2015300L	Drive Shaft		42		76.5	34	496
3.0 (228 kw)	2011.11-2015.03	7AT/8AT	F	L/R	Hatchback 4WD CGWD/CGXB/CTTA		2015300L	Drive Shaft		42		76.5	34	496
3.0 (230 kw)	2011.11-2015.03	8AT	F	L/R	Hatchback 4WD CGQB		2015300L	Drive Shaft		42		76.5	34	496
3.0 (235 kw)	2014.05-2018.05	AT	F	L/R	Hatchback 4WD CVUA		2015300L	Drive Shaft		42		76.5	34	496
3.0 (240 kw)	2014.09-2018.05	AT	F	L/R	Hatchback 4WD CVUB		2015300L	Drive Shaft		42		76.5	34	496
3.0 (245 kw)	2014.05-2018.05	AT	F	L/R	Hatchback 4WD CREC		2015300L	Drive Shaft		42		76.5	34	496
A8														
2.0 (155 kw)	2012.02-2015.11	8AT	F	L/R	Saloon FWD CHJA		2033820L	Drive Shaft		42		76.5	34	495
3.0 (150 kw)	2011.09-2013.09	8AT	F	L/R	Saloon FWD CLAB		2033820L	Drive Shaft		42		76.5	34	495
A8 Quattro														
2.0 (185 kw)	2016.09-2018.01	8AT	F	L/R	Saloon 4WD CYPB		2015300L	Drive Shaft		42		76.5	34	496
3.0 (155 kw)	2010.08-2018.01	8AT	F	L/R	Saloon 4WD CDTB/CTBB		2015300L	Drive Shaft		42		76.5	34	496
3.0 (184 kw)	2010.07-2018.01	8AT	F	L/R	Saloon 4WD CDTA/CDTC/CMHA		2015300L	Drive Shaft		42		76.5	34	496
3.0 (190 kw)	2013.09-2018.01	8AT	F	L/R	Saloon 4WD CTBA		2015300L	Drive Shaft		42		76.5	34	496
3.0 (193 kw)	2015.05-2018.01	8AT	F	L/R	Saloon 4WD CTBD		2015300L	Drive Shaft		42		76.5	34	496
3.0 (213 kw)	2010.07-2018.01	8AT	F	L/R	Saloon 4WD CGWA/CGXA/CREG		2015300L	Drive Shaft		42		76.5	34	496
3.0 (228 kw)	2011.11-2018.01	8AT	F	L/R	Saloon 4WD CGWD/CREA		2015300L	Drive Shaft		42		76.5	34	496
3.0 (245 kw)	2010.06-2014.04	8AT	F	L/R	Saloon 4WD CGXC/CMDA		2015300L	Drive Shaft		42		76.5	34	496
4.0 (309 kw)	2012.05-2013.12	8AT	F	L/R	Saloon 4WD CEUA		2015300L	Drive Shaft		42		76.5	34	496
4.0 (320 kw)	2013.09-2018.01	8AT	F	L/R	Saloon 4WD CTGA		2015300L	Drive Shaft		42		76.5	34	496
4.2 (273 kw)	2009.11-2012.06	8AT	F	L/R	Saloon 4WD CDRA		2015300L	Drive Shaft		42		76.5	34	496
6.3 (368 kw)	2011.01-2018.01	8AT	F	L/R	Saloon 4WD CEJA/CTNA		2015300L	Drive Shaft		42		76.5	34	496



	 YEAR	TRANSM.	F/R	L/R	BODY STYLE & DRIVE TYPE & ENGINE	REMARKS	GSP Ref.	 PRODUCT ABS	Technical Specifications				
									A	B	C	H	L
AUDI Q2													
1.4 (110 kw)	2016.06-2018.08	6MT/7DCT	F	L	SUV FWD CZEA		2611000L	Drive Shaft	36	59.5	40.5	514	
	2016.06-2018.08	7DCT	F	R	SUV FWD CZEA		2033130L	Drive Shaft	36	59.5	40.5	794	
1.5 (110 kw)	2018.07-	6MT	F	R	SUV FWD DADA/DPCA		2033130L	Drive Shaft	36	59.5	40.5	794	
	2018.07-	6MT/7DCT	F	L	SUV FWD DADA/DPCA		2611000L	Drive Shaft	36	59.5	40.5	514	
1.6 (85 kw)	2016.06-	6MT	F	R	SUV FWD DDYA/DGTE		2612830L	Drive Shaft	36	59.5	40	815	
	2016.06-	6MT/7DCT	F	L	SUV FWD DDYA/DGTE		2612820L	Drive Shaft	36	59.5	40	523	
	2016.06-	7DCT	F	R	SUV FWD DDYA/DGTE		2610960L	Drive Shaft	36	59.5	40	800	
2.0 (110 kw)	2016.09-	6MT	F	R	SUV FWD DFGA/DTTC		2033130L	Drive Shaft	36	59.5	40.5	794	
	2016.09-	7DCT	F	L	SUV FWD DFGA/DTTC		2012650L	Drive Shaft	36	37	59.5	40	558
	2016.09-	Semi-AT	F	L	SUV FWD DFGA/DTTC		2612850L	Drive Shaft	36	59.5	40	472	
	2016.09-	Semi-AT	F	R	SUV FWD DFGA/DTTC		2033540L	Drive Shaft	36	59.5	40	760	
Q3													
1.4 (110 kw)	2013.10-2018.10	6DCT	F	R	SUV FWD CHPB/CZDA/CZEA	For Engine Code:CHPB	2016530L	Drive Shaft	36	59.5	40.5	785	
	2013.10-2018.10	6MT	F	L	SUV FWD CHPB/CZDA/CZEA	For Engine Code:CHPB;Trans. code:MQ350	2032950L	Drive Shaft	36	59.5	40.5	486	
	2013.10-2018.10	6MT	F	L	SUV FWD CHPB/CZDA/CZEA	For Engine Code:CHPB;Trans. code:MQ500	2612960L	Drive Shaft	36	40	59.5	40.5	501
	2013.10-2018.10	6MT	F	R	SUV FWD CHPB/CZDA/CZEA	For Engine Code:CHPB;Trans. code:MQ350	2611470L	Drive Shaft	36	59.5	40.5	795	
1.5 (110 kw)	2018.08-	6MT	F	L	SUV FWD DADA/DPCA		2018960L	Drive Shaft	36	59.5	40	500	
2.0 (88 kw)	2015.03-2018.10	6MT	F	L	SUV FWD CUVD/DFTC	Trans. Code:MQ350,For PR code:0EN	2032950L	Drive Shaft	36	59.5	40.5	486	
	2015.03-2018.10	6MT	F	R	SUV FWD CUVD/DFTC	Trans. Code:MQ350,For PR code:0EN	2611470L	Drive Shaft	36	59.5	40.5	795	
	2015.03-2018.10	7DCT	F	L	SUV FWD CUVD/DFTC		2012650L	Drive Shaft	36	37	59.5	40	558
	2015.03-2018.10	MT	F	L	SUV FWD CUVD/DFTC	For PR code:0EU	2612960L	Drive Shaft	36	40	59.5	40.5	501
2.0 (100 kw)	2011.09-2018.10	6MT	F	L	SUV FWD CFFA/CUVB/DFTB		2032950L	Drive Shaft	36	59.5	40.5	486	
	2011.09-2018.10	6MT	F	L	SUV FWD CFFA/CUVB/DFTB	For Engine Code:CFFA;Date From:2013.08;For PR code:0EU;Trans. Code:MQ500	2612960L	Drive Shaft	36	40	59.5	40.5	501
	2011.09-2018.10	6MT	F	R	SUV FWD CFFA/CUVB/DFTB		2611470L	Drive Shaft	36	59.5	40.5	795	
	2011.09-2018.10	7DCT	F	L	SUV FWD CFFA/CUVB/DFTB		2012650L	Drive Shaft	36	37	59.5	40	558
2.0 (103 kw)	2011.09-2015.04	6MT	F	L	SUV FWD CFFB/CLJA	For PR code:0EU;Trans. Code:MQ500	2032950L	Drive Shaft	36	59.5	40.5	486	
	2011.09-2015.04	6MT	F	L	SUV FWD CFFB/CLJA	For Engine Code:CFFB;For PR code:0EU;Trans. Code:MQ500	2612960L	Drive Shaft	36	40	59.5	40.5	501
	2011.09-2015.04	6MT	F	R	SUV FWD CFFB/CLJA	For PR code:0EU;Trans. Code:MQ500	2611470L	Drive Shaft	36	59.5	40.5	795	
2.0 (110 kw)	2014.11-2018.10	6MT	F	L	SUV FWD CUVC/DBBA/DFTA	Trans. Code:MQ350,For PR code:0EN	2032950L	Drive Shaft	36	59.5	40.5	486	
	2014.11-2018.10	6MT	F	R	SUV FWD CUVC/DBBA/DFTA	Trans. Code:MQ350,For PR code:0EN	2611470L	Drive Shaft	36	59.5	40.5	795	
	2014.11-2018.10	7DCT	F	L	SUV FWD CUVC/DBBA/DFTA		2012650L	Drive Shaft	36	37	59.5	40	558
	2014.11-2018.10	MT	F	L	SUV FWD CUVC/DBBA/DFTA	For PR code:0EU	2612960L	Drive Shaft	36	40	59.5	40.5	501
	2018.09-	6MT	F	L	SUV FWD DFGA/DTSA/DTSB		2611000L	Drive Shaft	36	59.5	40.5	514	
	2018.09-	6MT	F	R	SUV FWD DFGA/DTSA/DTSB		2613410L	Drive Shaft	36	59.5	40.5	806	
	2018.09-	7DCT	F	L	SUV FWD DFGA/DTSA/DTSB		2023510L	Drive Shaft	36	37	59.5	40	570
	2018.09-	7DCT	F	R	SUV FWD DFGA/DTSA/DTSB		2036130L	Drive Shaft	36	37	59.5	40	921
2.0 (130 kw)	2013.05-2015.04	6MT	F	L	SUV FWD CFGC	Trans. Code:MQ350,For PR code:0EN	2032950L	Drive Shaft	36	59.5	40.5	486	
	2013.05-2015.04	6MT	F	L	SUV FWD CFGC	Trans. Code:MQ500,For PR code:0EU	2612960L	Drive Shaft	36	40	59.5	40.5	501
	2013.05-2015.04	6MT	F	R	SUV FWD CFGC	Trans. Code:MQ350,For PR code:0EN	2611470L	Drive Shaft	36	59.5	40.5	795	
2.0 (132 kw)	2015.05-2018.10	6MT	F	L	SUV FWD CULB		2032950L	Drive Shaft	36	59.5	40.5	486	
	2015.05-2018.10	6MT	F	R	SUV FWD CULB		2611470L	Drive Shaft	36	59.5	40.5	795	
2.0 (135 kw)	2015.05-2018.10	6MT	F	L	SUV FWD CUWA/DFUA	Trans. Code:MQ350,For PR code:0EN	2032950L	Drive Shaft	36	59.5	40.5	486	
	2015.05-2018.10	6MT	F	R	SUV FWD CUWA/DFUA	Trans. Code:MQ350,For PR code:0EN	2611470L	Drive Shaft	36	59.5	40.5	795	
	2015.05-2018.10	MT	F	L	SUV FWD CUWA/DFUA	For PR code:0EU	2612960L	Drive Shaft	36	40	59.5	40.5	501
Q3 Quattro													
2.0 (103 kw)	2012.01-2015.04	6MT	F	L	SUV 4WD CFFB		2612960L	Drive Shaft	36	40	59.5	40.5	501
	2012.01-2015.04	6MT	F	R	SUV 4WD CFFB		2032660L	Drive Shaft	36	59.5	40.5	601	
	2012.01-2015.04	7DCT	F	L	SUV 4WD CFFB		2012650L	Drive Shaft	36	37	59.5	40	558
	2012.01-2015.04	7DCT	F	R	SUV 4WD CFFB		2613470L	Drive Shaft	36	40	59.5	40	593
	2012.01-2015.04	MT	F	L	SUV 4WD CFFB		2032950L	Drive Shaft	36	59.5	40.5	486	
2.0 (110 kw)	2014.11-2018.10	6MT	F	L	SUV 4WD CUVC/DFTA	Trans. Code:MQ350,For PR code:0EN,Date From:2017.10	2032950L	Drive Shaft	36	59.5	40.5	486	
	2014.11-2018.10	6MT	F	L	SUV 4WD CUVC/DFTA	Trans. Code:MQ500,For PR code:0EU	2612960L	Drive Shaft	36	40	59.5	40.5	501
	2014.11-2018.10	6MT	F	R	SUV 4WD CUVC/DFTA	Trans. Code:MQ350,For PR code:0EN,Date To:2017.09	2032660L	Drive Shaft	36	59.5	40.5	601	
	2014.11-2018.10	7DCT	F	L	SUV 4WD CUVC/DFTA		2012650L	Drive Shaft	36	37	59.5	40	558
	2014.11-2018.10	7DCT	F	R	SUV 4WD CUVC/DFTA		2613470L	Drive Shaft	36	40	59.5	40	593
	2018.07-	6MT	F	L	SUV 4WD DFGA/DTSA/DTSB		2018960L	Drive Shaft	36	59.5	40	500	
	2018.07-	7DCT	F	L	SUV 4WD DFGA/DTSA/DTSB		2023510L	Drive Shaft	36	37	59.5	40	570
2.0 (120 kw)	2011.06-2015.04	7AT	F	L	SUV 4WD CFGD		2012650L	Drive Shaft	36	37	59.5	40	558
	2011.06-2015.04	7AT	F	R	SUV 4WD CFGD		2613470L	Drive Shaft	36	40	59.5	40	593
2.0 (125 kw)	2011.06-2015.04	6MT	F	L	SUV 4WD CCZC	For PR code:0EU;Trans. code:MQ500	2612960L	Drive Shaft	36	40	59.5	40.5	501
	2011.06-2015.04	6MT	F	R	SUV 4WD CCZC	Date To:2017.09;For PR code:0EN,Trans. code:MQ350	2032660L	Drive Shaft	36	59.5	40.5	601	
	2011.06-2015.04	6MT	F	R	SUV 4WD CCZC	For PR code:0EU;Trans. code:MQ500	2032690L	Drive Shaft	36	40	59.5	40	596
	2011.06-2015.04	7DCT	F	L	SUV 4WD CCZC		2012650L	Drive Shaft	36	37	59.5	40	558
	2011.06-2015.04	7DCT	F	R	SUV 4WD CCZC		2613470L	Drive Shaft	36	40	59.5	40	593
	2011.06-2015.04	MT	F	L	SUV 4WD CCZC		2032950L	Drive Shaft	36	59.5	40.5	486	



	 YEAR	TRANSM.	F/R	L/R	BODY STYLE & DRIVE TYPE & ENGINE	REMARKS	GSP Ref.	 PRODUCT ABS	Technical Specifications				
									A	B	C	H	L
AUDI													
Q3 Quattro													
2.0 (130 kw)	2011.06-2015.04	6MT	F	L	SUV 4WD CFGC/CLLB	For PR code:0EU,Trans. code:MQ500	261296OL	Drive Shaft	36	40	59.5	40.5	501
	2011.06-2015.04	6MT	F	R	SUV 4WD CFGC/CLLB	Date To:2017.09,For PR code:0EN,Trans. code:MQ350	203266OL	Drive Shaft	36		59.5	40.5	601
	2011.06-2015.04	7DCT	F	L	SUV 4WD CFGC/CLLB		201265OL	Drive Shaft	36	37	59.5	40	558
	2011.06-2015.04	7DCT	F	R	SUV 4WD CFGC/CLLB		261347OL	Drive Shaft	36	40	59.5	40	593
	2011.06-2015.04	MT	F	L	SUV 4WD CFGC/CLLB		203295OL	Drive Shaft	36		59.5	40.5	486
2.0 (132 kw)	2015.01-2018.12	6MT	F	L	SUV 4WD CULB		203295OL	Drive Shaft	36		59.5	40.5	486
	2015.01-2018.12	6MT	F	R	SUV 4WD CULB		203266OL	Drive Shaft	36		59.5	40.5	601
	2015.01-2018.12	7DCT	F	L	SUV 4WD CULB		201265OL	Drive Shaft	36	37	59.5	40	558
	2015.01-2018.12	7DCT	F	R	SUV 4WD CULB		261347OL	Drive Shaft	36	40	59.5	40	593
2.0 (135 kw)	2014.11-2018.10	6MT	F	L	SUV 4WD CUWA/CYLA/DFUA	Trans. Code:MQ350,For PR code:0EN,Date From:2017.10	203295OL	Drive Shaft	36		59.5	40.5	486
	2014.11-2018.10	6MT	F	L	SUV 4WD CUWA/CYLA/DFUA	Trans. Code:MQ500,For PR code:0EU	261296OL	Drive Shaft	36	40	59.5	40.5	501
	2014.11-2018.10	6MT	F	R	SUV 4WD CUWA/CYLA/DFUA	Trans. Code:MQ350,For PR code:0EN,Date To:2017.09	203266OL	Drive Shaft	36		59.5	40.5	601
	2014.11-2018.10	7DCT	F	L	SUV 4WD CUWA/CYLA/DFUA		201265OL	Drive Shaft	36	37	59.5	40	558
	2014.11-2018.10	7DCT	F	R	SUV 4WD CUWA/CYLA/DFUA		261347OL	Drive Shaft	36	40	59.5	40	593
2.0 (140 kw)	2018.09-	7AT	F	L	SUV 4WD DKTC/DNNA	Trans. code:DQ381	202351OL	Drive Shaft	36	37	59.5	40	570
	2018.10-	7AT	F	L	SUV 4WD DFHA		202351OL	Drive Shaft	36	37	59.5	40	570
2.0 (147 kw)	2014.04-2018.10	DCT	F	R	SUV 4WD CCTA	For PR code:TQ2/G02	261347OL	Drive Shaft	36	40	59.5	40	593
2.0 (155 kw)	2011.06-2015.04	7AT	F	L	SUV 4WD CPSPA		201265OL	Drive Shaft	36	37	59.5	40	558
	2011.06-2015.04	7AT	F	R	SUV 4WD CPSPA		261347OL	Drive Shaft	36	40	59.5	40	593
2.0 (162 kw)	2014.11-2018.10	7AT	F	L	SUV 4WD CULC		201265OL	Drive Shaft	36	37	59.5	40	558
	2014.11-2018.10	7AT	F	R	SUV 4WD CULC		261347OL	Drive Shaft	36	40	59.5	40	593
2.0 (169 kw)	2018.07-	7AT	F	L	SUV 4WD DKTA		202351OL	Drive Shaft	36	37	59.5	40	570
2.0 (180 kw)	2021.01-	7AT	F	L	SUV 4WD DNPA		202351OL	Drive Shaft	36	37	59.5	40	570
Q3 Sportback													
1.5 (110 kw)	2019.09-	6MT	F	L	SUV FWD DPCA		201896OL	Drive Shaft	36		59.5	40	500
2.0 (110 kw)	2019.11-	6MT	F	L	SUV FWD DFGA/DTSA/DTSB		261100OL	Drive Shaft	36		59.5	40.5	514
	2019.11-	6MT	F	R	SUV FWD DFGA/DTSA/DTSB		261341OL	Drive Shaft	36		59.5	40.5	806
	2019.11-	7DCT	F	L	SUV FWD DFGA/DTSA/DTSB		202351OL	Drive Shaft	36	37	59.5	40	570
	2019.11-	7DCT	F	R	SUV FWD DFGA/DTSA/DTSB		203613OL	Drive Shaft	36	37	59.5	40	921
Q3 Sportback Quattro													
2.0 (110 kw)	2019.09-	6MT	F	L	SUV 4WD DFGA/DTSA/DTSB		201896OL	Drive Shaft	36		59.5	40	500
2.0 (140 kw)	2019.11-	7AT	F	L	SUV 4WD DKTC/DNNA	Trans. code:DQ500	202351OL	Drive Shaft	36	37	59.5	40	570
2.0 (169 kw)	2019.06-	7AT	F	L	SUV 4WD DKTA		202351OL	Drive Shaft	36	37	59.5	40	570
2.0 (180 kw)	2021.01-	7AT	F	L	SUV 4WD DNPA		202351OL	Drive Shaft	36	37	59.5	40	570
Q5													
2.0 (100 kw)	2011.11-2017.05	MT	F	L	SUV FWD CJCB/CSUB	Date From:2013.01	203382OL	Drive Shaft	42		76.5	34	495
	2011.11-2017.05	MT	F	L/R	SUV FWD CJCB/CSUB	Date To:2012.12	203316OL	Drive Shaft	42		76.5	34	494
2.0 (105 kw)	2011.11-2013.05	6MT	F	L/R	SUV FWD CJCA		203316OL	Drive Shaft	42		76.5	34	494
	2011.11-2013.05		F	L/R	SUV FWD CJCA		203382OL	Drive Shaft	42		76.5	34	495
2.0 (110 kw)	2012.06-2017.05	MT	F	L/R	SUV FWD CJCD/CSUA		203382OL	Drive Shaft	42		76.5	34	495
Q5 Quattro													
2.0 (100 kw)	2009.08-2017.05	MT	F	L/R	SUV 4WD CAGB/CJCB/CSUB	Date From:2013.01	202077OL	Drive Shaft	42		76.5	34	495
	2009.08-2017.05	MT	F	L/R	SUV 4WD CAGB/CJCB/CSUB	Date To:2012.12	203316OL	Drive Shaft	42		76.5	34	494
2.0 (105 kw)	2009.08-2013.05	6MT	F	L/R	SUV 4WD CAGA/CJCA	For Engine Code:CJCA	202077OL	Drive Shaft	42		76.5	34	495
	2009.08-2013.05	6MT	F	L/R	SUV 4WD CAGA/CJCA	For Engine Code:CAGA	203316OL	Drive Shaft	42		76.5	34	494
2.0 (110 kw)	2012.11-2017.05	6MT	F	L/R	SUV 4WD CJCD/CSUA		202077OL	Drive Shaft	42		76.5	34	495
2.0 (120 kw)	2008.11-2017.05	AT	F	L/R	SUV 4WD CAHB/CGLA/CGLD/CNHC		201530OL	Drive Shaft	42		76.5	34	496
	2008.11-2017.05	MT	F	L/R	SUV 4WD CAHB/CGLA/CGLD/CNHC	Date From:2013.01	202077OL	Drive Shaft	42		76.5	34	495
	2008.11-2017.05	MT	F	L/R	SUV 4WD CAHB/CGLA/CGLD/CNHC	Date To:2012.12	203316OL	Drive Shaft	42		76.5	34	494
2.0 (125 kw)	2008.11-2012.09	6MT	F	L/R	SUV 4WD CAHA/CGLB/CMGA		203316OL	Drive Shaft	42		76.5	34	494
	2008.11-2012.09	7DCT	F	L/R	SUV 4WD CAHA/CGLB/CMGA		201530OL	Drive Shaft	42		76.5	34	496
2.0 (130 kw)	2012.06-2017.05	6MT	F	L/R	SUV 4WD CGLC/CMGB		202077OL	Drive Shaft	42		76.5	34	495
	2012.06-2017.05	7DCT	F	L/R	SUV 4WD CGLC/CMGB		201530OL	Drive Shaft	42		76.5	34	496
2.0 (132 kw)	2009.08-2017.05	6MT	F	L/R	SUV 4WD CDN/CNCB	For Engine Code:CNCB	202077OL	Drive Shaft	42		76.5	34	495
	2009.08-2017.05	MT	F	L/R	SUV 4WD CDN/CNCB	For Engine Code:CDNB	203316OL	Drive Shaft	42		76.5	34	494
2.0 (140 kw)	2014.04-2017.05	6MT	F	L/R	SUV 4WD CNHA	8 balls	202077OL	Drive Shaft	42		76.5	34	495
	2014.04-2017.05	7DCT	F	L/R	SUV 4WD CNHA	Inner teeth of wheel side:28	201530OL	Drive Shaft	42		76.5	34	496
2.0 (155 kw)	2008.11-2012.09	7AT/8AT/6MT	F	L/R	SUV 4WD CAEB/CDNC		203316OL	Drive Shaft	42		76.5	34	494
	2011.06-2016.06	8AT	F	L/R	SUV 4WD CHJA		201530OL	Drive Shaft	42		76.5	34	496
	2011.06-2016.06	8AT	F	L/R	SUV 4WD CHJA	Date From:2012.11,Date To:2013.02,For Engine Code:CHJA	201530OL	Drive Shaft	42		76.5	34	496
2.0 (162 kw)	2013.05-2017.05	AT	F	L/R	SUV 4WD CPMB		202077OL	Drive Shaft	42		76.5	34	495
2.0 (165 kw)	2012.06-2016.05	8AT/6MT	F	L/R	SUV 4WD CNCD		202077OL	Drive Shaft	42		76.5	34	495
2.0 (169 kw)	2015.08-2017.05	AT/MT	F	L/R	SUV 4WD CNCE		202077OL	Drive Shaft	42		76.5	34	495
3.0 (155 kw)	2008.11-2012.09	7AT	F	L/R	SUV 4WD CCWB		201530OL	Drive Shaft	42		76.5	34	496
3.0 (176 kw)	2008.11-2017.05	8AT/7DCT	F	L/R	SUV 4WD CCWA/CPNB		201530OL	Drive Shaft	42		76.5	34	496



	 YEAR	TRANSM.	F/R	L/R	BODY STYLE & DRIVE TYPE & ENGINE	REMARKS	GSP Ref.	 PRODUCT	 ABS	Technical Specifications				
										A	B	C	H	L
AUDI														
Q5 Quattro														
3.0 (180 kw)	2012.06-2017.05	7AT	F	L/R	SUV 4WD CDUD		2015300L	Drive Shaft		42		76.5	34	496
3.0 (184 kw)	2014.01-2017.05	AT	F	L/R	SUV 4WD CTBC		2015300L	Drive Shaft		42		76.5	34	496
3.0 (190 kw)	2013.11-2017.05	AT	F	L/R	SUV 4WD CTBA		2015300L	Drive Shaft		42		76.5	34	496
3.0 (200 kw)	2012.06-2017.12	8AT	F	L/R	SUV 4WD CTUC/CTVA		2015300L	Drive Shaft		42		76.5	34	496
3.2 (199 kw)	2008.11-2012.09	6AT/7AT	F	L/R	SUV 4WD CALB	Date To:2012.09	2015300L	Drive Shaft		42		76.5	34	496
Q7 Quattro														
2.0 (185 kw)	2015.08-2019.12	8AT	F	L/R	SUV 4WD CYRB		2015310L	Drive Shaft		42		76.5	34	502
3.0 (150 kw)	2010.05-2015.08	8AT	F	L/R	SUV 4WD CJGC/CJMA		2350850L	Drive Shaft		30		64.4	103.5	526
3.0 (155 kw)	2006.03-2010.05	6AT	F	L/R	SUV 4WD BUN/CASB		2350850L	Drive Shaft		30		64.4	103.5	526
	2015.08-2019.12	8AT	F	L/R	SUV 4WD CRTE/CZZA/CZZB		2015310L	Drive Shaft		42		76.5	34	502
3.0 (160 kw)	2015.08-2019.12	8AT	F	L/R	SUV 4WD CRTE/CZZA/CZZB		2015310L	Drive Shaft		42		76.5	34	502
3.0 (165 kw)	2009.06-2012.05	6AT/8AT	F	L/R	SUV 4WD CATA		2350850L	Drive Shaft		30		64.4	103.5	526
3.0 (170 kw)	2018.07-	8AT	F	L	SUV 4WD DHXC/DPXB		2015310L	Drive Shaft		42		76.5	34	502
	2018.07-2019.12	8AT	F	L	SUV Van 4WD DHXC		2015310L	Drive Shaft		42		76.5	34	502
3.0 (171 kw)	2006.03-2008.05	6AT	F	L/R	SUV 4WD BUG		2350850L	Drive Shaft		30		64.4	103.5	526
3.0 (176 kw)	2007.11-2015.08	6AT/8AT	F	L/R	SUV 4WD CASA/CCMA/CJGA/CNRB		2350850L	Drive Shaft		30		64.4	103.5	526
3.0 (180 kw)	2011.05-2015.08	8AT	F	L/R	SUV 4WD CJGD/CLZB/CRCA		2350850L	Drive Shaft		30		64.4	103.5	526
3.0 (183 kw)	2015.06-	8AT	F	L/R	SUV 4WD CVMD		2015310L	Drive Shaft		42		76.5	34	502
3.0 (190 kw)	2015.06-2019.12	8AT	F	L/R	SUV 4WD CUEA		2015310L	Drive Shaft		42		76.5	34	502
3.0 (200 kw)	2010.05-2015.08	8AT	F	L/R	SUV 4WD CJTC/CJWC		2350850L	Drive Shaft		30		64.4	103.5	526
	2015.01-2019.12	8AT	F	L/R	SUV 4WD CRTC		2015310L	Drive Shaft		42		76.5	34	502
3.0 (206 kw)	2011.05-2015.08	8AT	F	L/R	SUV 4WD CJWE/CTWB		2350850L	Drive Shaft		30		64.4	103.5	526
3.0 (210 kw)	2018.07-	8AT	F	L	SUV 4WD DHXA/DPXA		2015310L	Drive Shaft		42		76.5	34	502
	2018.07-2019.12	8AT	F	L	SUV Van 4WD DHXA		2015310L	Drive Shaft		42		76.5	34	502
3.0 (245 kw)	2010.05-2015.08	8AT	F	L/R	SUV 4WD CJTB/CJWB/CNAA/CTWA		2350850L	Drive Shaft		30		64.4	103.5	526
	2015.01-2019.12	8AT	F	L/R	SUV 4WD CREC		2015310L	Drive Shaft		42		76.5	34	502
3.0 (250 kw)	2019.07-	8AT	F	L/R	SUV 4WD DCBD		2015310L	Drive Shaft		42		76.5	34	502
3.6 (206 kw)	2006.08-2010.05	6AT/6MT	F	L/R	SUV 4WD BHK		2350850L	Drive Shaft		30		64.4	103.5	526
4.2 (240 kw)	2007.03-2009.06	6AT	R	L/R	SUV 4WD BTR		2350860L	Drive Shaft		30			103.5	724
4.2 (250 kw)	2009.06-2015.08	6AT/8AT	F	L/R	SUV 4WD CCFA/CCFC		2350850L	Drive Shaft		30		64.4	103.5	526
	2009.06-2015.08	6AT	R	L/R	SUV 4WD CCFA/CCFC		2350860L	Drive Shaft		30			103.5	724
4.2 (257 kw)	2006.03-2010.05	6AT	F	L/R	SUV 4WD BAR		2350850L	Drive Shaft		30		64.4	103.5	526
6.0 (368 kw)	2008.09-2014.05	6AT	R	L/R	SUV 4WD CCGA		2350860L	Drive Shaft		30			103.5	724
Q8 Quattro														
3.0 (170 kw)	2018.07-	8AT	F	L/R	SUV 4WD DHXC/DPXB		2015310L	Drive Shaft		42		76.5	34	502
3.0 (183 kw)	2018.02-	AT	F	L/R	SUV 4WD CVMD		2015310L	Drive Shaft		42		76.5	34	502
3.0 (210 kw)	2018.02-	8AT	F	L/R	SUV 4WD DHXA/DPXA		2015310L	Drive Shaft		42		76.5	34	502
3.0 (250 kw)	2018.02-	8AT	F	L/R	SUV 4WD DCBD		2015310L	Drive Shaft		42		76.5	34	502
RS3 Quattro														
2.5 (294 kw)	2017.04-2020.10	7AT	F	L	Saloon 4WD DAZA/DNWA		2012650L	Drive Shaft		36	37	59.5	40	558
	2017.04-2020.10	7AT	F	R	Saloon 4WD DAZA/DNWA		2613470L	Drive Shaft		36	40	59.5	40	593
RS3 Sportback Quattro														
2.5 (250 kw)	2011.01-2012.12	7AT	F	L	Hatchback 4WD CEPA		2012650L	Drive Shaft		36	37	59.5	40	558
	2011.01-2012.12	7AT	F	R	Hatchback 4WD CEPA		2613470L	Drive Shaft		36	40	59.5	40	593
2.5 (270 kw)	2015.02-2016.08	7AT	F	L	Hatchback 4WD CZGB		2012650L	Drive Shaft		36	37	59.5	40	558
	2015.02-2016.08	7AT	F	R	Hatchback 4WD CZGB		2613470L	Drive Shaft		36	40	59.5	40	593
2.5 (294 kw)	2017.04-2020.10	7AT	F	L	Hatchback 4WD DAZA/DNWA		2012650L	Drive Shaft		36	37	59.5	40	558
	2017.04-2020.10	7AT	F	R	Hatchback 4WD DAZA/DNWA		2613470L	Drive Shaft		36	40	59.5	40	593
RS4 Quattro														
2.9 (331 kw)	2017.09-2019.09	8AT	F	L/R	Estate 4WD DECA		2020750L	Drive Shaft		42		76.5	34	463
RS5 Quattro														
2.9 (331 kw)	2017.04-	8AT	F	L/R	Coupe 4WD DECA		2020750L	Drive Shaft		42		76.5	34	463
4.2 (331 kw)	2010.03-2017.01	7DCT	F	L/R	Coupe 4WD CFSA	Date to:2011.10	2032730L	Drive Shaft		42		76.5	34	460
RS5 Sportback Quattro														
2.9 (331 kw)	2018.06-	8AT	F	L/R	Hatchback 4WD DECA		2020750L	Drive Shaft		42		76.5	34	463
RS6 Quattro														
4.0 (412 kw)	2013.01-2018.09	8AT	F	L/R	Estate 4WD CRDB/CWUB		2015300L	Drive Shaft		42		76.5	34	496
4.0 (445 kw)	2013.01-2018.09	8AT	F	L/R	Estate 4WD CWUC		2015300L	Drive Shaft		42		76.5	34	496
RS7 Sportback Quattro														
4.0 (412 kw)	2013.01-2018.05	AT	F	L/R	Hatchback 4WD CRDB/CWUB		2015300L	Drive Shaft		42		76.5	34	496
4.0 (445 kw)	2013.05-2018.04	AT	F	L/R	Hatchback 4WD CWUC		2015300L	Drive Shaft		42		76.5	34	496
RSQ3 Quattro														
2.5 (228 kw)	2013.05-2018.10	7AT	F	L	SUV 4WD CTSA		2012650L	Drive Shaft		36	37	59.5	40	558
	2013.05-2018.10	7AT	F	R	SUV 4WD CTSA		2613470L	Drive Shaft		36	40	59.5	40	593
2.5 (250 kw)	2013.05-2018.10	7AT	F	L	SUV 4WD CZGA		2012650L	Drive Shaft		36	37	59.5	40	558



		TRANSM.	F/R	L/R	BODY STYLE & DRIVE TYPE & ENGINE	REMARKS	GSP Ref.		ABS	Technical Specifications				
										A	B	C	H	L
AUDI RSQ3 Quattro														
2.5 (250 kw)	2013.05-2018.10	7AT	F	R	SUV 4WD CZGA		2613470L	Drive Shaft		36	40	59.5	40	593
2.5 (270 kw)	2016.03-2018.10	7AT	F	L	SUV 4WD CZGB		2012650L	Drive Shaft		36	37	59.5	40	558
	2016.03-2018.10	7AT	F	R	SUV 4WD CZGB		2613470L	Drive Shaft		36	40	59.5	40	593
2.5 (294 kw)	2019.10-	7AT	F	L	SUV 4WD DAZA/DNWA		2023510L	Drive Shaft		36	37	59.5	40	570
RSQ3 Sportback Quattro														
2.5 (294 kw)	2019.10-	7AT	F	L	SUV 4WD DAZA/DNWA		2023510L	Drive Shaft		36	37	59.5	40	570
S3 Quattro														
2.0 (188 kw)	2007.02-2012.08	6AT/6MT	F	L	Hatchback 4WD BZC/CDLC		2032950L	Drive Shaft		36		59.5	40.5	486
	2007.02-2012.08	6AT/6MT	F	R	Hatchback 4WD BZC/CDLC		2032660L	Drive Shaft		36		59.5	40.5	601
	2007.02-2012.08	MT/Semi-AT	F	L	Hatchback 4WD BZC/CDLC		2033800L	Drive Shaft		36		59.5	40	487
2.0 (195 kw)	2006.11-2012.08	6AT/6MT	F	L	Hatchback 4WD BHZ/CDLA		2032950L	Drive Shaft		36		59.5	40.5	486
	2006.11-2012.08	6AT/6MT	F	R	Hatchback 4WD BHZ/CDLA		2032660L	Drive Shaft		36		59.5	40.5	601
	2006.11-2012.08	MT/Semi-AT	F	L	Hatchback 4WD BHZ/CDLA		2033800L	Drive Shaft		36		59.5	40	487
S3 Sportback Quattro														
2.0 (188 kw)	2008.07-2013.03	6AT/6MT	F	L	Hatchback 4WD CDLC		2032950L	Drive Shaft		36		59.5	40.5	486
	2008.07-2013.03	6AT/6MT	F	R	Hatchback 4WD CDLC		2032660L	Drive Shaft		36		59.5	40.5	601
	2008.07-2013.03	MT/Semi-AT	F	L	Hatchback 4WD CDLC		2033800L	Drive Shaft		36		59.5	40	487
2.0 (195 kw)	2008.07-2013.03	6AT/6MT	F	L	Hatchback 4WD CDLA		2032950L	Drive Shaft		36		59.5	40.5	486
	2008.07-2013.03	6AT/6MT	F	R	Hatchback 4WD CDLA		2032660L	Drive Shaft		36		59.5	40.5	601
	2008.07-2013.03	MT/Semi-AT	F	L	Hatchback 4WD CDLA		2033800L	Drive Shaft		36		59.5	40	487
S4 Quattro														
3.0 (245 kw)	2009.03-2015.12	7DCT/6MT	F	L/R	Estate 4WD CAKA/CGBA/CGWC/CGXC/CREC/CTDA/CTUB	Date to:2011.10	2032730L	Drive Shaft		42		76.5	34	460
	2009.03-2015.12	7DCT/6MT	F	L/R	Saloon 4WD CAKA/CGBA/CGWC/CGXC/CREC/CTDA/CTUB	Date to:2011.10	2032730L	Drive Shaft		42		76.5	34	460
3.0 (255 kw)	2018.12-	8AT	F	L/R	Estate 4WD DEWB		2020750L	Drive Shaft		42		76.5	34	463
	2018.12-	8AT	F	L/R	Saloon 4WD DEWB		2020750L	Drive Shaft		42		76.5	34	463
3.0 (260 kw)	2016.05-2019.10	8AT	F	L/R	Estate 4WD CWGD		2020750L	Drive Shaft		42		76.5	34	463
	2016.05-2019.11	8AT	F	L/R	Saloon 4WD CWGD		2020750L	Drive Shaft		42		76.5	34	463
S5 Cabrio Quattro														
3.0 (245 kw)	2009.05-2017.01	7DCT	F	L/R	Cabriolet 4WD CAKA/CGBA/CGWC/CGXC/CREC/CTDA/CTUB	Date to:2011.10	2032730L	Drive Shaft		42		76.5	34	460
3.0 (260 kw)	2016.11-	8AT	F	L/R	Cabriolet 4WD CWGD		2020750L	Drive Shaft		42		76.5	34	463
S5 Quattro														
3.0 (245 kw)	2011.09-2017.01	7DCT	F	L/R	Coupe 4WD CAKA/CGWC/CGXC/CREC/CTDA/CTUB	Date to:2011.10	2032730L	Drive Shaft		42		76.5	34	460
3.0 (251 kw)	2021.01-	8AT	F	L/R	Coupe 4WD DMKC		2020750L	Drive Shaft		42		76.5	34	463
3.0 (255 kw)	2018.12-	8AT	F	L/R	Coupe 4WD DEWB		2020750L	Drive Shaft		42		76.5	34	463
3.0 (260 kw)	2016.07-	8AT	F	L/R	Coupe 4WD CWGD		2020750L	Drive Shaft		42		76.5	34	463
4.2 (260 kw)	2007.06-2012.02	6AT/6MT	F	L/R	Coupe 4WD CAUA	Date to:2011.10	2032730L	Drive Shaft		42		76.5	34	460
S5 Sportback Quattro														
3.0 (245 kw)	2010.01-2017.01	7DCT	F	L/R	Hatchback 4WD CAKA/CGWC/CGXC/CREC/CTDA/CTUB	Date to:2011.10	2032730L	Drive Shaft		42		76.5	34	460
3.0 (251 kw)	2021.01-	8AT	F	L/R	Hatchback 4WD DMKC		2020750L	Drive Shaft		42		76.5	34	463
3.0 (255 kw)	2018.12-	8AT	F	L/R	Hatchback 4WD DEWB		2020750L	Drive Shaft		42		76.5	34	463
3.0 (260 kw)	2016.09-	8AT	F	L/R	Hatchback 4WD CWGD		2020750L	Drive Shaft		42		76.5	34	463
S6 Quattro														
3.0 (257 kw)	2019.03-	8AT	F	L/R	Estate 4WD DEWA		2033820L	Drive Shaft		42		76.5	34	495
	2019.03-	8AT	F	L/R	Saloon 4WD DEWA		2033820L	Drive Shaft		42		76.5	34	495
4.0 (309 kw)	2012.04-2015.04	7AT	F	L/R	Estate 4WD CEUC		2015300L	Drive Shaft		42		76.5	34	496
	2012.04-2015.04	7AT	F	L/R	Saloon 4WD CEUC		2015300L	Drive Shaft		42		76.5	34	496
4.0 (331 kw)	2014.10-2018.09	7AT	F	L/R	Estate 4WD CTGE		2015300L	Drive Shaft		42		76.5	34	496
	2014.10-2018.09	7AT	F	L/R	Saloon 4WD CTGE		2015300L	Drive Shaft		42		76.5	34	496
S7 Sportback Quattro														
4.0 (309 kw)	2012.02-2015.03	7AT	F	L/R	Hatchback 4WD CEUC		2015300L	Drive Shaft		42		76.5	34	496
4.0 (331 kw)	2014.07-2018.05	AT	F	L/R	Hatchback 4WD CTGE		2015300L	Drive Shaft		42		76.5	34	496
S8 Plus Quattro														
4.0 (445 kw)	2015.11-2018.01	8AT	F	L/R	Saloon 4WD DDTA		2015300L	Drive Shaft		42		76.5	34	496
S8 Quattro														
4.0 (382 kw)	2012.02-2018.01	8AT	F	L/R	Saloon 4WD CGTA/CTFA		2015300L	Drive Shaft		42		76.5	34	496
SQ5 Quattro														
3.0 (230 kw)	2012.12-2015.11	AT	F	L/R	SUV 4WD CGQB/CVUC		2015300L	Drive Shaft		42		76.5	34	496
3.0 (240 kw)	2015.04-2017.05	AT	F	L/R	SUV 4WD CVUB		2015300L	Drive Shaft		42		76.5	34	496
3.0 (250 kw)	2015.11-2017.05	AT	F	L/R	SUV 4WD DEHA		2015300L	Drive Shaft		42		76.5	34	496
3.0 (260 kw)	2013.05-2017.05	8AT	F	L/R	SUV 4WD CTUD/CTXA		2015300L	Drive Shaft		42		76.5	34	496
TT														
1.8 (118 kw)	2008.06-2014.06	7AT/6MT	F	L	Cabriolet FWD CDAA		2612810L	Drive Shaft		36		59.5	40.5	525
	2008.06-2014.06	7DCT	F	R	Cabriolet FWD CDAA		2613410L	Drive Shaft		36		59.5	40.5	806
	2008.06-2014.12	7AT/6MT	F	L	Coupe FWD CDAA		2612810L	Drive Shaft		36		59.5	40.5	525
	2008.06-2014.12	7DCT	F	R	Coupe FWD CDAA		2613410L	Drive Shaft		36		59.5	40.5	806



		TRANSM.	F/R	L/R	BODY STYLE & DRIVE TYPE & ENGINE	REMARKS	GSP Ref.		ABS	Technical Specifications				
										A	B	C	H	L
AUDI														
TT														
1.8 (132 kw)	2015.07-2018.08	7AT/6MT	F	L	Cabriolet FWD CJSA/CJSB		2612810L	Drive Shaft		36		59.5	40.5	525
	2015.07-2018.08	7DCT	F	R	Cabriolet FWD CJSA/CJSB		2613410L	Drive Shaft		36		59.5	40.5	806
	2015.07-2018.08	7AT/6MT	F	L	Coupe FWD CJSA/CJSB		2612810L	Drive Shaft		36		59.5	40.5	525
	2015.07-2018.08	7DCT	F	R	Coupe FWD CJSA/CJSB		2613410L	Drive Shaft		36		59.5	40.5	806
2.0 (135 kw)	2014.07-	6MT	F	R	Coupe FWD CUNA		2613410L	Drive Shaft		36		59.5	40.5	806
	2014.11-	6MT	F	R	Cabriolet FWD CUNA		2613410L	Drive Shaft		36		59.5	40.5	806
2.0 (147 kw)	2006.08-2010.06	6MT	F	R	Coupe FWD BWA		2613410L	Drive Shaft		36		59.5	40.5	806
	2007.03-2010.06	6MT	F	R	Cabriolet FWD BWA		2613410L	Drive Shaft		36		59.5	40.5	806
2.0 (169 kw)	2014.07-	6MT	F	R	Coupe FWD CHHC		2613410L	Drive Shaft		36		59.5	40.5	806
	2014.11-	6MT	F	R	Cabriolet FWD CHHC		2613410L	Drive Shaft		36		59.5	40.5	806
2.0 (180 kw)	2018.07-	6MT	F	R	Cabriolet FWD DKTB		2613410L	Drive Shaft		36		59.5	40.5	806
	2018.07-	6MT	F	R	Coupe FWD DKTB		2613410L	Drive Shaft		36		59.5	40.5	806
TT Quattro														
2.0 (125 kw)	2008.06-2014.06	6DCT	F	L	Cabriolet 4WD CBBB/CFGB		2033810L	Drive Shaft		36		59.5	40	485
	2008.06-2014.06	6DCT	F	L	Cabriolet 4WD CBBB/CFGB		2540130L	Drive Shaft		36		59.5	40.5	482
	2008.06-2014.06	6DCT	F	L	Coupe 4WD CBBB/CFGB		2033810L	Drive Shaft		36		59.5	40	485
	2008.06-2014.06	6DCT	F	L	Coupe 4WD CBBB/CFGB		2540130L	Drive Shaft		36		59.5	40.5	482
2.0 (135 kw)	2017.01-	6AT	F	L	Cabriolet 4WD CUNA		2033810L	Drive Shaft		36		59.5	40	485
	2017.01-	6AT	F	L	Coupe 4WD CUNA		2033810L	Drive Shaft		36		59.5	40	485
2.0 (155 kw)	2010.05-2014.06	6AT/6MT	F	R	Cabriolet 4WD CESA/CETA		2018890L	Drive Shaft		36		59.5	40	614
	2010.05-2014.06	6AT/6MT	F	R	Coupe 4WD CESA/CETA	Date To:2012.05	2018890L	Drive Shaft		36		59.5	40	614
2.0 (169 kw)	2014.07-	6AT	F	R	Coupe 4WD CHHC		2018890L	Drive Shaft		36		59.5	40	614
	2014.11-	6AT	F	R	Cabriolet 4WD CHHC		2018890L	Drive Shaft		36		59.5	40	614
2.0 (180 kw)	2018.07-	7AT	F	R	Cabriolet 4WD DKTB		2018890L	Drive Shaft		36		59.5	40	614
	2018.07-	7AT	F	R	Coupe 4WD DKTB		2018890L	Drive Shaft		36		59.5	40	614
2.0 (225 kw)	2018.08-	7AT	F	R	Cabriolet 4WD DNUF		2018890L	Drive Shaft		36		59.5	40	614
	2018.08-	7AT	F	R	Coupe 4WD DNUF		2018890L	Drive Shaft		36		59.5	40	614
TTRS Quattro														
2.5 (250 kw)	2009.07-2014.06	6MT	F	L	Cabriolet 4WD CEPA		2036840L	Drive Shaft		36	40	59.5	40	514
	2009.07-2014.06	7DCT	F	L	Cabriolet 4WD CEPA		2012650L	Drive Shaft		36	37	59.5	40	558
	2009.07-2014.06	7DCT	F	R	Cabriolet 4WD CEPA		2613470L	Drive Shaft		36	40	59.5	40	593
	2009.07-2014.06	6MT	F	L	Coupe 4WD CEPA		2036840L	Drive Shaft		36	40	59.5	40	514
	2009.07-2014.06	7DCT	F	L	Coupe 4WD CEPA		2012650L	Drive Shaft		36	37	59.5	40	558
	2009.07-2014.06	7DCT	F	R	Coupe 4WD CEPA		2613470L	Drive Shaft		36	40	59.5	40	593
2.5 (265 kw)	2011.05-2014.06	6MT	F	L	Cabriolet 4WD CEPB		2036840L	Drive Shaft		36	40	59.5	40	514
	2011.05-2014.06	7DCT	F	L	Cabriolet 4WD CEPB		2012650L	Drive Shaft		36	37	59.5	40	558
	2011.05-2014.06	7DCT	F	R	Cabriolet 4WD CEPB		2613470L	Drive Shaft		36	40	59.5	40	593
	2011.05-2014.06	6MT	F	L	Coupe 4WD CEPB		2036840L	Drive Shaft		36	40	59.5	40	514
	2011.05-2014.06	7DCT	F	L	Coupe 4WD CEPB		2012650L	Drive Shaft		36	37	59.5	40	558
	2011.05-2014.06	7DCT	F	R	Coupe 4WD CEPB		2613470L	Drive Shaft		36	40	59.5	40	593
2.5 (294 kw)	2016.05-	7AT	F	L	Cabriolet 4WD DAZA/DNWA		2012650L	Drive Shaft		36	37	59.5	40	558
	2016.05-	7AT	F	R	Cabriolet 4WD DAZA/DNWA		2613470L	Drive Shaft		36	40	59.5	40	593
	2016.05-	7AT	F	L	Coupe 4WD DAZA/DNWA		2012650L	Drive Shaft		36	37	59.5	40	558
	2016.05-	7AT	F	R	Coupe 4WD DAZA/DNWA		2613470L	Drive Shaft		36	40	59.5	40	593
TTS Quattro														
2.0 (195 kw)	2008.05-2014.06	6AT/6MT	F	R	Cabriolet 4WD CDLA/CDMA		2018890L	Drive Shaft		36		59.5	40	614
	2008.05-2014.06	6AT/6MT	F	R	Coupe 4WD CDLA/CDMA		2018890L	Drive Shaft		36		59.5	40	614
2.0 (200 kw)	2008.05-2014.06	6AT/6MT	F	R	Cabriolet 4WD CDLB		2018890L	Drive Shaft		36		59.5	40	614
	2008.05-2014.06	6AT/6MT	F	R	Coupe 4WD CDLB		2018890L	Drive Shaft		36		59.5	40	614
2.0 (210 kw)	2015.02-	6AT	F	R	Cabriolet 4WD CJXF		2018890L	Drive Shaft		36		59.5	40	614
	2015.02-	6AT	F	R	Coupe 4WD CJXF		2018890L	Drive Shaft		36		59.5	40	614
2.0 (215 kw)	2015.07-	6AT	F	R	Coupe 4WD CYFB		2018890L	Drive Shaft		36		59.5	40	614
2.0 (228 kw)	2014.11-	6AT/6MT	F	R	Cabriolet 4WD CJXG		2018890L	Drive Shaft		36		59.5	40	614
	2014.11-	6AT/6MT	F	R	Coupe 4WD CJXG		2018890L	Drive Shaft		36		59.5	40	614
BMW														
114d														
1.6 (70 kw)	2012.07-	MT	R	L	Hatchback RWD N47D16A		2050660L	Drive Shaft		28	27		71	743
	2012.07-	MT	R	R	Hatchback RWD N47D16A		2050670L	Drive Shaft		28	27		71	796
	2012.11-2015.06	MT	R	L	Hatchback RWD N47D16A		2050660L	Drive Shaft		28	27		71	743
	2012.11-2015.06	MT	R	R	Hatchback RWD N47D16A		2050670L	Drive Shaft		28	27		71	796
114i														
1.6 (75 kw)	2011.11-	6MT	R	L	Hatchback RWD N13B16A		2050660L	Drive Shaft		28	27		71	743
	2011.11-	6MT	R	R	Hatchback RWD N13B16A		2050670L	Drive Shaft		28	27		71	796
	2012.07-2015.02	6MT	R	L	Hatchback RWD N13B16A		2050660L	Drive Shaft		28	27		71	743
	2012.07-2015.02	6MT	R	R	Hatchback RWD N13B16A		2050670L	Drive Shaft		28	27		71	796



		TRANSM.	F/R	L/R	BODY STYLE & DRIVE TYPE & ENGINE	REMARKS	GSP Ref.		Technical Specifications				
									PRODUCT	ABS	A	B	C
BMW 116d													
1.5 (85 kw)	2015.03-	AT/MT	R	L	Hatchback RWD B37D15A		205066OL	Drive Shaft	28	27		71	743
	2015.03-	AT/MT	R	R	Hatchback RWD B37D15A		205067OL	Drive Shaft	28	27		71	796
	2015.03-2019.06	AT/MT	R	L	Hatchback RWD B37D15A		205066OL	Drive Shaft	28	27		71	743
	2015.03-2019.06	AT/MT	R	R	Hatchback RWD B37D15A		205067OL	Drive Shaft	28	27		71	796
1.6 (85 kw)	2012.02-2015.02	6MT	R	L	Hatchback RWD N47D16A		205066OL	Drive Shaft	28	27		71	743
	2012.02-2015.02	6MT	R	R	Hatchback RWD N47D16A		205067OL	Drive Shaft	28	27		71	796
	2012.03-2015.02	6MT	R	L	Hatchback RWD N47D16A		205066OL	Drive Shaft	28	27		71	743
	2012.03-2015.02	6MT	R	R	Hatchback RWD N47D16A		205067OL	Drive Shaft	28	27		71	796
2.0 (85 kw)	2011.06-2015.02	AT/MT	R	L	Hatchback RWD N47D20C		205066OL	Drive Shaft	28	27		71	743
	2011.06-2015.02	AT/MT	R	R	Hatchback RWD N47D20C		205067OL	Drive Shaft	28	27		71	796
	2011.07-2015.02	AT/MT	R	L	Hatchback RWD N47D20C		205066OL	Drive Shaft	28	27		71	743
	2011.07-2015.02	AT/MT	R	R	Hatchback RWD N47D20C		205067OL	Drive Shaft	28	27		71	796
116i													
1.5 (80 kw)	2015.03-	MT	R	L	Hatchback RWD B38B15A		205066OL	Drive Shaft	28	27		71	743
	2015.03-	MT	R	R	Hatchback RWD B38B15A		205067OL	Drive Shaft	28	27		71	796
	2015.03-2019.06	8AT/6MT	R	L	Hatchback RWD B38B15A		205066OL	Drive Shaft	28	27		71	743
	2015.03-2019.06	8AT/6MT	R	R	Hatchback RWD B38B15A		205067OL	Drive Shaft	28	27		71	796
	2020.11-	6MT	F	L	Hatchback FWD B38A15A		202631OL	Drive Shaft	31	34	56		563
	2020.11-	6MT	F	R	Hatchback FWD B38A15A		202632OL	Drive Shaft	31	34	56		920
1.6 (100 kw)	2011.07-2015.02	AT/MT	R	L	Hatchback RWD N13B16A		205066OL	Drive Shaft	28	27		71	743
	2011.07-2015.02	AT/MT	R	R	Hatchback RWD N13B16A		205067OL	Drive Shaft	28	27		71	796
	2011.12-2015.02	AT/MT	R	R	Hatchback RWD N13B16A		205067OL	Drive Shaft	28	27		71	796
	2011.12-2015.02	MT	R	L	Hatchback RWD N13B16A		205066OL	Drive Shaft	28	27		71	743
118d													
2.0 (100 kw)	2011.07-2019.06	AT/MT	R	L	Hatchback RWD B47D20A/N47D20C		205066OL	Drive Shaft	28	27		71	743
	2011.07-2019.06	AT/MT	R	R	Hatchback RWD B47D20A/N47D20C		205067OL	Drive Shaft	28	27		71	796
	2011.12-	AT/MT	R	L	Hatchback RWD B47D20A/N47D20C		205066OL	Drive Shaft	28	27		71	743
	2011.12-	AT/MT	R	R	Hatchback RWD B47D20A/N47D20C		205067OL	Drive Shaft	28	27		71	796
2.0 (105 kw)	2011.06-2015.02	8AT/6MT	R	L	Hatchback RWD N47D20C		205066OL	Drive Shaft	28	27		71	743
	2011.06-2015.02	8AT/6MT	R	R	Hatchback RWD N47D20C		205067OL	Drive Shaft	28	27		71	796
	2011.07-2015.02	AT/MT	R	L	Hatchback RWD N47D20C		205066OL	Drive Shaft	28	27		71	743
	2011.07-2015.02	AT/MT	R	R	Hatchback RWD N47D20C		205067OL	Drive Shaft	28	27		71	796
2.0 (110 kw)	2015.03-	AT/MT	R	L	Hatchback RWD B47D20A		205066OL	Drive Shaft	28	27		71	743
	2015.03-	AT/MT	R	R	Hatchback RWD B47D20A		205067OL	Drive Shaft	28	27		71	796
	2015.03-2019.06	AT/MT	R	L	Hatchback RWD B47D20A		205066OL	Drive Shaft	28	27		71	743
	2015.03-2019.06	AT/MT	R	R	Hatchback RWD B47D20A		205067OL	Drive Shaft	28	27		71	796
	2015.03-2019.06	6MT	R	L	Hatchback Van RWD B47D20A		205066OL	Drive Shaft	28	27		71	743
	2015.03-2019.06	6MT	R	R	Hatchback Van RWD B47D20A		205067OL	Drive Shaft	28	27		71	796
118d xDrive													
2.0 (105 kw)	2013.07-2015.02	MT	F	L	Hatchback 4WD N47D20C		202052OL	Drive Shaft	31	27	56.8		550
	2013.07-2015.02	MT	F	R	Hatchback 4WD N47D20C		202053OL	Drive Shaft	31	27	56.8		841
	2013.07-2015.02	MT	R	L	Hatchback 4WD N47D20C		205066OL	Drive Shaft	28	27		71	743
	2013.07-2015.02	MT	R	R	Hatchback 4WD N47D20C		205067OL	Drive Shaft	28	27		71	796
2.0 (110 kw)	2015.03-	AT/MT	F	L	Hatchback 4WD B47D20A		202052OL	Drive Shaft	31	27	56.8		550
	2015.03-	AT/MT	F	R	Hatchback 4WD B47D20A		202053OL	Drive Shaft	31	27	56.8		841
	2015.03-	MT	R	L	Hatchback 4WD B47D20A		205066OL	Drive Shaft	28	27		71	743
	2015.03-	MT	R	R	Hatchback 4WD B47D20A		205067OL	Drive Shaft	28	27		71	796
	2015.03-2019.06	AT/MT	F	L	Hatchback 4WD B47D20A		202052OL	Drive Shaft	31	27	56.8		550
	2015.03-2019.06	AT/MT	F	R	Hatchback 4WD B47D20A		202053OL	Drive Shaft	31	27	56.8		841
	2015.03-2019.06	MT	R	L	Hatchback 4WD B47D20A		205066OL	Drive Shaft	28	27		71	743
	2015.03-2019.06	MT	R	R	Hatchback 4WD B47D20A		205067OL	Drive Shaft	28	27		71	796
118i													
1.5 (100 kw)	2015.03-	AT/MT	R	L	Hatchback RWD B38B15A		205066OL	Drive Shaft	28	27		71	743
	2015.03-	AT/MT	R	R	Hatchback RWD B38B15A		205067OL	Drive Shaft	28	27		71	796
	2015.07-2019.06	6MT	R	L	Hatchback RWD B38B15A		205066OL	Drive Shaft	28	27		71	743
	2015.07-2019.06	6MT	R	R	Hatchback RWD B38B15A		205067OL	Drive Shaft	28	27		71	796
	2015.07-2019.06	MT	R	L	Hatchback Van RWD B38B15A		205066OL	Drive Shaft	28	27		71	743
	2015.07-2019.06	MT	R	R	Hatchback Van RWD B38B15A		205067OL	Drive Shaft	28	27		71	796
	2020.11-	6MT	F	L	Hatchback FWD B38A15A		202631OL	Drive Shaft	31	34	56		563
	2020.11-	6MT	F	R	Hatchback FWD B38A15A		202632OL	Drive Shaft	31	34	56		920
1.5 (103 kw)	2019.07-	6MT	F	L	Hatchback FWD B38A15A		202631OL	Drive Shaft	31	34	56		563
	2019.07-	6MT	F	R	Hatchback FWD B38A15A		202632OL	Drive Shaft	31	34	56		920
1.6 (100 kw)	2015.03-	MT	R	L	Hatchback RWD N13B16A		205066OL	Drive Shaft	28	27		71	743
	2015.03-	MT	R	R	Hatchback RWD N13B16A		205067OL	Drive Shaft	28	27		71	796
	2015.03-2015.06	MT	R	L	Hatchback RWD N13B16A		205066OL	Drive Shaft	28	27		71	743





 YEAR	TRANSM.	F/R	L/R	BODY STYLE & DRIVE TYPE & ENGINE	REMARKS	GSP Ref.	 PRODUCT	ABS	Technical Specifications				
									A	B	C	H	L
BMW 118i													
1.6 (100 kw)	2015.03-2015.06	MT	R	R	Hatchback RWD N13B16A	205067OL	Drive Shaft		28	27		71	796
1.6 (125 kw)	2011.06-	MT	R	L	Hatchback RWD N13B16A	205066OL	Drive Shaft		28	27		71	743
	2011.06-	MT	R	R	Hatchback RWD N13B16A	205067OL	Drive Shaft		28	27		71	796
	2011.06-2015.11	AT/MT	R	L	Hatchback RWD N13B16A	205066OL	Drive Shaft		28	27		71	743
	2011.06-2015.11	AT/MT	R	R	Hatchback RWD N13B16A	205067OL	Drive Shaft		28	27		71	796
120d													
2.0 (120 kw)	2011.07-2019.06	AT/MT	R	L	Hatchback RWD B47D20A/N47D20C	205066OL	Drive Shaft		28	27		71	743
	2011.07-2019.06	AT/MT	R	R	Hatchback RWD B47D20A/N47D20C	205067OL	Drive Shaft		28	27		71	796
	2013.07-	AT/MT	R	L	Hatchback RWD B47D20A/N47D20C	205066OL	Drive Shaft		28	27		71	743
	2013.07-	AT/MT	R	R	Hatchback RWD B47D20A/N47D20C	205067OL	Drive Shaft		28	27		71	796
2.0 (135 kw)	2011.07-2015.02	AT/MT	R	L	Hatchback RWD N47D20C	205066OL	Drive Shaft		28	27		71	743
	2011.07-2015.02	AT/MT	R	R	Hatchback RWD N47D20C	205067OL	Drive Shaft		28	27		71	796
	2012.08-2015.02	AT/MT	R	L	Hatchback RWD N47D20C	205066OL	Drive Shaft		28	27		71	743
	2012.08-2015.02	AT/MT	R	R	Hatchback RWD N47D20C	205067OL	Drive Shaft		28	27		71	796
2.0 (140 kw)	2015.03-	AT/MT	R	L	Hatchback RWD B47D20A	205066OL	Drive Shaft		28	27		71	743
	2015.03-	AT/MT	R	R	Hatchback RWD B47D20A	205067OL	Drive Shaft		28	27		71	796
	2015.03-2019.06	AT/MT	R	L	Hatchback RWD B47D20A	205066OL	Drive Shaft		28	27		71	743
	2015.03-2019.06	AT/MT	R	R	Hatchback RWD B47D20A	205067OL	Drive Shaft		28	27		71	796
	2015.03-2019.06	AT/MT	R	L	Hatchback Van RWD B47D20A	205066OL	Drive Shaft		28	27		71	743
	2015.03-2019.06	AT/MT	R	R	Hatchback Van RWD B47D20A	205067OL	Drive Shaft		28	27		71	796
2.0 (147 kw)	2011.07-2015.02	AT/MT	R	L	Hatchback RWD N47D20C	205066OL	Drive Shaft		28	27		71	743
	2011.07-2015.02	AT/MT	R	R	Hatchback RWD N47D20C	205067OL	Drive Shaft		28	27		71	796
	2012.01-2015.02	AT/MT	R	L	Hatchback RWD N47D20C	205066OL	Drive Shaft		28	27		71	743
	2012.01-2015.02	AT/MT	R	R	Hatchback RWD N47D20C	205067OL	Drive Shaft		28	27		71	796
120d xDrive													
2.0 (135 kw)	2012.02-2015.02	MT	F	L	Hatchback 4WD N47D20C	202052OL	Drive Shaft		31	27	56.8		550
	2012.02-2015.02	MT	F	R	Hatchback 4WD N47D20C	202053OL	Drive Shaft		31	27	56.8		841
	2012.02-2015.02	MT	R	L	Hatchback 4WD N47D20C	205066OL	Drive Shaft		28	27		71	743
	2012.02-2015.02	MT	R	R	Hatchback 4WD N47D20C	205067OL	Drive Shaft		28	27		71	796
	2012.11-2015.02	MT	F	L	Hatchback 4WD N47D20C	202052OL	Drive Shaft		31	27	56.8		550
	2012.11-2015.02	MT	F	R	Hatchback 4WD N47D20C	202053OL	Drive Shaft		31	27	56.8		841
	2012.11-2015.02	MT	R	L	Hatchback 4WD N47D20C	205066OL	Drive Shaft		28	27		71	743
	2012.11-2015.02	MT	R	R	Hatchback 4WD N47D20C	205067OL	Drive Shaft		28	27		71	796
2.0 (140 kw)	2015.03-	AT/MT	F	L	Hatchback 4WD B47D20A	202052OL	Drive Shaft		31	27	56.8		550
	2015.03-	AT/MT	F	R	Hatchback 4WD B47D20A	202053OL	Drive Shaft		31	27	56.8		841
	2015.03-	AT	R	L	Hatchback 4WD B47D20A	205066OL	Drive Shaft		28	27		71	743
	2015.03-	AT	R	R	Hatchback 4WD B47D20A	205067OL	Drive Shaft		28	27		71	796
	2015.03-2019.06	AT/MT	F	L	Hatchback 4WD B47D20A	202052OL	Drive Shaft		31	27	56.8		550
	2015.03-2019.06	AT/MT	F	R	Hatchback 4WD B47D20A	202053OL	Drive Shaft		31	27	56.8		841
	2015.03-2019.06	AT	R	L	Hatchback 4WD B47D20A	205066OL	Drive Shaft		28	27		71	743
	2015.03-2019.06	AT	R	R	Hatchback 4WD B47D20A	205067OL	Drive Shaft		28	27		71	796
	2019.07-	8AT	R	L/R	Hatchback 4WD B47C20B	202176OL	Drive Shaft		31	27	56		731
2.0 (147 kw)	2012.02-2015.02	MT	F	L	Hatchback 4WD N47D20C	202052OL	Drive Shaft		31	27	56.8		550
	2012.02-2015.02	MT	F	R	Hatchback 4WD N47D20C	202053OL	Drive Shaft		31	27	56.8		841
	2012.02-2015.02	MT	R	L	Hatchback 4WD N47D20C	205066OL	Drive Shaft		28	27		71	743
	2012.02-2015.02	MT	R	R	Hatchback 4WD N47D20C	205067OL	Drive Shaft		28	27		71	796
	2012.11-2015.02	MT	F	L	Hatchback 4WD N47D20C	202052OL	Drive Shaft		31	27	56.8		550
	2012.11-2015.02	MT	F	R	Hatchback 4WD N47D20C	202053OL	Drive Shaft		31	27	56.8		841
	2012.11-2015.02	MT	R	L	Hatchback 4WD N47D20C	205066OL	Drive Shaft		28	27		71	743
	2012.11-2015.02	MT	R	R	Hatchback 4WD N47D20C	205067OL	Drive Shaft		28	27		71	796
120i													
1.6 (130 kw)	2015.03-	MT	R	L	Hatchback RWD N13B16A	205066OL	Drive Shaft		28	27		71	743
	2015.03-	MT	R	R	Hatchback RWD N13B16A	205067OL	Drive Shaft		28	27		71	796
	2015.03-2016.06	MT	R	L	Hatchback RWD N13B16A	205066OL	Drive Shaft		28	27		71	743
	2015.03-2016.06	MT	R	R	Hatchback RWD N13B16A	205067OL	Drive Shaft		28	27		71	796
2.0 (135 kw)	2016.07-	MT	R	L	Hatchback RWD B48B20A	205066OL	Drive Shaft		28	27		71	743
	2016.07-	MT	R	R	Hatchback RWD B48B20A	205067OL	Drive Shaft		28	27		71	796
	2016.07-2019.06	MT	R	L	Hatchback RWD B48B20A	205066OL	Drive Shaft		28	27		71	743
	2016.07-2019.06	MT	R	R	Hatchback RWD B48B20A	205067OL	Drive Shaft		28	27		71	796
123d													
2.0 (150 kw)	2007.07-2011.06	AT	R	R	Hatchback RWD N47D20B/N47D20D	205134OL	Drive Shaft		30			73	671
	2007.07-2012.09	AT	R	R	Hatchback RWD N47D20B/N47D20D	205134OL	Drive Shaft		30			73	671
123d Cabrio													
2.0 (150 kw)	2008.09-2013.12	AT	R	R	Cabriolet RWD N47D20B/N47D20D	205134OL	Drive Shaft		30			73	671



		TRANSM.	F/R	L/R	BODY STYLE & DRIVE TYPE & ENGINE	REMARKS	GSP Ref.		ABS	Technical Specifications									
										A	B	C	H	L					
BMW																			
123d Coupe																			
2.0 (150 kw)	2007.09-	AT	R	R	Coupe RWD N47D20B/N47D20D		2051340L	Drive Shaft		30			73	671					
125i																			
2.0 (160 kw)	2011.12-2019.12	8AT/6MT	R	L	Hatchback RWD N20B20A		2050660L	Drive Shaft		28	27		71	743					
	2011.12-2019.12	8AT/6MT	R	R	Hatchback RWD N20B20A		2050670L	Drive Shaft		28	27		71	796					
	2012.03-2017.11	8AT/6MT	R	L	Hatchback RWD N20B20A		2050660L	Drive Shaft		28	27		71	743					
	2012.03-2017.11	8AT/6MT	R	R	Hatchback RWD N20B20A		2050670L	Drive Shaft		28	27		71	796					
	2014.11-2017.11	MT	R	L	Hatchback RWD N20B20A		2050660L	Drive Shaft		28	27		71	743					
	2014.11-2017.11	MT	R	R	Hatchback RWD N20B20A		2050670L	Drive Shaft		28	27		71	796					
2.0 (165 kw)	2015.10-	8AT	R	L	Hatchback RWD B48B20B		2050660L	Drive Shaft		28	27		71	743					
	2015.10-	8AT	R	R	Hatchback RWD B48B20B		2050670L	Drive Shaft		28	27		71	796					
	2016.07-2019.06	8AT	R	L	Hatchback RWD B48B20B		2050660L	Drive Shaft		28	27		71	743					
	2016.07-2019.06	8AT	R	R	Hatchback RWD B48B20B		2050670L	Drive Shaft		28	27		71	796					
2.0 (175 kw)	2012.03-2017.11	AT/MT	R	L	Hatchback RWD N20B20A		2050660L	Drive Shaft		28	27		71	743					
	2012.03-2017.11	AT/MT	R	R	Hatchback RWD N20B20A		2050670L	Drive Shaft		28	27		71	796					
	2012.07-	AT/MT	R	L	Hatchback RWD N20B20A		2050660L	Drive Shaft		28	27		71	743					
	2012.07-	AT/MT	R	R	Hatchback RWD N20B20A		2050670L	Drive Shaft		28	27		71	796					
130i																			
3.0 (190 kw)	2005.03-2012.09	AT/MT	R	R	Hatchback RWD N52B30A/N52B30B/N52B30BF		2051340L	Drive Shaft		30			73	671					
	2007.03-2011.06	AT/MT	R	R	Hatchback RWD N52B30A/N52B30B/N52B30BF		2051340L	Drive Shaft		30			73	671					
3.0 (195 kw)	2005.09-2007.02	MT	R	R	Hatchback RWD N52B30A/N52B30BF		2051340L	Drive Shaft		30			73	671					
	2007.03-2012.09	MT	R	R	Hatchback RWD N52B30A/N52B30B/N52B30BF		2051340L	Drive Shaft		30			73	671					
135i Cabrio																			
3.0 (225 kw)	2008.03-2013.10	AT	R	R	Cabriolet RWD N54B30A/N55B30A		2051340L	Drive Shaft		30			73	671					
135i Coupe																			
3.0 (225 kw)	2007.09-2013.10	AT	R	R	Coupe RWD N54B30A/N55B30A		2051340L	Drive Shaft		30			73	671					
214d Active Tourer																			
1.5 (70 kw)	2015.01-2018.02	6MT	F	L	MPV FWD B37C15A		2026310L	Drive Shaft		31	34	56		563					
	2015.01-2018.02	6MT	F	R	MPV FWD B37C15A		2026320L	Drive Shaft		31	34	56		920					
214d Gran Tourer																			
1.5 (70 kw)	2015.03-2018.02	6MT	F	L	MPV FWD B37C15A		2026310L	Drive Shaft		31	34	56		563					
	2015.03-2018.02	6MT	F	R	MPV FWD B37C15A		2026320L	Drive Shaft		31	34	56		920					
216d Active Tourer																			
1.5 (85 kw)	2014.09-	6AT	F	L	MPV FWD B37C15A		2037120L	Drive Shaft		31	26	56		541					
	2014.09-	6AT	F	R	MPV FWD B37C15A		2037130L	Drive Shaft		31	26	56		905					
216d Gran Tourer																			
1.5 (85 kw)	2015.03-	6AT	F	L	MPV FWD B37C15A		2037120L	Drive Shaft		31	26	56		541					
	2015.03-	6AT	F	R	MPV FWD B37C15A		2037130L	Drive Shaft		31	26	56		905					
216i Active Tourer																			
1.5 (75 kw)	2015.11-2018.02	6MT	F	L	MPV FWD B38A15A		2026310L	Drive Shaft		31	34	56		563					
	2015.11-2018.02	6MT	F	R	MPV FWD B38A15A		2026320L	Drive Shaft		31	34	56		920					
1.5 (80 kw)	2018.03-	6MT	F	L	MPV FWD B38A15A		2026310L	Drive Shaft		31	34	56		563					
	2018.03-	6MT	F	R	MPV FWD B38A15A		2026320L	Drive Shaft		31	34	56		920					
216i Gran Tourer																			
1.5 (75 kw)	2015.07-2018.02	6MT	F	L	MPV FWD B38A15A		2026310L	Drive Shaft		31	34	56		563					
	2015.07-2018.02	6MT	F	R	MPV FWD B38A15A		2026320L	Drive Shaft		31	34	56		920					
1.5 (80 kw)	2018.03-	6MT	F	L	MPV FWD B38A15A		2026310L	Drive Shaft		31	34	56		563					
	2018.03-	6MT	F	R	MPV FWD B38A15A		2026320L	Drive Shaft		31	34	56		920					
218d Active Tourer																			
2.0 (100 kw)	2014.09-	8AT	F	L	MPV FWD B47C20A/B47C20B	For Engine Code:B47C20A.Diameter:25mm	2021770L	Drive Shaft		31	28	56		538					
2.0 (110 kw)	2014.07-	8AT	F	L	MPV FWD B47C20A/B47C20B	For Engine Code:B47C20A	2021770L	Drive Shaft		31	28	56		538					
	2014.07-	8AT	F	L	MPV Van FWD B47C20A/B47C20B	For Engine Code:B47C20A	2021770L	Drive Shaft		31	28	56		538					
218d Cabrio																			
2.0 (100 kw)	2015.07-	AT/MT	R	L	Cabriolet RWD B47D20A		2050660L	Drive Shaft		28	27		71	743					
	2015.07-	AT/MT	R	R	Cabriolet RWD B47D20A		2050670L	Drive Shaft		28	27		71	796					
2.0 (110 kw)	2015.07-	AT/MT	R	L	Cabriolet RWD B47D20A		2050660L	Drive Shaft		28	27		71	743					
	2015.07-	AT/MT	R	R	Cabriolet RWD B47D20A		2050670L	Drive Shaft		28	27		71	796					
218d Coupe																			
2.0 (100 kw)	2014.03-	8AT/6MT	R	L	Coupe RWD B47D20A/N47D20C		2050660L	Drive Shaft		28	27		71	743					
	2014.03-	8AT/6MT	R	R	Coupe RWD B47D20A/N47D20C		2050670L	Drive Shaft		28	27		71	796					
2.0 (105 kw)	2014.03-2015.06	AT/MT	R	L	Coupe RWD N47D20C		2050660L	Drive Shaft		28	27		71	743					
	2014.03-2015.06	AT/MT	R	R	Coupe RWD N47D20C		2050670L	Drive Shaft		28	27		71	796					
2.0 (110 kw)	2015.07-	AT	R	L	Coupe RWD B47D20A		2050660L	Drive Shaft		28	27		71	743					
	2015.07-	AT	R	R	Coupe RWD B47D20A		2050670L	Drive Shaft		28	27		71	796					



		TRANSM.	F/R	L/R	BODY STYLE & DRIVE TYPE & ENGINE	REMARKS	GSP Ref.		Technical Specifications				
									A	B	C	H	L
BMW													
218d Gran Tourer													
2.0 (100 kw)	2015.03-	8AT	F	L	MPV FWD B47C20A/B47C20B	For Engine Code:B47C20A,Diameter:25mm	2021770L	Drive Shaft	31	28	56		538
2.0 (110 kw)	2014.07-	8AT	F	L	MPV FWD B47C20A/B47C20B	For Engine Code:B47C20A	2021770L	Drive Shaft	31	28	56		538
	2014.07-	8AT	F	L	MPV Van FWD B47C20A/B47C20B	For Engine Code:B47C20A	2021770L	Drive Shaft	31	28	56		538
218d xDrive Active Tourer													
2.0 (100 kw)	2015.11-	8AT	F	L	MPV 4WD B47C20A/B47C20B	Diameter:25mm	2021770L	Drive Shaft	31	28	56		538
	2015.11-	8AT/6MT	F	R	MPV 4WD B47C20A/B47C20B		2026330L	Drive Shaft	31	35	56		499
	2015.11-	8AT/6MT	R	L/R	MPV 4WD B47C20A/B47C20B		2021760L	Drive Shaft	31	27	56		731
2.0 (110 kw)	2015.11-	8AT	F	L	MPV 4WD B47C20A/B47C20B	Diameter:25mm	2021770L	Drive Shaft	31	28	56		538
	2015.11-	8AT/6MT	F	R	MPV 4WD B47C20A/B47C20B		2026330L	Drive Shaft	31	35	56		499
	2015.11-	8AT/6MT	R	L/R	MPV 4WD B47C20A/B47C20B		2021760L	Drive Shaft	31	27	56		731
218d xDrive Gran Tourer													
2.0 (100 kw)	2015.03-	6MT	F	R	MPV 4WD B47C20A/B47C20B		2026330L	Drive Shaft	31	35	56		499
	2015.03-	8AT	F	L	MPV 4WD B47C20A/B47C20B	For Engine Code:B47C20A,Diameter:25mm	2021770L	Drive Shaft	31	28	56		538
	2015.03-	8AT	F	R	MPV 4WD B47C20A/B47C20B	For Engine Code:B47C20A	2026330L	Drive Shaft	31	35	56		499
	2015.03-	8AT/6MT	R	L/R	MPV 4WD B47C20A/B47C20B		2021760L	Drive Shaft	31	27	56		731
2.0 (110 kw)	2015.03-	6MT	F	R	MPV 4WD B47C20A/B47C20B		2026330L	Drive Shaft	31	35	56		499
	2015.03-	8AT	F	L	MPV 4WD B47C20A/B47C20B	For Engine Code:B47C20A,Diameter:25mm	2021770L	Drive Shaft	31	28	56		538
	2015.03-	8AT	F	R	MPV 4WD B47C20A/B47C20B	For Engine Code:B47C20A	2026330L	Drive Shaft	31	35	56		499
	2015.03-	8AT/6MT	R	L/R	MPV 4WD B47C20A/B47C20B		2021760L	Drive Shaft	31	27	56		731
218i Active Tourer													
1.5 (100 kw)	2014.07-	6AT	F	L	MPV FWD B38A15A		2037120L	Drive Shaft	31	26	56		541
	2014.07-	6AT	F	R	MPV FWD B38A15A		2037130L	Drive Shaft	31	26	56		905
	2014.07-	6MT	F	L	MPV FWD B38A15A		2026310L	Drive Shaft	31	34	56		563
	2014.07-	6MT	F	R	MPV FWD B38A15A		2026320L	Drive Shaft	31	34	56		920
1.5 (103 kw)	2018.03-	6MT	F	L	MPV FWD B38A15A		2026310L	Drive Shaft	31	34	56		563
	2018.03-	6MT	F	R	MPV FWD B38A15A		2026320L	Drive Shaft	31	34	56		920
	2018.03-	6MT	F	L	MPV Van FWD B38A15A		2026310L	Drive Shaft	31	34	56		563
	2018.03-	6MT	F	R	MPV Van FWD B38A15A		2026320L	Drive Shaft	31	34	56		920
218i Cabrio													
1.5 (100 kw)	2015.01-	6MT	R	L	Cabriolet RWD B38B15A		2050660L	Drive Shaft	28	27		71	743
	2015.01-	6MT	R	R	Cabriolet RWD B38B15A		2050670L	Drive Shaft	28	27		71	796
218i Coupe													
1.5 (100 kw)	2015.01-	6MT	R	L	Coupe RWD B38B15A		2050660L	Drive Shaft	28	27		71	743
	2015.01-	6MT	R	R	Coupe RWD B38B15A		2050670L	Drive Shaft	28	27		71	796
218i Gran Coupe													
1.5 (100 kw)	2020.11-	6MT	F	L	Coupe FWD B38A15A		2026310L	Drive Shaft	31	34	56		563
	2020.11-	6MT	F	R	Coupe FWD B38A15A		2026320L	Drive Shaft	31	34	56		920
1.5 (103 kw)	2019.11-	6MT	F	L	Coupe FWD B38A15A		2026310L	Drive Shaft	31	34	56		563
	2019.11-	6MT	F	R	Coupe FWD B38A15A		2026320L	Drive Shaft	31	34	56		920
218i Gran Tourer													
1.5 (100 kw)	2015.03-	6AT	F	L	MPV FWD B38A15A		2037120L	Drive Shaft	31	26	56		541
	2015.03-	6AT	F	R	MPV FWD B38A15A		2037130L	Drive Shaft	31	26	56		905
	2015.03-	6MT	F	L	MPV FWD B38A15A		2026310L	Drive Shaft	31	34	56		563
	2015.03-	6MT	F	R	MPV FWD B38A15A		2026320L	Drive Shaft	31	34	56		920
1.5 (103 kw)	2017.04-	6MT	F	L	MPV FWD B38A15A		2026310L	Drive Shaft	31	34	56		563
	2017.04-	6MT	F	R	MPV FWD B38A15A		2026320L	Drive Shaft	31	34	56		920
	2017.04-	6MT	F	L	MPV Van FWD B38A15A		2026310L	Drive Shaft	31	34	56		563
	2017.04-	6MT	F	R	MPV Van FWD B38A15A		2026320L	Drive Shaft	31	34	56		920
220d Active Tourer													
2.0 (120 kw)	2014.11-	8AT	F	L	MPV FWD B47C20A/B47C20B	Diameter:25mm	2021770L	Drive Shaft	31	28	56		538
2.0 (140 kw)	2014.09-	8AT	F	L	MPV FWD B47C20A/B47C20B	Diameter:25mm	2021770L	Drive Shaft	31	28	56		538
	2014.11-	8AT	F	L	MPV Van FWD B47C20A/B47C20B	Diameter:25mm	2021770L	Drive Shaft	31	28	56		538
220d Cabrio													
2.0 (120 kw)	2014.11-	AT/MT	R	L	Cabriolet RWD B47D20A		2050660L	Drive Shaft	28	27		71	743
	2014.11-	AT/MT	R	R	Cabriolet RWD B47D20A		2050670L	Drive Shaft	28	27		71	796
2.0 (140 kw)	2014.10-	AT/MT	R	L	Cabriolet RWD B47D20A		2050660L	Drive Shaft	28	27		71	743
	2014.10-	AT/MT	R	R	Cabriolet RWD B47D20A		2050670L	Drive Shaft	28	27		71	796
220d Coupe													
2.0 (120 kw)	2014.11-	8AT/6MT	R	L	Coupe RWD B47D20A/N47D20C		2050660L	Drive Shaft	28	27		71	743
	2014.11-	8AT/6MT	R	R	Coupe RWD B47D20A/N47D20C		2050670L	Drive Shaft	28	27		71	796
2.0 (135 kw)	2013.10-	AT/MT	R	L	Coupe RWD N47D20C		2050660L	Drive Shaft	28	27		71	743
	2013.10-	AT/MT	R	R	Coupe RWD N47D20C		2050670L	Drive Shaft	28	27		71	796
2.0 (140 kw)	2014.11-	AT/MT	R	L	Coupe RWD B47D20A		2050660L	Drive Shaft	28	27		71	743
	2014.11-	AT/MT	R	R	Coupe RWD B47D20A		2050670L	Drive Shaft	28	27		71	796
2.0 (147 kw)	2014.03-	AT/MT	R	L	Coupe RWD N47D20C		2050660L	Drive Shaft	28	27		71	743



		TRANSM.	F/R	L/R	BODY STYLE & DRIVE TYPE & ENGINE	REMARKS	GSP Ref.		PRODUCT	ABS	Technical Specifications									
											A	B	C	H	L					
BMW																				
220d Coupe																				
2.0 (147 kw)	2014.03-	AT/MT	R	R	Coupe RWD N47D20C		205067OL	Drive Shaft			28	27		71	796					
220d Gran Tourer																				
2.0 (120 kw)	2015.07-	8AT	F	L	MPV FWD B47C20A/B47C20B	For Engine Code:B47C20A,Diameter:25mm	202177OL	Drive Shaft			31	28	56		538					
2.0 (140 kw)	2014.07-	8AT	F	L	MPV FWD B47C20A/B47C20B	For Engine Code:B47C20A,Diameter:25mm	202177OL	Drive Shaft			31	28	56		538					
	2014.07-	8AT	F	L	MPV Van FWD B47C20A/B47C20B	For Engine Code:B47C20A,Diameter:25mm	202177OL	Drive Shaft			31	28	56		538					
220d xDrive Active Tourer																				
2.0 (120 kw)	2014.11-	8AT	F	L	MPV 4WD B47C20A/B47C20B	Diameter:25mm	202177OL	Drive Shaft			31	28	56		538					
	2014.11-	8AT	F	R	MPV 4WD B47C20A/B47C20B		202633OL	Drive Shaft			31	35	56		499					
	2014.11-	8AT	R	L/R	MPV 4WD B47C20A/B47C20B		202176OL	Drive Shaft			31	27	56		731					
2.0 (140 kw)	2014.09-	8AT	F	L	MPV 4WD B47C20A/B47C20B	Diameter:25mm	202177OL	Drive Shaft			31	28	56		538					
	2014.09-	8AT	F	R	MPV 4WD B47C20A/B47C20B		202633OL	Drive Shaft			31	35	56		499					
	2014.09-	8AT	R	L/R	MPV 4WD B47C20A/B47C20B		202176OL	Drive Shaft			31	27	56		731					
220d xDrive Coupe																				
2.0 (120 kw)	2015.03-	8AT	F	L	Coupe 4WD B47D20A		202052OL	Drive Shaft			31	27	56.8		550					
	2015.03-	8AT	F	R	Coupe 4WD B47D20A		202053OL	Drive Shaft			31	27	56.8		841					
	2015.03-	8AT	R	L	Coupe 4WD B47D20A		205066OL	Drive Shaft			28	27		71	743					
	2015.03-	8AT	R	R	Coupe 4WD B47D20A		205067OL	Drive Shaft			28	27		71	796					
2.0 (140 kw)	2015.01-	8AT	F	L	Coupe 4WD B47D20A		202052OL	Drive Shaft			31	27	56.8		550					
	2015.01-	8AT	F	R	Coupe 4WD B47D20A		202053OL	Drive Shaft			31	27	56.8		841					
	2015.01-	AT	R	L	Coupe 4WD B47D20A		205066OL	Drive Shaft			28	27		71	743					
	2015.01-	AT	R	R	Coupe 4WD B47D20A		205067OL	Drive Shaft			28	27		71	796					
220d xDrive Gran Tourer																				
2.0 (120 kw)	2015.03-	8AT	F	L	MPV 4WD B47C20A/B47C20B	For Engine Code:B47C20A,Diameter:25mm	202177OL	Drive Shaft			31	28	56		538					
	2015.03-	8AT	F	R	MPV 4WD B47C20A/B47C20B	For Engine Code:B47C20A	202633OL	Drive Shaft			31	35	56		499					
	2015.03-	8AT	R	L/R	MPV 4WD B47C20A/B47C20B		202176OL	Drive Shaft			31	27	56		731					
2.0 (140 kw)	2015.03-	8AT	F	L	MPV 4WD B47C20A/B47C20B	For Engine Code:B47C20A,Diameter:25mm	202177OL	Drive Shaft			31	28	56		538					
	2015.03-	8AT	F	R	MPV 4WD B47C20A/B47C20B	For Engine Code:B47C20A	202633OL	Drive Shaft			31	35	56		499					
	2015.03-	8AT	R	L/R	MPV 4WD B47C20A/B47C20B		202176OL	Drive Shaft			31	27	56		731					
220d xDrive Grand Coupe																				
2.0 (140 kw)	2019.11-	8AT	R	L/R	Coupe 4WD B47C20B		202176OL	Drive Shaft			31	27	56		731					
220i Active Tourer																				
2.0 (120 kw)	2014.11-	8AT	F	L	MPV FWD B48A20A	Diameter:25mm	202177OL	Drive Shaft			31	28	56		538					
2.0 (141 kw)	2014.03-	8AT	F	L	MPV FWD B48A20A/B48A20F		202177OL	Drive Shaft			31	28	56		538					
220i Cabrio																				
2.0 (135 kw)	2014.10-	AT/MT	R	L	Cabriolet RWD N20B20A/N20B20B		205066OL	Drive Shaft			28	27		71	743					
	2014.10-	AT/MT	R	R	Cabriolet RWD N20B20A/N20B20B		205067OL	Drive Shaft			28	27		71	796					
	2015.09-		R	L	Cabriolet RWD B48B20A		205066OL	Drive Shaft			28	27		71	743					
	2015.09-		R	R	Cabriolet RWD B48B20A		205067OL	Drive Shaft			28	27		71	796					
220i Coupe																				
2.0 (135 kw)	2013.10-	AT/MT	R	L	Coupe RWD N20B20A/N20B20B		205066OL	Drive Shaft			28	27		71	743					
	2013.10-	AT/MT	R	R	Coupe RWD N20B20A/N20B20B		205067OL	Drive Shaft			28	27		71	796					
	2015.09-		R	L	Coupe RWD B48B20A		205066OL	Drive Shaft			28	27		71	743					
	2015.09-		R	R	Coupe RWD B48B20A		205067OL	Drive Shaft			28	27		71	796					
220i Gran Tourer																				
2.0 (120 kw)	2015.03-	8AT	F	L	MPV FWD B48A20A	Diameter:25mm	202177OL	Drive Shaft			31	28	56		538					
2.0 (141 kw)	2015.03-	8AT	F	L	MPV FWD B48A20A	Diameter:25mm	202177OL	Drive Shaft			31	28	56		538					
225e xDrive Active Tourer																				
1.5 (92 kw)	2020.11-	6AT	F	L	MPV 4WD B38A15A		203712OL	Drive Shaft			31	26	56		541					
	2020.11-	6AT	F	R	MPV 4WD B38A15A		203713OL	Drive Shaft			31	26	56		905					
1.5 (100 kw)	2016.03-	6AT	F	L	MPV 4WD B38A15A		203712OL	Drive Shaft			31	26	56		541					
	2016.03-	6AT	F	R	MPV 4WD B38A15A		203713OL	Drive Shaft			31	26	56		905					
225i Active Tourer																				
2.0 (170 kw)	2014.09-	8AT	F	L	MPV FWD B48A20B	Diameter:25mm	202177OL	Drive Shaft			31	28	56		538					
225i xDrive Active Tourer																				
2.0 (170 kw)	2014.09-	8AT	F	L	MPV 4WD B48A20B	Diameter:25mm	202177OL	Drive Shaft			31	28	56		538					
	2014.09-	8AT	F	R	MPV 4WD B48A20B		202633OL	Drive Shaft			31	35	56		499					
	2014.09-	8AT	R	L/R	MPV 4WD B48A20B		202176OL	Drive Shaft			31	27	56		731					
228i Cabrio																				
2.0 (180 kw)	2014.10-	AT/MT	R	L	Cabriolet RWD N20B20A		205066OL	Drive Shaft			28	27		71	743					
	2014.10-	AT/MT	R	R	Cabriolet RWD N20B20A		205067OL	Drive Shaft			28	27		71	796					
228i Coupe																				
2.0 (180 kw)	2014.07-	AT/MT	R	L	Coupe RWD N20B20A		205066OL	Drive Shaft			28	27		71	743					
	2014.07-	AT/MT	R	R	Coupe RWD N20B20A		205067OL	Drive Shaft			28	27		71	796					





		TRANSM.	F/R	L/R	BODY STYLE & DRIVE TYPE & ENGINE	REMARKS	GSP Ref.		PRODUCT	ABS	Technical Specifications				
											A	B	C	H	L
BMW															
230i Cabrio															
2.0 (185 kw)	2016.07-	AT/MT	R	L	Cabriolet RWD B48B20B		2050660L	Drive Shaft			28	27		71	743
	2016.07-	AT/MT	R	R	Cabriolet RWD B48B20B		2050670L	Drive Shaft			28	27		71	796
230i Coupe															
2.0 (185 kw)	2016.07-	AT/MT	R	L	Coupe RWD B48B20B		2050660L	Drive Shaft			28	27		71	743
	2016.07-	AT/MT	R	R	Coupe RWD B48B20B		2050670L	Drive Shaft			28	27		71	796
3 ActiveHybrid															
3.0 (225 kw)	2012.07-2015.06	8AT	R	L	Saloon RWD N55B30A		2050660L	Drive Shaft			28	27		71	743
	2012.07-2015.06	8AT	R	R	Saloon RWD N55B30A		2050670L	Drive Shaft			28	27		71	796
316d															
2.0 (85 kw)	2012.03-2018.10	AT/MT	R	L	Saloon RWD B47D20A/N47D20C		2050660L	Drive Shaft			28	27		71	743
	2012.03-2018.10	AT/MT	R	R	Saloon RWD B47D20A/N47D20C		2050670L	Drive Shaft			28	27		71	796
316d Touring															
2.0 (85 kw)	2009.09-2012.10	6MT	R	R	Estate RWD N47D20C	For increased payload	2051340L	Drive Shaft			30			73	671
	2012.11-2019.06	AT/MT	R	L	Estate RWD B47D20A/N47D20C		2050660L	Drive Shaft			28	27		71	743
	2012.11-2019.06	AT/MT	R	R	Estate RWD B47D20A/N47D20C		2050670L	Drive Shaft			28	27		71	796
316i															
1.6 (100 kw)	2012.07-2016.08	AT/MT	R	R	Saloon RWD N13B16A		2050670L	Drive Shaft			28	27		71	796
	2012.07-2016.08	MT	R	L	Saloon RWD N13B16A		2050660L	Drive Shaft			28	27		71	743
316i Touring															
1.6 (100 kw)	2013.03-2015.06	MT	R	L	Estate RWD N13B16A		2050660L	Drive Shaft			28	27		71	743
	2013.03-2015.06	MT	R	R	Estate RWD N13B16A		2050670L	Drive Shaft			28	27		71	796
318d															
2.0 (100 kw)	2012.03-2018.10	AT/MT	R	L	Saloon RWD B47D20A/N47D20C		2050660L	Drive Shaft			28	27		71	743
	2012.03-2018.10	AT/MT	R	R	Saloon RWD B47D20A/N47D20C		2050670L	Drive Shaft			28	27		71	796
2.0 (105 kw)	2012.03-2015.06	AT/MT	R	L	Saloon RWD N47D20C		2050660L	Drive Shaft			28	27		71	743
	2012.03-2015.06	AT/MT	R	R	Saloon RWD N47D20C		2050670L	Drive Shaft			28	27		71	796
2.0 (110 kw)	2015.07-2018.10	AT/MT	R	L	Saloon RWD B47D20A		2050660L	Drive Shaft			28	27		71	743
	2015.07-2018.10	AT/MT	R	R	Saloon RWD B47D20A		2050670L	Drive Shaft			28	27		71	796
318d Gran Turismo															
2.0 (100 kw)	2013.03-	AT/MT	R	L	Hatchback RWD B47D20A/N47D20C		2050660L	Drive Shaft			28	27		71	743
	2013.03-	AT/MT	R	R	Hatchback RWD B47D20A/N47D20C		2050670L	Drive Shaft			28	27		71	796
2.0 (105 kw)	2013.03-2015.06	8AT/6MT	R	L	Hatchback RWD N47D20C		2050660L	Drive Shaft			28	27		71	743
	2013.03-2015.06	8AT/6MT	R	R	Hatchback RWD N47D20C		2050670L	Drive Shaft			28	27		71	796
2.0 (110 kw)	2016.06-	AT/MT	R	L	Hatchback RWD B47D20A		2050660L	Drive Shaft			28	27		71	743
	2016.06-	AT/MT	R	R	Hatchback RWD B47D20A		2050670L	Drive Shaft			28	27		71	796
318d Touring															
2.0 (90 kw)	2005.09-2007.08	6MT	R	R	Estate RWD M47D204D4		2051340L	Drive Shaft			30			73	671
2.0 (100 kw)	2007.09-2012.06	6AT/6MT	R	R	Estate RWD N47D20A/N47D20C	Not for increased payload Date To:2009.09/For increased payload	2051340L	Drive Shaft			30			73	671
	2012.06-2019.06	8AT/6MT	R	L	Estate RWD B47D20A/N47D20C		2050660L	Drive Shaft			28	27		71	743
	2012.06-2019.06	8AT/6MT	R	R	Estate RWD B47D20A/N47D20C		2050670L	Drive Shaft			28	27		71	796
2.0 (105 kw)	2007.09-2012.06	6AT/6MT	R	R	Estate RWD N47D20A/N47D20C	Not for increased payload Date To:2009.09/For increased payload	2051340L	Drive Shaft			30			73	671
	2012.11-2015.06	8AT/6MT	R	L	Estate RWD N47D20C		2050660L	Drive Shaft			28	27		71	743
	2012.11-2015.06	8AT/6MT	R	R	Estate RWD N47D20C		2050670L	Drive Shaft			28	27		71	796
2.0 (110 kw)	2015.07-2019.06	AT/MT	R	L	Estate RWD B47D20A		2050660L	Drive Shaft			28	27		71	743
	2015.07-2019.06	AT/MT	R	R	Estate RWD B47D20A		2050670L	Drive Shaft			28	27		71	796
318d xDrive															
2.0 (105 kw)	2013.07-2015.06	6MT	F	L	Saloon 4WD N47D20C		2020520L	Drive Shaft			31	27	56.8		550
	2013.07-2015.06	6MT	F	R	Saloon 4WD N47D20C		2020530L	Drive Shaft			31	27	56.8		841
	2013.07-2015.06	MT	R	L	Saloon 4WD N47D20C		2050660L	Drive Shaft			28	27		71	743
	2013.07-2015.06	MT	R	R	Saloon 4WD N47D20C		2050670L	Drive Shaft			28	27		71	796
2.0 (110 kw)	2015.07-2018.02	8AT/6MT	F	L	Saloon 4WD B47D20A		2020520L	Drive Shaft			31	27	56.8		550
	2015.07-2018.02	8AT/6MT	F	R	Saloon 4WD B47D20A		2020530L	Drive Shaft			31	27	56.8		841
	2015.07-2018.02	AT/MT	R	L	Saloon 4WD B47D20A		2050660L	Drive Shaft			28	27		71	743
	2015.07-2018.02	AT/MT	R	R	Saloon 4WD B47D20A		2050670L	Drive Shaft			28	27		71	796
318d xDrive Touring															
2.0 (105 kw)	2013.07-2015.06	6MT	F	L	Estate 4WD N47D20C		2020520L	Drive Shaft			31	27	56.8		550
	2013.07-2015.06	6MT	F	R	Estate 4WD N47D20C		2020530L	Drive Shaft			31	27	56.8		841
	2013.07-2015.06	MT	R	L	Estate 4WD N47D20C		2050660L	Drive Shaft			28	27		71	743
	2013.07-2015.06	MT	R	R	Estate 4WD N47D20C		2050670L	Drive Shaft			28	27		71	796
2.0 (110 kw)	2015.07-2018.02	6MT	F	L	Estate 4WD B47D20A		2020520L	Drive Shaft			31	27	56.8		550
	2015.07-2018.02	6MT	F	R	Estate 4WD B47D20A		2020530L	Drive Shaft			31	27	56.8		841
	2015.07-2018.02	MT	R	L	Estate 4WD B47D20A		2050660L	Drive Shaft			28	27		71	743
	2015.07-2018.02	MT	R	R	Estate 4WD B47D20A		2050670L	Drive Shaft			28	27		71	796



	 YEAR	TRANSM.	F/R	L/R	BODY STYLE & DRIVE TYPE & ENGINE	REMARKS	GSP Ref.	 PRODUCT	 ABS	Technical Specifications									
										A	B	C	H	L					
BMW 318i																			
1.5 (100 kw)	2015.07-2018.10	6MT	R	L	Saloon RWD B38B15A		2050660L	Drive Shaft		28	27		71	743					
	2015.07-2018.10	6MT	R	R	Saloon RWD B38B15A		2050670L	Drive Shaft		28	27		71	796					
318i Touring																			
1.5 (100 kw)	2015.07-2019.06	MT	R	L	Estate RWD B38B15A		2050660L	Drive Shaft		28	27		71	743					
	2015.07-2019.06	MT	R	R	Estate RWD B38B15A		2050670L	Drive Shaft		28	27		71	796					
320d																			
2.0 (110 kw)	2004.06-2007.09	SAT/6MT	R	R	Saloon RWD M47D204D4	For government vehicles	2051340L	Drive Shaft		30			73	671					
2.0 (120 kw)	2004.12-2011.10	SAT/6AT/6MT	R	R	Saloon RWD M47D204D4/N47D20A/N47D20C	For police vehicles	2051340L	Drive Shaft		30			73	671					
	2011.11-2018.10	AT/MT	R	L	Saloon RWD B47D20A/N47D20C		2050660L	Drive Shaft		28	27		71	743					
	2011.11-2018.10	AT/MT	R	R	Saloon RWD B47D20A/N47D20C		2050670L	Drive Shaft		28	27		71	796					
2.0 (130 kw)	2007.09-2010.02	6AT/6MT	R	R	Saloon RWD N47D20A/N47D20C	For police vehicles	2051340L	Drive Shaft		30			73	671					
2.0 (135 kw)	2010.03-2011.10	6AT/6MT	R	R	Saloon RWD N47D20C	For police vehicles	2051340L	Drive Shaft		30			73	671					
	2011.11-2016.03	AT/MT	R	L	Saloon RWD N47D20C		2050660L	Drive Shaft		28	27		71	743					
	2011.11-2016.03	AT/MT	R	R	Saloon RWD N47D20C		2050670L	Drive Shaft		28	27		71	796					
2.0 (140 kw)	2015.07-2018.10	AT/MT	R	L	Saloon RWD B47D20A		2050660L	Drive Shaft		28	27		71	743					
	2015.07-2018.10	AT/MT	R	R	Saloon RWD B47D20A		2050670L	Drive Shaft		28	27		71	796					
2.0 (147 kw)	2011.11-2016.03	AT/MT	R	L	Saloon RWD N47D20C		2050660L	Drive Shaft		28	27		71	743					
	2011.11-2016.03	AT/MT	R	R	Saloon RWD N47D20C		2050670L	Drive Shaft		28	27		71	796					
320d Cabrio																			
2.0 (120 kw)	2008.01-2013.12	AT/MT	R	R	Cabriolet RWD N47D20A/N47D20C		2051340L	Drive Shaft		30			73	671					
2.0 (130 kw)	2008.03-2010.02	AT/MT	R	R	Cabriolet RWD N47D20A/N47D20C		2051340L	Drive Shaft		30			73	671					
2.0 (135 kw)	2010.03-	AT/MT	R	R	Cabriolet RWD N47D20C		2051340L	Drive Shaft		30			73	671					
2.0 (145 kw)	2007.09-2010.02	AT/MT	R	R	Cabriolet RWD N47D20A/N47D20C		2051340L	Drive Shaft		30			73	671					
2.0 (147 kw)	2010.03-2013.10	AT/MT	R	R	Cabriolet RWD N47D20C		2051340L	Drive Shaft		30			73	671					
320d Gran Turismo																			
2.0 (120 kw)	2013.03-	AT/MT	R	L	Hatchback RWD B47D20A/N47D20C		2050660L	Drive Shaft		28	27		71	743					
	2013.03-	AT/MT	R	R	Hatchback RWD B47D20A/N47D20C		2050670L	Drive Shaft		28	27		71	796					
2.0 (135 kw)	2013.03-2015.06	8AT/6MT	R	L	Hatchback RWD N47D20C		2050660L	Drive Shaft		28	27		71	743					
	2013.03-2015.06	8AT/6MT	R	R	Hatchback RWD N47D20C		2050670L	Drive Shaft		28	27		71	796					
2.0 (140 kw)	2015.07-	AT/MT	R	L	Hatchback RWD B47D20A		2050660L	Drive Shaft		28	27		71	743					
	2015.07-	AT/MT	R	R	Hatchback RWD B47D20A		2050670L	Drive Shaft		28	27		71	796					
2.0 (147 kw)	2013.03-2015.06	AT/MT	R	L	Hatchback RWD N47D20C		2050660L	Drive Shaft		28	27		71	743					
	2013.03-2015.06	AT/MT	R	R	Hatchback RWD N47D20C		2050670L	Drive Shaft		28	27		71	796					
320d Touring																			
2.0 (110 kw)	2004.12-2007.08	6AT/6MT	R	R	Estate RWD M47D204D4		2051340L	Drive Shaft		30			73	671					
2.0 (120 kw)	2005.06-2012.06	SAT/6AT/6MT	R	R	Estate RWD M47D204D4/N47D20A/N47D20C	For increased payload/For vehicles with active steering	2051340L	Drive Shaft		30			73	671					
	2012.07-2019.06	AT/MT	R	L	Estate RWD B47D20A/N47D20C		2050660L	Drive Shaft		28	27		71	743					
	2012.07-2019.06	AT/MT	R	R	Estate RWD B47D20A/N47D20C		2050670L	Drive Shaft		28	27		71	796					
2.0 (130 kw)	2007.06-2012.10	SAT/6AT/6MT	R	R	Estate RWD N47D20A/N47D20C	For increased payload/For vehicles with active steering	2051340L	Drive Shaft		30			73	671					
2.0 (135 kw)	2010.03-2012.10	6AT/6MT	R	R	Estate RWD N47D20C	For increased payload/For vehicles with active steering	2051340L	Drive Shaft		30			73	671					
	2012.07-2016.02	AT/MT	R	L	Estate RWD N47D20C		2050660L	Drive Shaft		28	27		71	743					
	2012.07-2016.02	AT/MT	R	R	Estate RWD N47D20C		2050670L	Drive Shaft		28	27		71	796					
2.0 (140 kw)	2015.07-2019.06	AT/MT	R	L	Estate RWD B47D20A		2050660L	Drive Shaft		28	27		71	743					
	2015.07-2019.06	AT/MT	R	R	Estate RWD B47D20A		2050670L	Drive Shaft		28	27		71	796					
2.0 (145 kw)	2007.02-2010.02	6AT/6MT	R	R	Estate RWD N47D20A/N47D20C	For increased payload/For vehicles with active steering	2051340L	Drive Shaft		30			73	671					
2.0 (147 kw)	2010.03-2012.05	6AT/6MT	R	R	Estate RWD N47D20C	For increased payload/For vehicles with active steering	2051340L	Drive Shaft		30			73	671					
	2012.07-2016.02	AT/MT	R	L	Estate RWD N47D20C		2050660L	Drive Shaft		28	27		71	743					
	2012.07-2016.02	AT/MT	R	R	Estate RWD N47D20C		2050670L	Drive Shaft		28	27		71	796					
320d xDrive																			
2.0 (120 kw)	2008.07-2011.12	6AT/6MT	R	R	Saloon 4WD N47D20C		2051340L	Drive Shaft		30			73	671					
	2012.08-2018.10	8AT/6MT	F	L	Saloon 4WD B47D20A/N47D20C		2020520L	Drive Shaft		31	27	56.8		550					
	2012.08-2018.10	8AT/6MT	F	R	Saloon 4WD B47D20A/N47D20C		2020530L	Drive Shaft		31	27	56.8		841					
	2012.08-2018.10	AT/MT	R	L	Saloon 4WD B47D20A/N47D20C		2050660L	Drive Shaft		28	27		71	743					
	2012.08-2018.10	AT/MT	R	R	Saloon 4WD B47D20A/N47D20C		2050670L	Drive Shaft		28	27		71	796					
2.0 (130 kw)	2008.09-2010.02	6AT/6MT	R	R	Saloon 4WD N47D20A/N47D20C		2051340L	Drive Shaft		30			73	671					
2.0 (135 kw)	2010.03-2011.10	6AT/6MT	R	R	Saloon 4WD N47D20C		2051340L	Drive Shaft		30			73	671					
	2012.08-2015.06	8AT/6MT	F	L	Saloon 4WD N47D20C		2020520L	Drive Shaft		31	27	56.8		550					
	2012.08-2015.06	8AT/6MT	F	R	Saloon 4WD N47D20C		2020530L	Drive Shaft		31	27	56.8		841					
	2012.08-2015.06	8AT/6MT	R	L	Saloon 4WD N47D20C		2050660L	Drive Shaft		28	27		71	743					
	2012.08-2015.06	8AT/6MT	R	R	Saloon 4WD N47D20C		2050670L	Drive Shaft		28	27		71	796					
2.0 (140 kw)	2015.07-2018.10	AT/MT	F	L	Saloon 4WD B47D20A		2020520L	Drive Shaft		31	27	56.8		550					
	2015.07-2018.10	AT/MT	F	R	Saloon 4WD B47D20A		2020530L	Drive Shaft		31	27	56.8		841					
	2015.07-2018.10	AT/MT	R	L	Saloon 4WD B47D20A		2050660L	Drive Shaft		28	27		71	743					
	2015.07-2018.10	AT/MT	R	R	Saloon 4WD B47D20A		2050670L	Drive Shaft		28	27		71	796					
2.0 (147 kw)	2012.08-2015.06	8AT/6MT	F	L	Saloon 4WD N47D20C		2020520L	Drive Shaft		31	27	56.8		550					



		TRANSM.	F/R	L/R	BODY STYLE & DRIVE TYPE & ENGINE	REMARKS	GSP Ref.		ABS	Technical Specifications				
										A	B	C	H	L
BMW														
320d xDrive														
2.0 (147 kw)	2012.08-2015.06	8AT/6MT	F	R	Saloon 4WD N47D20C		2020530L	Drive Shaft		31	27	56.8		841
	2012.08-2015.06	AT/MT	R	L	Saloon 4WD N47D20C		2050660L	Drive Shaft		28	27		71	743
	2012.08-2015.06	AT/MT	R	R	Saloon 4WD N47D20C		2050670L	Drive Shaft		28	27		71	796
320d xDrive Coupe														
2.0 (120 kw)	2008.09-2013.06	AT/MT	R	R	Coupe 4WD N47D20C		2051340L	Drive Shaft		30			73	671
2.0 (130 kw)	2008.09-2010.02	6AT/6MT	R	R	Coupe 4WD N47D20C		2051340L	Drive Shaft		30			73	671
2.0 (135 kw)	2010.03-2013.06	6AT/6MT	R	R	Coupe 4WD N47D20C		2051340L	Drive Shaft		30			73	671
2.0 (145 kw)	2008.09-2010.02	6AT/6MT	R	R	Coupe 4WD N47D20C		2051340L	Drive Shaft		30			73	671
2.0 (147 kw)	2010.03-2013.06	AT/MT	R	R	Coupe 4WD N47D20C		2051340L	Drive Shaft		30			73	671
320d xDrive Gran Turismo														
2.0 (120 kw)	2013.07-	AT/MT	F	L	Hatchback 4WD B47D20A/N47D20C		2020520L	Drive Shaft		31	27	56.8		550
	2013.07-	AT/MT	F	R	Hatchback 4WD B47D20A/N47D20C		2020530L	Drive Shaft		31	27	56.8		841
	2013.07-	AT/MT	R	L	Hatchback 4WD B47D20A/N47D20C		2050660L	Drive Shaft		28	27		71	743
	2013.07-	AT/MT	R	R	Hatchback 4WD B47D20A/N47D20C		2050670L	Drive Shaft		28	27		71	796
2.0 (135 kw)	2013.07-2015.06	AT/MT	F	L	Hatchback 4WD N47D20C		2020520L	Drive Shaft		31	27	56.8		550
	2013.07-2015.06	AT/MT	F	R	Hatchback 4WD N47D20C		2020530L	Drive Shaft		31	27	56.8		841
	2013.07-2015.06	AT/MT	R	L	Hatchback 4WD N47D20C		2050660L	Drive Shaft		28	27		71	743
	2013.07-2015.06	AT/MT	R	R	Hatchback 4WD N47D20C		2050670L	Drive Shaft		28	27		71	796
2.0 (140 kw)	2015.07-	AT/MT	F	L	Hatchback 4WD B47D20A		2020520L	Drive Shaft		31	27	56.8		550
	2015.07-	AT/MT	F	R	Hatchback 4WD B47D20A		2020530L	Drive Shaft		31	27	56.8		841
	2015.07-	AT/MT	R	L	Hatchback 4WD B47D20A		2050660L	Drive Shaft		28	27		71	743
	2015.07-	AT/MT	R	R	Hatchback 4WD B47D20A		2050670L	Drive Shaft		28	27		71	796
2.0 (147 kw)	2013.07-2015.06	AT/MT	F	L	Hatchback 4WD N47D20C		2020520L	Drive Shaft		31	27	56.8		550
	2013.07-2015.06	AT/MT	F	R	Hatchback 4WD N47D20C		2020530L	Drive Shaft		31	27	56.8		841
	2013.07-2015.06	AT/MT	R	L	Hatchback 4WD N47D20C		2050660L	Drive Shaft		28	27		71	743
	2013.07-2015.06	AT/MT	R	R	Hatchback 4WD N47D20C		2050670L	Drive Shaft		28	27		71	796
320d xDrive Touring														
2.0 (120 kw)	2009.07-2012.10	6AT/6MT	R	R	Estate 4WD N47D20C		2051340L	Drive Shaft		30			73	671
	2012.06-2019.06	8AT/6MT	F	L	Estate 4WD B47D20A/N47D20C		2020520L	Drive Shaft		31	27	56.8		550
	2012.06-2019.06	8AT/6MT	F	R	Estate 4WD B47D20A/N47D20C		2020530L	Drive Shaft		31	27	56.8		841
	2012.06-2019.06	8AT/6MT	R	L	Estate 4WD B47D20A/N47D20C		2050660L	Drive Shaft		28	27		71	743
	2012.06-2019.06	8AT/6MT	R	R	Estate 4WD B47D20A/N47D20C		2050670L	Drive Shaft		28	27		71	796
2.0 (130 kw)	2008.09-2010.02	6AT/6MT	R	R	Estate 4WD N47D20C		2051340L	Drive Shaft		30			73	671
2.0 (135 kw)	2010.03-2012.06	AT/MT	R	R	Estate 4WD N47D20C		2051340L	Drive Shaft		30			73	671
	2013.03-2015.06	AT/MT	F	L	Estate 4WD N47D20C		2020520L	Drive Shaft		31	27	56.8		550
	2013.03-2015.06	AT/MT	F	R	Estate 4WD N47D20C		2020530L	Drive Shaft		31	27	56.8		841
	2013.03-2015.06	AT/MT	R	L	Estate 4WD N47D20C		2050660L	Drive Shaft		28	27		71	743
	2013.03-2015.06	AT/MT	R	R	Estate 4WD N47D20C		2050670L	Drive Shaft		28	27		71	796
2.0 (140 kw)	2015.07-2019.06	AT/MT	F	L	Estate 4WD B47D20A		2020520L	Drive Shaft		31	27	56.8		550
	2015.07-2019.06	AT/MT	F	R	Estate 4WD B47D20A		2020530L	Drive Shaft		31	27	56.8		841
	2015.07-2019.06	AT/MT	R	L	Estate 4WD B47D20A		2050660L	Drive Shaft		28	27		71	743
	2015.07-2019.06	AT/MT	R	R	Estate 4WD B47D20A		2050670L	Drive Shaft		28	27		71	796
2.0 (145 kw)	2008.02-2010.02	AT/MT	R	R	Estate 4WD N47D20C		2051340L	Drive Shaft		30			73	671
2.0 (147 kw)	2010.03-2012.05	AT/MT	R	R	Estate 4WD N47D20C		2051340L	Drive Shaft		30			73	671
	2013.03-2015.06	8AT/6MT	F	L	Estate 4WD N47D20C		2020520L	Drive Shaft		31	27	56.8		550
	2013.03-2015.06	8AT/6MT	F	R	Estate 4WD N47D20C		2020530L	Drive Shaft		31	27	56.8		841
	2013.03-2015.06	AT/MT	R	L	Estate 4WD N47D20C		2050660L	Drive Shaft		28	27		71	743
	2013.03-2015.06	AT/MT	R	R	Estate 4WD N47D20C		2050670L	Drive Shaft		28	27		71	796
320i														
1.6 (125 kw)	2012.11-2016.06	MT	R	L	Saloon RWD N13B16A		2050660L	Drive Shaft		28	27		71	743
	2012.11-2016.06	MT	R	R	Saloon RWD N13B16A		2050670L	Drive Shaft		28	27		71	796
2.0 (127 kw)	2005.09-2006.08	MT	R	R	Saloon RWD N45B20A		2051340L	Drive Shaft		30			73	671
2.0 (135 kw)	2012.03-2018.10	6MT	R	L	Saloon RWD N20B20A/N20B20B		2050660L	Drive Shaft		28	27		71	743
	2012.03-2018.10	6MT	R	R	Saloon RWD N20B20A/N20B20B		2050670L	Drive Shaft		28	27		71	796
	2015.07-2018.10	MT	R	L	Saloon RWD B48B20A		2050660L	Drive Shaft		28	27		71	743
	2015.07-2018.10	MT	R	R	Saloon RWD B48B20A		2050670L	Drive Shaft		28	27		71	796
320i Gran Turismo														
2.0 (120 kw)	2013.03-2016.06	MT	R	L	Hatchback RWD N20B20A		2050660L	Drive Shaft		28	27		71	743
	2013.03-2016.06	MT	R	R	Hatchback RWD N20B20A		2050670L	Drive Shaft		28	27		71	796
2.0 (135 kw)	2013.03-2017.05	MT	R	L	Hatchback RWD N20B20A/N20B20B		2050660L	Drive Shaft		28	27		71	743
	2013.03-2017.05	MT	R	R	Hatchback RWD N20B20A/N20B20B		2050670L	Drive Shaft		28	27		71	796
	2016.06-	MT	R	L	Hatchback RWD B48B20A		2050660L	Drive Shaft		28	27		71	743
	2016.06-	MT	R	R	Hatchback RWD B48B20A		2050670L	Drive Shaft		28	27		71	796



		TRANSM.	F/R	L/R	BODY STYLE & DRIVE TYPE & ENGINE	REMARKS	GSP Ref.		Technical Specifications				
									PRODUCT	ABS	A	B	C
BMW													
320i Touring													
2.0 (120 kw)	2012.11-2015.06	AT	R	R	Estate RWD N20B20B	Date From:2013.01	2050670L	Drive Shaft	28	27		71	796
2.0 (135 kw)	2012.11-2015.06	6MT	R	L	Estate RWD N20B20B		2050660L	Drive Shaft	28	27		71	743
	2012.11-2015.06	6MT	R	R	Estate RWD N20B20B		2050670L	Drive Shaft	28	27		71	796
320i xDrive													
2.0 (135 kw)	2012.07-2018.10	8AT/6MT	F	L	Saloon 4WD N20B20A/N20B20B		2020520L	Drive Shaft	31	27	56.8		550
	2012.07-2018.10	8AT/6MT	F	R	Saloon 4WD N20B20A/N20B20B		2020530L	Drive Shaft	31	27	56.8		841
	2012.07-2018.10	MT	R	L	Saloon 4WD N20B20A/N20B20B		2050660L	Drive Shaft	28	27		71	743
	2012.07-2018.10	MT	R	R	Saloon 4WD N20B20A/N20B20B		2050670L	Drive Shaft	28	27		71	796
	2015.07-2018.10	8AT/6MT	F	L	Saloon 4WD B48B20A		2020520L	Drive Shaft	31	27	56.8		550
	2015.07-2018.10	8AT/6MT	F	R	Saloon 4WD B48B20A		2020530L	Drive Shaft	31	27	56.8		841
	2015.07-2018.10	MT	R	L	Saloon 4WD B48B20A		2050660L	Drive Shaft	28	27		71	743
	2015.07-2018.10	MT	R	R	Saloon 4WD B48B20A		2050670L	Drive Shaft	28	27		71	796
320i xDrive Gran Turismo													
2.0 (120 kw)	2013.07-2016.06	AT/MT	F	L	Hatchback 4WD N20B20A		2020520L	Drive Shaft	31	27	56.8		550
	2013.07-2016.06	AT/MT	F	R	Hatchback 4WD N20B20A		2020530L	Drive Shaft	31	27	56.8		841
	2013.07-2016.06	MT	R	L	Hatchback 4WD N20B20A		2050660L	Drive Shaft	28	27		71	743
	2013.07-2016.06	MT	R	R	Hatchback 4WD N20B20A		2050670L	Drive Shaft	28	27		71	796
2.0 (135 kw)	2013.07-2016.06	MT	R	L	Hatchback 4WD N20B20A		2050660L	Drive Shaft	28	27		71	743
	2013.07-2016.06	MT	R	R	Hatchback 4WD N20B20A		2050670L	Drive Shaft	28	27		71	796
320i xDrive Touring													
2.0 (120 kw)	2013.03-2015.06	8AT/6MT	F	L	Estate 4WD N20B20B		2020520L	Drive Shaft	31	27	56.8		550
	2013.03-2015.06	8AT/6MT	F	R	Estate 4WD N20B20B		2020530L	Drive Shaft	31	27	56.8		841
	2013.03-2015.06	6MT	R	L	Estate 4WD N20B20B		2050660L	Drive Shaft	28	27		71	743
	2013.03-2015.06	6MT	R	R	Estate 4WD N20B20B		2050670L	Drive Shaft	28	27		71	796
2.0 (135 kw)	2013.03-2015.06	8AT/6MT	F	L	Estate 4WD N20B20B		2020520L	Drive Shaft	31	27	56.8		550
	2013.03-2015.06	8AT/6MT	F	R	Estate 4WD N20B20B		2020530L	Drive Shaft	31	27	56.8		841
	2013.03-2015.06	6MT	R	L	Estate 4WD N20B20B		2050660L	Drive Shaft	28	27		71	743
	2013.03-2015.06	6MT	R	R	Estate 4WD N20B20B		2050670L	Drive Shaft	28	27		71	796
	2015.07-2019.06	8AT/6MT	F	L	Estate 4WD B48B20A		2020520L	Drive Shaft	31	27	56.8		550
	2015.07-2019.06	8AT/6MT	F	R	Estate 4WD B48B20A		2020530L	Drive Shaft	31	27	56.8		841
	2015.07-2019.06	MT	R	L	Estate 4WD B48B20A		2050660L	Drive Shaft	28	27		71	743
	2015.07-2019.06	MT	R	R	Estate 4WD B48B20A		2050670L	Drive Shaft	28	27		71	796
325d													
3.0 (145 kw)	2006.09-2010.02	AT	R	R	Saloon RWD M57D306D3		2051340L	Drive Shaft	30			73	671
325d Cabrio													
3.0 (145 kw)	2007.07-2010.02	AT	R	R	Cabriolet RWD M57D306D3		2051340L	Drive Shaft	30			73	671
3.0 (155 kw)	2007.01-2009.12	AT/MT	R	R	Cabriolet RWD M57D306D3		2051340L	Drive Shaft	30			73	671
325d Coupe													
3.0 (145 kw)	2006.09-2010.03	AT/MT	R	R	Coupe RWD M57D306D3		2051340L	Drive Shaft	30			73	671
325d Touring													
3.0 (145 kw)	2006.09-2012.06	AT	R	R	Estate RWD M57D306D3		2051340L	Drive Shaft	30			73	671
325i													
2.5 (155 kw)	2006.01-2007.06	6AT/6MT	R	R	Saloon RWD N52B25A	For increased payload	2051340L	Drive Shaft	30			73	671
2.5 (160 kw)	2004.12-2011.12	6AT/6MT	R	R	Saloon RWD N52B25A/N52B25B/N52B25BF	For increased payload	2051340L	Drive Shaft	30			73	671
	2005.09-2008.08	MT	R	R	Saloon 4WD N52B25A		2051340L	Drive Shaft	30			73	671
3.0 (155 kw)	2006.06-2011.12	6AT/6MT	R	R	Saloon RWD N53B30A	For increased payload	2051340L	Drive Shaft	30			73	671
3.0 (160 kw)	2005.09-2008.08	AT/MT	R	R	Saloon 4WD N52B30A/N53B30A		2051340L	Drive Shaft	30			73	671
	2007.06-2011.12	6AT/6MT	R	R	Saloon RWD N53B30A	For increased payload	2051340L	Drive Shaft	30			73	671
325i Cabrio													
2.5 (160 kw)	2006.12-2010.02	6AT/6MT	R	R	Cabriolet RWD N52B25A		2051340L	Drive Shaft	30			73	671
3.0 (155 kw)	2006.10-2013.12	6AT/6MT	R	R	Cabriolet RWD N53B30A		2051340L	Drive Shaft	30			73	671
3.0 (160 kw)	2007.03-2013.12	6AT/6MT	R	R	Cabriolet RWD N53B30A		2051340L	Drive Shaft	30			73	671
325i Coupe													
2.5 (160 kw)	2006.09-2010.02	MT	R	R	Coupe 4WD N52B25A		2051340L	Drive Shaft	30			73	671
3.0 (155 kw)	2007.09-2008.08	AT/MT	R	R	Coupe 4WD N53B30A		2051340L	Drive Shaft	30			73	671
3.0 (160 kw)	2007.09-2010.02	AT/MT	R	R	Coupe 4WD N53B30A		2051340L	Drive Shaft	30			73	671
325i Touring													
2.5 (155 kw)	2005.11-2010.12	6AT/6MT	R	R	Estate RWD N52B25A/N52B25AF		2051340L	Drive Shaft	30			73	671
2.5 (160 kw)	2004.12-2008.08	6AT/6MT	R	R	Estate RWD N52B25A		2051340L	Drive Shaft	30			73	671
	2005.08-2008.08	MT	R	R	Estate 4WD N52B25A		2051340L	Drive Shaft	30			73	671
3.0 (155 kw)	2007.06-2012.10	6AT/6MT	R	R	Estate RWD N53B30A		2051340L	Drive Shaft	30			73	671
	2007.09-2008.08	AT/MT	R	R	Estate 4WD N53B30A		2051340L	Drive Shaft	30			73	671
3.0 (160 kw)	2006.01-2008.08	AT/MT	R	R	Estate 4WD N53B30A		2051340L	Drive Shaft	30			73	671
	2007.06-2012.10	6AT/6MT	R	R	Estate RWD N53B30A		2051340L	Drive Shaft	30			73	671



		TRANSM.	F/R	L/R	BODY STYLE & DRIVE TYPE & ENGINE	REMARKS	GSP Ref.		PRODUCT	ABS	Technical Specifications				
											A	B	C	H	L
BMW															
325i xDrive															
3.0 (155 kw)	2008.09-2011.10	AT/MT	R	R	Saloon 4WD N53B30A		2051340L	Drive Shaft		30			73	671	
3.0 (160 kw)	2008.09-2011.10		R	R	Saloon 4WD N53B30A		2051340L	Drive Shaft		30			73	671	
325i xDrive Coupe															
2.5 (150 kw)	2010.03-2013.06	AT/MT	R	R	Coupe 4WD N52B25A		2051340L	Drive Shaft		30			73	671	
2.5 (160 kw)	2006.09-2012.03	MT	R	R	Coupe 4WD N52B25A		2051340L	Drive Shaft		30			73	671	
3.0 (155 kw)	2008.09-2013.06	AT/MT	R	R	Coupe 4WD N53B30A		2051340L	Drive Shaft		30			73	671	
3.0 (160 kw)	2008.09-2013.12		R	R	Coupe 4WD N53B30A		2051340L	Drive Shaft		30			73	671	
325i xDrive Touring															
2.5 (160 kw)	2004.06-2008.08	MT	R	R	Estate 4WD N52B25A		2051340L	Drive Shaft		30			73	671	
3.0 (155 kw)	2008.09-2012.06	AT/MT	R	R	Estate 4WD N53B30A		2051340L	Drive Shaft		30			73	671	
3.0 (160 kw)	2008.09-2012.10		R	R	Estate 4WD N53B30A		2051340L	Drive Shaft		30			73	671	
328i															
2.0 (180 kw)	2011.11-2018.10	MT	R	L	Saloon RWD N20B20A/N26B20A		2050660L	Drive Shaft		28	27		71	743	
	2011.11-2018.10	MT	R	R	Saloon RWD N20B20A/N26B20A		2050670L	Drive Shaft		28	27		71	796	
328i Gran Turismo															
2.0 (180 kw)	2013.03-2016.06	MT	R	L	Hatchback RWD N20B20A		2050660L	Drive Shaft		28	27		71	743	
	2013.03-2016.06	MT	R	R	Hatchback RWD N20B20A		2050670L	Drive Shaft		28	27		71	796	
328i Touring															
2.0 (180 kw)	2012.07-2015.06	MT	R	L	Estate RWD N20B20A		2050660L	Drive Shaft		28	27		71	743	
	2012.07-2015.06	MT	R	R	Estate RWD N20B20A		2050670L	Drive Shaft		28	27		71	796	
328i xDrive															
2.0 (180 kw)	2012.07-2016.08	8AT/6MT	F	L	Saloon 4WD N20B20A		2020520L	Drive Shaft		31	27	56.8		550	
	2012.07-2016.08	8AT/6MT	F	R	Saloon 4WD N20B20A		2020530L	Drive Shaft		31	27	56.8		841	
	2012.07-2016.08	MT	R	L	Saloon 4WD N20B20A		2050660L	Drive Shaft		28	27		71	743	
	2012.07-2016.08	MT	R	R	Saloon 4WD N20B20A		2050670L	Drive Shaft		28	27		71	796	
328i xDrive Gran Turismo															
2.0 (180 kw)	2013.07-2016.06	AT	F	L	Hatchback 4WD N20B20A		2020520L	Drive Shaft		31	27	56.8		550	
	2013.07-2016.06	AT	F	R	Hatchback 4WD N20B20A		2020530L	Drive Shaft		31	27	56.8		841	
	2013.07-2016.06	AT/MT	R	R	Hatchback 4WD N20B20A		2050670L	Drive Shaft		28	27		71	796	
328i xDrive Touring															
2.0 (180 kw)	2013.03-2015.06	8AT/6MT	F	L	Estate 4WD N20B20A		2020520L	Drive Shaft		31	27	56.8		550	
	2013.03-2015.06	8AT/6MT	F	R	Estate 4WD N20B20A		2020530L	Drive Shaft		31	27	56.8		841	
	2013.03-2015.06	MT	R	L	Estate 4WD N20B20A		2050660L	Drive Shaft		28	27		71	743	
	2013.03-2015.06	MT	R	R	Estate 4WD N20B20A		2050670L	Drive Shaft		28	27		71	796	
330d															
3.0 (170 kw)	2005.03-2008.08	AT/MT	R	R	Saloon 4WD M57D306D3		2051340L	Drive Shaft		30			73	671	
330d Coupe															
3.0 (170 kw)	2006.06-2008.08	AT/MT	R	R	Coupe 4WD M57D306D3		2051340L	Drive Shaft		30			73	671	
330d Touring															
3.0 (170 kw)	2005.06-2008.08	AT/MT	R	R	Estate 4WD M57D306D3		2051340L	Drive Shaft		30			73	671	
330d xDrive															
3.0 (180 kw)	2008.09-2011.12	6AT	R	R	Saloon 4WD N57D30A		2051340L	Drive Shaft		30			73	671	
3.0 (190 kw)	2013.03-2018.10	8AT	F	L	Saloon 4WD N57D30A		2020520L	Drive Shaft		31	27	56.8		550	
	2013.03-2018.10	8AT	F	R	Saloon 4WD N57D30A		2020530L	Drive Shaft		31	27	56.8		841	
3.0 (210 kw)	2013.03-2018.10	8AT	F	L	Saloon 4WD N57D30A		2020520L	Drive Shaft		31	27	56.8		550	
	2013.03-2018.10	8AT	F	R	Saloon 4WD N57D30A		2020530L	Drive Shaft		31	27	56.8		841	
330d xDrive Coupe															
3.0 (180 kw)	2008.09-	6AT	R	R	Coupe 4WD N57D30A		2051340L	Drive Shaft		30			73	671	
330d xDrive Gran Turismo															
3.0 (190 kw)	2014.03-	AT	F	L	Hatchback 4WD N57D30A		2020520L	Drive Shaft		31	27	56.8		550	
	2014.03-	AT	F	R	Hatchback 4WD N57D30A		2020530L	Drive Shaft		31	27	56.8		841	
3.0 (210 kw)	2014.03-	AT	F	L	Hatchback 4WD N57D30A		2020520L	Drive Shaft		31	27	56.8		550	
	2014.03-	AT	F	R	Hatchback 4WD N57D30A		2020530L	Drive Shaft		31	27	56.8		841	
330d xDrive Touring															
3.0 (180 kw)	2008.09-2012.10	6AT	R	R	Estate 4WD N57D30A		2051340L	Drive Shaft		30			73	671	
3.0 (190 kw)	2013.03-2019.06	8AT	F	L	Combi Van 4WD N57D30A		2020520L	Drive Shaft		31	27	56.8		550	
	2013.03-2019.06	8AT	F	R	Combi Van 4WD N57D30A		2020530L	Drive Shaft		31	27	56.8		841	
	2013.03-2019.06	8AT	F	L	Estate 4WD N57D30A		2020520L	Drive Shaft		31	27	56.8		550	
	2013.03-2019.06	8AT	F	R	Estate 4WD N57D30A		2020530L	Drive Shaft		31	27	56.8		841	
3.0 (210 kw)	2013.03-2019.06	8AT	F	L	Estate 4WD N57D30A		2020520L	Drive Shaft		31	27	56.8		550	
	2013.03-2019.06	8AT	F	R	Estate 4WD N57D30A		2020530L	Drive Shaft		31	27	56.8		841	
330e															
2.0 (135 kw)	2015.11-2018.10	AT/8AT	R	L	Saloon RWD B48B20A		2050660L	Drive Shaft		28	27		71	743	
	2015.11-2018.10	AT/8AT	R	R	Saloon RWD B48B20A		2050670L	Drive Shaft		28	27		71	796	



	 YEAR	TRANSM.	F/R	L/R	BODY STYLE & DRIVE TYPE & ENGINE	REMARKS	GSP Ref.	 PRODUCT	 ABS	Technical Specifications				
										A	B	C	H	L
BMW 330i														
2.0 (185 kw)	2015.07-2018.10	MT	R	L	Saloon RWD B46B20B/B48B20B		205066OL	Drive Shaft		28	27		71	743
	2015.07-2018.10	MT	R	R	Saloon RWD B46B20B/B48B20B		205067OL	Drive Shaft		28	27		71	796
3.0 (190 kw)	2004.12-2011.10	MT	R	R	Saloon RWD N52B30A/N52B30BF		205134OL	Drive Shaft		30			73	671
	2005.10-2007.06	MT	R	R	Saloon 4WD N52B30A		205134OL	Drive Shaft		30			73	671
3.0 (200 kw)	2007.03-2008.08	AT/MT	R	R	Saloon 4WD N53B30A		205134OL	Drive Shaft		30			73	671
	2007.03-2011.12	AT/MT	R	R	Saloon RWD N52B30A/N52B30BF/N53B30A		205134OL	Drive Shaft		30			73	671
330i Cabrio														
3.0 (190 kw)	2010.03-2013.10	AT/MT	R	R	Cabriolet RWD N52B30A		205134OL	Drive Shaft		30			73	671
330i Coupe														
3.0 (190 kw)	2006.09-2008.09	AT/MT	R	R	Coupe 4WD N52B30A		205134OL	Drive Shaft		30			73	671
	2010.03-2013.06	AT/MT	R	R	Coupe RWD N52B30A		205134OL	Drive Shaft		30			73	671
330i Touring														
2.0 (185 kw)	2015.07-2019.06	6MT	R	L	Combi Van RWD B48B20B		205066OL	Drive Shaft		28	27		71	743
	2015.07-2019.06	6MT	R	R	Combi Van RWD B48B20B		205067OL	Drive Shaft		28	27		71	796
	2015.07-2019.06	MT	R	L	Estate RWD B48B20B		205066OL	Drive Shaft		28	27		71	743
	2015.07-2019.06	MT	R	R	Estate RWD B48B20B		205067OL	Drive Shaft		28	27		71	796
3.0 (190 kw)	2005.09-2007.08	MT	R	R	Estate RWD N52B30A		205134OL	Drive Shaft		30			73	671
	2005.10-2007.08	MT	R	R	Estate 4WD N52B30A		205134OL	Drive Shaft		30			73	671
3.0 (200 kw)	2007.03-2012.06	AT/MT	R	R	Estate RWD N52B30A/N53B30A		205134OL	Drive Shaft		30			73	671
	2007.09-2012.10	AT/MT	R	R	Estate 4WD N53B30A		205134OL	Drive Shaft		30			73	671
330i xDrive														
2.0 (185 kw)	2015.07-2018.10	8AT	F	L	Saloon 4WD B48B20B		202052OL	Drive Shaft		31	27	56.8		550
	2015.07-2018.10	8AT	F	R	Saloon 4WD B48B20B		202053OL	Drive Shaft		31	27	56.8		841
3.0 (200 kw)	2008.09-2011.12		R	R	Saloon 4WD N53B30A		205134OL	Drive Shaft		30			73	671
330i xDrive Gran Turismo														
2.0 (183 kw)	2016.07-	8AT	F	L	Hatchback 4WD B48B20B		202052OL	Drive Shaft		31	27	56.8		550
	2016.07-	8AT	F	R	Hatchback 4WD B48B20B		202053OL	Drive Shaft		31	27	56.8		841
2.0 (185 kw)	2016.07-	8AT	F	L	Hatchback 4WD B48B20B		202052OL	Drive Shaft		31	27	56.8		550
	2016.07-	8AT	F	R	Hatchback 4WD B48B20B		202053OL	Drive Shaft		31	27	56.8		841
330i xDrive Touring														
2.0 (185 kw)	2015.07-2019.06	8AT	F	L	Estate 4WD B48B20B		202052OL	Drive Shaft		31	27	56.8		550
	2015.07-2019.06	8AT	F	R	Estate 4WD B48B20B		202053OL	Drive Shaft		31	27	56.8		841
3.0 (200 kw)	2007.09-2012.06		R	R	Estate 4WD N53B30A		205134OL	Drive Shaft		30			73	671
335d xDrive														
3.0 (230 kw)	2013.07-2018.10	8AT	F	L	Saloon 4WD N57D30B		202052OL	Drive Shaft		31	27	56.8		550
	2013.07-2018.10	8AT	F	R	Saloon 4WD N57D30B		202053OL	Drive Shaft		31	27	56.8		841
335d xDrive Gran Turismo														
3.0 (230 kw)	2014.03-	AT	F	L	Hatchback 4WD N57D30B		202052OL	Drive Shaft		31	27	56.8		550
	2014.03-	AT	F	R	Hatchback 4WD N57D30B		202053OL	Drive Shaft		31	27	56.8		841
335d xDrive Touring														
3.0 (230 kw)	2013.11-2019.06	8AT	F	L	Estate 4WD N57D30B		202052OL	Drive Shaft		31	27	56.8		550
	2013.11-2019.06	8AT	F	R	Estate 4WD N57D30B		202053OL	Drive Shaft		31	27	56.8		841
335i														
3.0 (225 kw)	2006.09-2011.12	6AT	R	R	Saloon RWD N54B30A/N55B30A		205134OL	Drive Shaft		30			73	671
	2007.03-2008.08	6AT	R	R	Saloon 4WD N54B30A	Date from:2007.10	205134OL	Drive Shaft		30			73	671
	2011.11-2015.07	AT	R	L	Saloon RWD N55B30A		205066OL	Drive Shaft		28	27		71	743
	2011.11-2015.07	AT	R	R	Saloon RWD N55B30A		205067OL	Drive Shaft		28	27		71	796
3.0 (240 kw)	2011.11-2013.06	AT	R	L	Saloon RWD N55B30A		205066OL	Drive Shaft		28	27		71	743
	2011.11-2013.06	AT	R	R	Saloon RWD N55B30A		205067OL	Drive Shaft		28	27		71	796
3.0 (250 kw)	2013.07-2015.07	AT	R	L	Saloon RWD N55B30A		205066OL	Drive Shaft		28	27		71	743
	2013.07-2015.07	AT	R	R	Saloon RWD N55B30A		205067OL	Drive Shaft		28	27		71	796
335i Cabrio														
3.0 (225 kw)	2006.12-2013.10	6AT	R	R	Cabriolet RWD N54B30A/N55B30A	Date From:2007.10	205134OL	Drive Shaft		30			73	671
3.0 (240 kw)	2006.06-2013.10	6AT	R	R	Cabriolet RWD N54B30A/N55B30A		205134OL	Drive Shaft		30			73	671
335i Coupe														
3.0 (225 kw)	2006.06-2013.06	6AT	R	R	Coupe RWD N54B30A/N55B30A	Date From:2007.10	205134OL	Drive Shaft		30			73	671
	2007.06-2008.12	CVT	R	R	Coupe 4WD N54B30A		205134OL	Drive Shaft		30			73	671
3.0 (240 kw)	2006.06-2013.06	6AT	R	R	Coupe RWD N54B30A/N55B30A		205134OL	Drive Shaft		30			73	671
335i Gran Turismo														
3.0 (225 kw)	2013.03-2016.06	AT	R	L	Hatchback RWD N55B30A		205066OL	Drive Shaft		28	27		71	743
	2013.03-2016.06	AT	R	R	Hatchback RWD N55B30A		205067OL	Drive Shaft		28	27		71	796
3.0 (240 kw)	2013.03-2014.03	AT	R	L	Hatchback RWD N55B30A		205066OL	Drive Shaft		28	27		71	743
	2013.03-2014.03	AT	R	R	Hatchback RWD N55B30A		205067OL	Drive Shaft		28	27		71	796
3.0 (250 kw)	2014.04-2016.06	AT	R	L	Hatchback RWD N55B30A		205066OL	Drive Shaft		28	27		71	743
	2014.04-2016.06	AT	R	R	Hatchback RWD N55B30A		205067OL	Drive Shaft		28	27		71	796





	 YEAR	TRANSM.	F/R	L/R	BODY STYLE & DRIVE TYPE & ENGINE	REMARKS	GSP Ref.	 PRODUCT ABS	Technical Specifications				
									A	B	C	H	L
BMW													
335i Touring													
3.0 (225 kw)	2006.09-2012.06	6AT	R	R	Estate RWD N54B30A/N55B30A		2051340L	Drive Shaft	30			73	671
	2007.03-2008.08	6AT	R	R	Estate 4WD N54B30A	Date from:2007.10	2051340L	Drive Shaft	30			73	671
	2013.03-2015.06	AT	R	L	Estate RWD N55B30A		2050660L	Drive Shaft	28	27		71	743
	2013.03-2015.06	AT	R	R	Estate RWD N55B30A		2050670L	Drive Shaft	28	27		71	796
3.0 (240 kw)	2006.09-2008.08	6AT	R	R	Estate 4WD N54B30A	Date from:2007.10	2051340L	Drive Shaft	30			73	671
	2006.09-2012.06	AT/MT	R	R	Estate RWD N54B30A/N55B30A		2051340L	Drive Shaft	30			73	671
	2013.03-2013.06	AT	R	L	Estate RWD N55B30A		2050660L	Drive Shaft	28	27		71	743
	2013.03-2013.06	AT	R	R	Estate RWD N55B30A		2050670L	Drive Shaft	28	27		71	796
3.0 (250 kw)	2013.07-2015.06	AT	R	L	Estate RWD N55B30A		2050660L	Drive Shaft	28	27		71	743
	2013.07-2015.06	AT	R	R	Estate RWD N55B30A		2050670L	Drive Shaft	28	27		71	796
335i xDrive													
3.0 (225 kw)	2008.09-2011.10	6AT	R	R	Saloon 4WD N54B30A/N55B30A	Date from:2007.10	2051340L	Drive Shaft	30			73	671
	2012.07-2015.07	AT/MT	F	R	Saloon 4WD N55B30A		2020530L	Drive Shaft	31	27	56.8		841
	2012.07-2015.07	8AT	R	L	Saloon 4WD N55B30A		2050660L	Drive Shaft	28	27		71	743
	2012.07-2015.07	8AT	R	R	Saloon 4WD N55B30A		2050670L	Drive Shaft	28	27		71	796
3.0 (240 kw)	2006.09-2011.10	6AT	R	R	Saloon 4WD N54B30A/N55B30A	Date from:2007.10	2051340L	Drive Shaft	30			73	671
	2012.07-2013.06	AT	R	L	Saloon 4WD N55B30A		2050660L	Drive Shaft	28	27		71	743
	2012.07-2013.06	AT	R	R	Saloon 4WD N55B30A		2050670L	Drive Shaft	28	27		71	796
3.0 (250 kw)	2012.07-2015.07	AT/MT	R	L	Saloon 4WD N55B30A		2050660L	Drive Shaft	28	27		71	743
	2012.07-2015.07	AT/MT	R	R	Saloon 4WD N55B30A		2050670L	Drive Shaft	28	27		71	796
335i xDrive Coupe													
3.0 (224 kw)	2011.01-	AT/MT	R	R	Coupe 4WD N55B30A		2051340L	Drive Shaft	30			73	671
3.0 (225 kw)	2008.09-	6AT	R	R	Coupe 4WD N54B30A/N55B30A		2051340L	Drive Shaft	30			73	671
3.0 (240 kw)	2007.03-2013.06	AT/MT/6AT	R	R	Coupe 4WD N54B30A/N55B30A		2051340L	Drive Shaft	30			73	671
335i xDrive Gran Turismo													
3.0 (225 kw)	2013.07-2016.06	AT	F	L	Hatchback 4WD N55B30A		2020520L	Drive Shaft	31	27	56.8		550
	2013.07-2016.06	AT	F	R	Hatchback 4WD N55B30A		2020530L	Drive Shaft	31	27	56.8		841
	2013.07-2016.06	AT	R	L	Hatchback 4WD N55B30A		2050660L	Drive Shaft	28	27		71	743
	2013.07-2016.06	AT	R	R	Hatchback 4WD N55B30A		2050670L	Drive Shaft	28	27		71	796
3.0 (240 kw)	2013.03-2014.03	AT	F	L	Hatchback 4WD N55B30A		2020520L	Drive Shaft	31	27	56.8		550
	2013.03-2014.03	AT	F	R	Hatchback 4WD N55B30A		2020530L	Drive Shaft	31	27	56.8		841
	2013.03-2014.03	AT	R	L	Hatchback 4WD N55B30A		2050660L	Drive Shaft	28	27		71	743
	2013.03-2014.03	AT	R	R	Hatchback 4WD N55B30A		2050670L	Drive Shaft	28	27		71	796
3.0 (250 kw)	2014.04-2016.05	AT	F	L	Hatchback 4WD N55B30A		2020520L	Drive Shaft	31	27	56.8		550
	2014.04-2016.05	AT	F	R	Hatchback 4WD N55B30A		2020530L	Drive Shaft	31	27	56.8		841
	2014.04-2016.05	AT	R	L	Hatchback 4WD N55B30A		2050660L	Drive Shaft	28	27		71	743
	2014.04-2016.05	AT	R	R	Hatchback 4WD N55B30A		2050670L	Drive Shaft	28	27		71	796
335i xDrive Touring													
3.0 (225 kw)	2008.09-2012.06	6AT	R	R	Estate 4WD N54B30A/N55B30A		2051340L	Drive Shaft	30			73	671
	2013.03-2015.06	8AT	F	L	Estate 4WD N55B30A		2020520L	Drive Shaft	31	27	56.8		550
	2013.03-2015.06	8AT	F	R	Estate 4WD N55B30A		2020530L	Drive Shaft	31	27	56.8		841
	2013.03-2015.06	AT	R	L	Estate 4WD N55B30A		2050660L	Drive Shaft	28	27		71	743
	2013.03-2015.06	AT	R	R	Estate 4WD N55B30A		2050670L	Drive Shaft	28	27		71	796
3.0 (240 kw)	2008.09-2012.06	AT/MT	R	R	Estate 4WD N54B30A/N55B30A		2051340L	Drive Shaft	30			73	671
	2013.03-2013.06	8AT	F	L	Estate 4WD N55B30A		2020520L	Drive Shaft	31	27	56.8		550
	2013.03-2013.06	8AT	F	R	Estate 4WD N55B30A		2020530L	Drive Shaft	31	27	56.8		841
	2013.03-2013.06	AT	R	L	Estate 4WD N55B30A		2050660L	Drive Shaft	28	27		71	743
	2013.03-2013.06	AT	R	R	Estate 4WD N55B30A		2050670L	Drive Shaft	28	27		71	796
3.0 (250 kw)	2013.07-2015.06	8AT	F	L	Estate 4WD N55B30A		2020520L	Drive Shaft	31	27	56.8		550
	2013.07-2015.06	8AT	F	R	Estate 4WD N55B30A		2020530L	Drive Shaft	31	27	56.8		841
	2013.07-2015.06	AT	R	L	Estate 4WD N55B30A		2050660L	Drive Shaft	28	27		71	743
	2013.07-2015.06	AT	R	R	Estate 4WD N55B30A		2050670L	Drive Shaft	28	27		71	796
340i xDrive													
3.0 (240 kw)	2015.07-2018.10	8AT/6MT	F	L	Saloon 4WD B58B30A		2020520L	Drive Shaft	31	27	56.8		550
	2015.07-2018.10	8AT/6MT	F	R	Saloon 4WD B58B30A		2020530L	Drive Shaft	31	27	56.8		841
	2015.07-2018.10	AT/MT	R	L	Saloon 4WD B58B30A		2050660L	Drive Shaft	28	27		71	743
	2015.07-2018.10	AT/MT	R	R	Saloon 4WD B58B30A		2050670L	Drive Shaft	28	27		71	796
3.0 (265 kw)	2015.07-2018.10	8AT/6MT	F	L	Saloon 4WD B58B30A		2020520L	Drive Shaft	31	27	56.8		550
	2015.07-2018.10	8AT/6MT	F	R	Saloon 4WD B58B30A		2020530L	Drive Shaft	31	27	56.8		841
	2015.07-2018.10	AT/MT	R	L	Saloon 4WD B58B30A		2050660L	Drive Shaft	28	27		71	743
	2015.07-2018.10	AT/MT	R	R	Saloon 4WD B58B30A		2050670L	Drive Shaft	28	27		71	796
340i xDrive Gran Turismo													
3.0 (240 kw)	2016.07-	8AT	F	L	Hatchback 4WD B58B30A		2020520L	Drive Shaft	31	27	56.8		550
	2016.07-	8AT	F	R	Hatchback 4WD B58B30A		2020530L	Drive Shaft	31	27	56.8		841
	2016.07-	8AT	R	R	Hatchback 4WD B58B30A		2050670L	Drive Shaft	28	27		71	796



	 YEAR	TRANSM.	F/R	L/R	BODY STYLE & DRIVE TYPE & ENGINE	REMARKS	GSP Ref.	 PRODUCT	ABS	Technical Specifications									
										A	B	C	H	L					
BMW																			
340i xDrive Gran Turismo																			
3.0 (265 kw)	2016.07-	8AT	F	L	Hatchback 4WD B58B30A		2020520L	Drive Shaft			31	27	56.8						550
	2016.07-	8AT	F	R	Hatchback 4WD B58B30A		2020530L	Drive Shaft			31	27	56.8						841
	2016.07-	8AT	R	R	Hatchback 4WD B58B30A		2050670L	Drive Shaft			28	27							796
340i xDrive Touring																			
3.0 (240 kw)	2015.07-2019.06	8AT	F	L	Estate 4WD B58B30A		2020520L	Drive Shaft			31	27	56.8						550
	2015.07-2019.06	8AT	F	R	Estate 4WD B58B30A		2020530L	Drive Shaft			31	27	56.8						841
	2015.07-2019.06	AT	R	L	Estate 4WD B58B30A		2050660L	Drive Shaft			28	27							743
	2015.07-2019.06	AT	R	R	Estate 4WD B58B30A		2050670L	Drive Shaft			28	27							796
3.0 (265 kw)	2015.07-2019.06	8AT	F	L	Estate 4WD B58B30A		2020520L	Drive Shaft			31	27	56.8						550
	2015.07-2019.06	8AT	F	R	Estate 4WD B58B30A		2020530L	Drive Shaft			31	27	56.8						841
	2015.07-2019.06	AT/MT	R	L	Estate 4WD B58B30A		2050660L	Drive Shaft			28	27							743
	2015.07-2019.06	AT/MT	R	R	Estate 4WD B58B30A		2050670L	Drive Shaft			28	27							796
418d Coupe																			
2.0 (100 kw)	2015.03-2017.10	AT/MT	R	L	Coupe RWD B47D20A		2050660L	Drive Shaft			28	27							743
	2015.03-2017.10	AT/MT	R	R	Coupe RWD B47D20A		2050670L	Drive Shaft			28	27							796
2.0 (110 kw)	2015.03-2017.10	AT/MT	R	L	Coupe RWD B47D20A		2050660L	Drive Shaft			28	27							743
	2015.03-2017.10	AT/MT	R	R	Coupe RWD B47D20A		2050670L	Drive Shaft			28	27							796
418d Gran Coupe																			
2.0 (100 kw)	2014.03-2020.12	8AT/6MT	R	L	Coupe RWD B47D20A/N47D20C		2050660L	Drive Shaft			28	27							743
	2014.03-2020.12	8AT/6MT	R	R	Coupe RWD B47D20A/N47D20C		2050670L	Drive Shaft			28	27							796
2.0 (105 kw)	2014.03-2015.06	AT/MT	R	L	Coupe RWD N47D20C		2050660L	Drive Shaft			28	27							743
	2014.03-2015.06	AT/MT	R	R	Coupe RWD N47D20C		2050670L	Drive Shaft			28	27							796
2.0 (110 kw)	2015.07-	8AT/6MT	R	L	Coupe RWD B47D20A		2050660L	Drive Shaft			28	27							743
	2015.07-	8AT/6MT	R	R	Coupe RWD B47D20A		2050670L	Drive Shaft			28	27							796
418i Coupe																			
1.5 (100 kw)	2016.03-	6MT	R	L	Coupe RWD B38B15A		2050660L	Drive Shaft			28	27							743
	2016.03-	6MT	R	R	Coupe RWD B38B15A		2050670L	Drive Shaft			28	27							796
418i Gran Coupe																			
1.5 (100 kw)	2015.07-	MT	R	L	Coupe RWD B38B15A		2050660L	Drive Shaft			28	27							743
	2015.07-	MT	R	R	Coupe RWD B38B15A		2050670L	Drive Shaft			28	27							796
420d Cabrio																			
2.0 (120 kw)	2013.10-	8AT/6MT	R	L	Cabriolet RWD B47D20A/N47D20C		2050660L	Drive Shaft			28	27							743
	2013.10-	8AT/6MT	R	R	Cabriolet RWD B47D20A/N47D20C		2050670L	Drive Shaft			28	27							796
2.0 (135 kw)	2013.10-2015.06	AT/MT	R	L	Cabriolet RWD N47D20C		2050660L	Drive Shaft			28	27							743
	2013.10-2015.06	AT/MT	R	R	Cabriolet RWD N47D20C		2050670L	Drive Shaft			28	27							796
2.0 (140 kw)	2015.07-	8AT/6MT	R	L	Cabriolet RWD B47D20A		2050660L	Drive Shaft			28	27							743
	2015.07-	8AT/6MT	R	R	Cabriolet RWD B47D20A		2050670L	Drive Shaft			28	27							796
2.0 (147 kw)	2013.10-2015.06	AT/MT	R	L	Cabriolet RWD N47D20C		2050660L	Drive Shaft			28	27							743
	2013.10-2015.06	AT/MT	R	R	Cabriolet RWD N47D20C		2050670L	Drive Shaft			28	27							796
420d Coupe																			
2.0 (120 kw)	2013.07-	8AT/6MT	R	L	Coupe RWD B47D20A/N47D20C		2050660L	Drive Shaft			28	27							743
	2013.07-	8AT/6MT	R	R	Coupe RWD B47D20A/N47D20C		2050670L	Drive Shaft			28	27							796
2.0 (135 kw)	2013.07-2015.02	AT/MT	R	L	Coupe RWD N47D20C		2050660L	Drive Shaft			28	27							743
	2013.07-2015.02	AT/MT	R	R	Coupe RWD N47D20C		2050670L	Drive Shaft			28	27							796
2.0 (140 kw)	2015.03-	AT/MT	R	L	Coupe RWD B47D20A		2050660L	Drive Shaft			28	27							743
	2015.03-	AT/MT	R	R	Coupe RWD B47D20A		2050670L	Drive Shaft			28	27							796
2.0 (147 kw)	2013.07-2015.02	AT/MT	R	L	Coupe RWD N47D20C		2050660L	Drive Shaft			28	27							743
	2013.07-2015.02	AT/MT	R	R	Coupe RWD N47D20C		2050670L	Drive Shaft			28	27							796
420d Gran Coupe																			
2.0 (120 kw)	2014.03-2020.12	8AT/6MT	R	L	Coupe RWD B47D20A/N47D20C		2050660L	Drive Shaft			28	27							743
	2014.03-2020.12	8AT/6MT	R	R	Coupe RWD B47D20A/N47D20C		2050670L	Drive Shaft			28	27							796
2.0 (135 kw)	2014.03-2015.02	AT/MT	R	L	Coupe RWD N47D20C		2050660L	Drive Shaft			28	27							743
	2014.03-2015.02	AT/MT	R	R	Coupe RWD N47D20C		2050670L	Drive Shaft			28	27							796
2.0 (140 kw)	2015.03-	AT/MT	R	L	Coupe RWD B47D20A		2050660L	Drive Shaft			28	27							743
	2015.03-	AT/MT	R	R	Coupe RWD B47D20A		2050670L	Drive Shaft			28	27							796
2.0 (147 kw)	2014.03-2015.02	AT/MT	R	L	Coupe RWD N47D20C		2050660L	Drive Shaft			28	27							743
	2014.03-2015.02	AT/MT	R	R	Coupe RWD N47D20C		2050670L	Drive Shaft			28	27							796
420d xDrive Coupe																			
2.0 (120 kw)	2015.03-	8AT/6MT	F	L	Coupe 4WD B47D20A		2020520L	Drive Shaft			31	27	56.8						550
	2015.03-	8AT/6MT	F	R	Coupe 4WD B47D20A		2020530L	Drive Shaft			31	27	56.8						841
	2015.03-	AT/MT	R	L	Coupe 4WD B47D20A		2050660L	Drive Shaft			28	27							743
	2015.03-	AT/MT	R	R	Coupe 4WD B47D20A		2050670L	Drive Shaft			28	27							796
2.0 (135 kw)	2013.11-2015.02	8AT/6MT	F	L	Coupe 4WD N47D20C		2020520L	Drive Shaft			31	27	56.8						550
	2013.11-2015.02	8AT/6MT	F	R	Coupe 4WD N47D20C		2020530L	Drive Shaft			31	27	56.8						841
	2013.11-2015.02	AT/MT	R	L	Coupe 4WD N47D20C		2050660L	Drive Shaft			28	27							743



		TRANSM.	F/R	L/R	BODY STYLE & DRIVE TYPE & ENGINE	REMARKS	GSP Ref.		ABS	Technical Specifications				
										A	B	C	H	L
BMW														
420d xDrive Coupe														
2.0 (135 kw)	2013.11-2015.02	AT/MT	R	R	Coupe 4WD N47D20C		2050670L	Drive Shaft		28	27		71	796
2.0 (140 kw)	2015.03-	8AT/6MT	F	L	Coupe 4WD B47D20A		2020520L	Drive Shaft		31	27	56.8		550
	2015.03-	8AT/6MT	F	R	Coupe 4WD B47D20A		2020530L	Drive Shaft		31	27	56.8		841
	2015.03-	AT/MT	R	L	Coupe 4WD B47D20A		2050660L	Drive Shaft		28	27		71	743
	2015.03-	AT/MT	R	R	Coupe 4WD B47D20A		2050670L	Drive Shaft		28	27		71	796
	2015.03-	AT/MT	R	R	Coupe 4WD B47D20A		2020520L	Drive Shaft		31	27	56.8		550
2.0 (147 kw)	2013.11-2015.02	8AT/6MT	F	L	Coupe 4WD N47D20C		2020530L	Drive Shaft		31	27	56.8		841
	2013.11-2015.02	8AT/6MT	F	R	Coupe 4WD N47D20C		2050660L	Drive Shaft		28	27		71	743
	2013.11-2015.02	AT/MT	R	L	Coupe 4WD N47D20C		2050670L	Drive Shaft		28	27		71	796
	2013.11-2015.02	AT/MT	R	R	Coupe 4WD N47D20C		2050670L	Drive Shaft		28	27		71	796
420d xDrive Gran Coupe														
2.0 (120 kw)	2014.03-2020.12	8AT/6MT	F	L	Coupe 4WD B47D20A/N47D20C		2020520L	Drive Shaft		31	27	56.8		550
	2014.03-2020.12	8AT/6MT	F	R	Coupe 4WD B47D20A/N47D20C		2020530L	Drive Shaft		31	27	56.8		841
	2014.03-2020.12	8AT/6MT	R	L	Coupe 4WD B47D20A/N47D20C		2050660L	Drive Shaft		28	27		71	743
	2014.03-2020.12	8AT/6MT	R	R	Coupe 4WD B47D20A/N47D20C		2050670L	Drive Shaft		28	27		71	796
2.0 (135 kw)	2014.03-2015.02	8AT/6MT	F	L	Coupe 4WD N47D20C		2020520L	Drive Shaft		31	27	56.8		550
	2014.03-2015.02	8AT/6MT	F	R	Coupe 4WD N47D20C		2020530L	Drive Shaft		31	27	56.8		841
	2014.03-2015.02	AT/MT	R	L	Coupe 4WD N47D20C		2050660L	Drive Shaft		28	27		71	743
	2014.03-2015.02	AT/MT	R	R	Coupe 4WD N47D20C		2050670L	Drive Shaft		28	27		71	796
2.0 (140 kw)	2015.03-	8AT/6MT	F	L	Coupe 4WD B47D20A		2020520L	Drive Shaft		31	27	56.8		550
	2015.03-	8AT/6MT	F	R	Coupe 4WD B47D20A		2020530L	Drive Shaft		31	27	56.8		841
	2015.03-	8AT/6MT	R	L	Coupe 4WD B47D20A		2050660L	Drive Shaft		28	27		71	743
	2015.03-	8AT/6MT	R	R	Coupe 4WD B47D20A		2050670L	Drive Shaft		28	27		71	796
2.0 (147 kw)	2014.03-2015.02	8AT/6MT	F	L	Coupe 4WD N47D20C		2020520L	Drive Shaft		31	27	56.8		550
	2014.03-2015.02	8AT/6MT	F	R	Coupe 4WD N47D20C		2020530L	Drive Shaft		31	27	56.8		841
	2014.03-2015.02	AT/MT	R	L	Coupe 4WD N47D20C		2050660L	Drive Shaft		28	27		71	743
	2014.03-2015.02	AT/MT	R	R	Coupe 4WD N47D20C		2050670L	Drive Shaft		28	27		71	796
420i Cabrio														
2.0 (120 kw)	2014.07-2016.02	MT	R	L	Cabriolet RWD N20B20B		2050660L	Drive Shaft		28	27		71	743
	2014.07-2016.02	MT	R	R	Cabriolet RWD N20B20B		2050670L	Drive Shaft		28	27		71	796
2.0 (135 kw)	2014.07-2016.02	MT	R	L	Cabriolet RWD N20B20B		2050660L	Drive Shaft		28	27		71	743
	2014.07-2016.02	MT	R	R	Cabriolet RWD N20B20B		2050670L	Drive Shaft		28	27		71	796
	2016.03-	MT	R	L	Cabriolet RWD B48B20A		2050660L	Drive Shaft		28	27		71	743
	2016.03-	MT	R	R	Cabriolet RWD B48B20A		2050670L	Drive Shaft		28	27		71	796
420i Coupe														
2.0 (120 kw)	2013.11-2017.02	MT	R	L	Coupe RWD N20B20A/N20B20B		2050660L	Drive Shaft		28	27		71	743
	2013.11-2017.02	MT	R	R	Coupe RWD N20B20A/N20B20B		2050670L	Drive Shaft		28	27		71	796
2.0 (135 kw)	2013.11-2017.02	MT	R	L	Coupe RWD N20B20A/N20B20B		2050660L	Drive Shaft		28	27		71	743
	2013.11-2017.02	MT	R	R	Coupe RWD N20B20A/N20B20B		2050670L	Drive Shaft		28	27		71	796
	2016.03-	MT	R	L	Coupe RWD B48B20A		2050660L	Drive Shaft		28	27		71	743
	2016.03-	MT	R	R	Coupe RWD B48B20A		2050670L	Drive Shaft		28	27		71	796
420i Gran Coupe														
2.0 (120 kw)	2014.03-2017.02	MT	R	L	Coupe RWD N20B20B		2050660L	Drive Shaft		28	27		71	743
	2014.03-2017.02	MT	R	R	Coupe RWD N20B20B		2050670L	Drive Shaft		28	27		71	796
	2016.03-	8AT	R	R	Coupe RWD B48B20A	Not for Facelift,for left-hand drive vehicles;For Facelift	2050670L	Drive Shaft		28	27		71	796
2.0 (135 kw)	2014.03-2017.02	MT	R	L	Coupe RWD N20B20B		2050660L	Drive Shaft		28	27		71	743
	2014.03-2017.02	MT	R	R	Coupe RWD N20B20B		2050670L	Drive Shaft		28	27		71	796
	2016.03-	8AT	R	R	Coupe RWD B48B20A	Not for Facelift,for left-hand drive vehicles;For Facelift	2050670L	Drive Shaft		28	27		71	796
420i xDrive Coupe														
2.0 (120 kw)	2013.11-2016.02	8AT/6MT	F	L	Coupe 4WD N20B20B		2020520L	Drive Shaft		31	27	56.8		550
	2013.11-2016.02	8AT/6MT	F	R	Coupe 4WD N20B20B		2020530L	Drive Shaft		31	27	56.8		841
	2013.11-2016.02	MT	R	L	Coupe 4WD N20B20B		2050660L	Drive Shaft		28	27		71	743
	2013.11-2016.02	MT	R	R	Coupe 4WD N20B20B		2050670L	Drive Shaft		28	27		71	796
	2016.03-	8AT/6MT	F	L	Coupe 4WD B48B20A		2020520L	Drive Shaft		31	27	56.8		550
	2016.03-	8AT/6MT	F	R	Coupe 4WD B48B20A		2020530L	Drive Shaft		31	27	56.8		841
	2016.03-	6MT	R	L	Coupe 4WD B48B20A		2050660L	Drive Shaft		28	27		71	743
	2016.03-	6MT	R	R	Coupe 4WD B48B20A		2050670L	Drive Shaft		28	27		71	796
	2016.03-	6MT	R	R	Coupe 4WD B48B20A		2050670L	Drive Shaft		28	27		71	796
2.0 (135 kw)	2013.11-2016.02	8AT/6MT	F	L	Coupe 4WD N20B20B		2020520L	Drive Shaft		31	27	56.8		550
	2013.11-2016.02	8AT/6MT	F	R	Coupe 4WD N20B20B		2020530L	Drive Shaft		31	27	56.8		841
	2013.11-2016.02	MT	R	L	Coupe 4WD N20B20B		2050660L	Drive Shaft		28	27		71	743
	2013.11-2016.02	MT	R	R	Coupe 4WD N20B20B		2050670L	Drive Shaft		28	27		71	796
	2016.03-	8AT/6MT	F	L	Coupe 4WD B48B20A		2020520L	Drive Shaft		31	27	56.8		550
	2016.03-	8AT/6MT	F	R	Coupe 4WD B48B20A		2020530L	Drive Shaft		31	27	56.8		841
	2016.03-	6MT	R	L	Coupe 4WD B48B20A		2050660L	Drive Shaft		28	27		71	743
	2016.03-	6MT	R	R	Coupe 4WD B48B20A		2050670L	Drive Shaft		28	27		71	796



		TRANSM.	F/R	L/R	BODY STYLE & DRIVE TYPE & ENGINE	REMARKS	GSP Ref.		PRODUCT	ABS	Technical Specifications				
											A	B	C	H	L
BMW															
420i xDrive Gran Coupe															
2.0 (120 kw)	2014.03-2016.02	8AT/6MT	F	L	Coupe 4WD N20B20B		2020520L	Drive Shaft			31	27	56.8		550
	2014.03-2016.02	8AT/6MT	F	R	Coupe 4WD N20B20B		2020530L	Drive Shaft			31	27	56.8		841
	2014.03-2016.02	MT	R	L	Coupe 4WD N20B20B		2050660L	Drive Shaft			28	27		71	743
	2014.03-2016.02	MT	R	R	Coupe 4WD N20B20B		2050670L	Drive Shaft			28	27		71	796
	2016.03-	8AT/6MT	F	L	Coupe 4WD B48B20A		2020520L	Drive Shaft			31	27	56.8		550
	2016.03-	8AT/6MT	F	R	Coupe 4WD B48B20A		2020530L	Drive Shaft			31	27	56.8		841
	2016.03-	6MT	R	L	Coupe 4WD B48B20A		2050660L	Drive Shaft			28	27		71	743
	2016.03-	6MT	R	R	Coupe 4WD B48B20A		2050670L	Drive Shaft			28	27		71	796
2.0 (135 kw)	2014.07-2016.02	8AT/6MT	F	L	Coupe 4WD N20B20B		2020520L	Drive Shaft			31	27	56.8		550
	2014.07-2016.02	8AT/6MT	F	R	Coupe 4WD N20B20B		2020530L	Drive Shaft			31	27	56.8		841
	2014.07-2016.02	MT	R	L	Coupe 4WD N20B20B		2050660L	Drive Shaft			28	27		71	743
	2014.07-2016.02	MT	R	R	Coupe 4WD N20B20B		2050670L	Drive Shaft			28	27		71	796
	2016.03-	8AT/6MT	F	L	Coupe 4WD B48B20A		2020520L	Drive Shaft			31	27	56.8		550
	2016.03-	8AT/6MT	F	R	Coupe 4WD B48B20A		2020530L	Drive Shaft			31	27	56.8		841
	2016.03-	6MT	R	L	Coupe 4WD B48B20A		2050660L	Drive Shaft			28	27		71	743
	2016.03-	6MT	R	R	Coupe 4WD B48B20A		2050670L	Drive Shaft			28	27		71	796
428i Cabrio															
2.0 (180 kw)	2013.11-2017.02	MT	R	L	Cabriolet RWD N20B20A/N26B20A		2050660L	Drive Shaft			28	27		71	743
	2013.11-2017.02	MT	R	R	Cabriolet RWD N20B20A/N26B20A		2050670L	Drive Shaft			28	27		71	796
428i Gran Coupe															
2.0 (180 kw)	2014.03-2016.02	MT	R	L	Coupe RWD N20B20A		2050660L	Drive Shaft			28	27		71	743
	2014.03-2016.02	MT	R	R	Coupe RWD N20B20A		2050670L	Drive Shaft			28	27		71	796
428i xDrive Cabrio															
2.0 (180 kw)	2014.03-2016.02	8AT/6MT	F	L	Cabriolet 4WD N20B20A		2020520L	Drive Shaft			31	27	56.8		550
	2014.03-2016.02	8AT/6MT	F	R	Cabriolet 4WD N20B20A		2020530L	Drive Shaft			31	27	56.8		841
428i xDrive Coupe															
2.0 (180 kw)	2013.07-2016.02	8AT/6MT	F	L	Coupe 4WD N20B20A		2020520L	Drive Shaft			31	27	56.8		550
	2013.07-2016.02	8AT/6MT	F	R	Coupe 4WD N20B20A		2020530L	Drive Shaft			31	27	56.8		841
	2013.07-2016.02	MT	R	L	Coupe 4WD N20B20A		2050660L	Drive Shaft			28	27		71	743
	2013.07-2016.02	MT	R	R	Coupe 4WD N20B20A		2050670L	Drive Shaft			28	27		71	796
428i xDrive Gran Coupe															
2.0 (180 kw)	2014.03-2016.02	8AT/6MT	F	L	Coupe 4WD N20B20A		2020520L	Drive Shaft			31	27	56.8		550
	2014.03-2016.02	8AT/6MT	F	R	Coupe 4WD N20B20A		2020530L	Drive Shaft			31	27	56.8		841
430d xDrive Coupe															
3.0 (190 kw)	2014.03-	8AT	F	L	Coupe 4WD N57D30A		2020520L	Drive Shaft			31	27	56.8		550
	2014.03-	8AT	F	R	Coupe 4WD N57D30A		2020530L	Drive Shaft			31	27	56.8		841
3.0 (210 kw)	2014.03-	8AT	F	L	Coupe 4WD N57D30A		2020520L	Drive Shaft			31	27	56.8		550
	2014.03-	8AT	F	R	Coupe 4WD N57D30A		2020530L	Drive Shaft			31	27	56.8		841
430d xDrive Gran Coupe															
3.0 (190 kw)	2014.07-	8AT	F	L	Coupe 4WD N57D30A		2020520L	Drive Shaft			31	27	56.8		550
	2014.07-	8AT	F	R	Coupe 4WD N57D30A		2020530L	Drive Shaft			31	27	56.8		841
3.0 (210 kw)	2014.07-	8AT	F	L	Coupe 4WD N57D30A		2020520L	Drive Shaft			31	27	56.8		550
	2014.07-	8AT	F	R	Coupe 4WD N57D30A		2020530L	Drive Shaft			31	27	56.8		841
430i Cabrio															
2.0 (185 kw)	2016.03-	6MT	R	L	Cabriolet RWD B48B20B		2050660L	Drive Shaft			28	27		71	743
	2016.03-	6MT	R	R	Cabriolet RWD B48B20B	Diameter:35mm	2050670L	Drive Shaft			28	27		71	796
430i Coupe															
2.0 (183 kw)	2016.03-	6MT	R	L	Coupe RWD B48B20B		2050660L	Drive Shaft			28	27		71	743
	2016.03-	6MT	R	R	Coupe RWD B48B20B		2050670L	Drive Shaft			28	27		71	796
2.0 (185 kw)	2016.03-	6MT	R	L	Coupe RWD B46B20B/B48B20B		2050660L	Drive Shaft			28	27		71	743
	2016.03-	6MT	R	R	Coupe RWD B46B20B/B48B20B		2050670L	Drive Shaft			28	27		71	796
430i Gran Coupe															
2.0 (185 kw)	2016.03-	6MT	R	L	Coupe RWD B48B20B		2050660L	Drive Shaft			28	27		71	743
	2016.03-	6MT	R	R	Coupe RWD B48B20B		2050670L	Drive Shaft			28	27		71	796
430i xDrive Cabrio															
2.0 (185 kw)	2016.03-	8AT	F	L	Cabriolet 4WD B48B20B		2020520L	Drive Shaft			31	27	56.8		550
	2016.03-	8AT	F	R	Cabriolet 4WD B48B20B		2020530L	Drive Shaft			31	27	56.8		841
430i xDrive Coupe															
2.0 (183 kw)	2016.03-	8AT	F	L	Coupe 4WD B48B20B		2020520L	Drive Shaft			31	27	56.8		550
	2016.03-	8AT	F	R	Coupe 4WD B48B20B		2020530L	Drive Shaft			31	27	56.8		841
2.0 (185 kw)	2016.03-	8AT	F	L	Coupe 4WD B48B20B		2020520L	Drive Shaft			31	27	56.8		550
	2016.03-	8AT	F	R	Coupe 4WD B48B20B		2020530L	Drive Shaft			31	27	56.8		841
430i xDrive Gran Coupe															
2.0 (183 kw)	2016.03-	8AT	F	L	Coupe 4WD B48B20B		2020520L	Drive Shaft			31	27	56.8		550
	2016.03-	8AT	F	R	Coupe 4WD B48B20B		2020530L	Drive Shaft			31	27	56.8		841



	 YEAR	TRANSM.	F/R	L/R	BODY STYLE & DRIVE TYPE & ENGINE	REMARKS	GSP Ref.	 PRODUCT	ABS	Technical Specifications				
										A	B	C	H	L
BMW														
430i xDrive Gran Coupe														
2.0 (185 kw)	2016.03-	8AT	F	L	Coupe 4WD B48B20B		2020520L	Drive Shaft		31	27	56.8		550
	2016.03-	8AT	F	R	Coupe 4WD B48B20B		2020530L	Drive Shaft		31	27	56.8		841
435d xDrive Cabrio														
3.0 (230 kw)	2014.07-	8AT	F	L	Cabriolet 4WD N57D30B		2020520L	Drive Shaft		31	27	56.8		550
	2014.07-	8AT	F	R	Cabriolet 4WD N57D30B		2020530L	Drive Shaft		31	27	56.8		841
435d xDrive Coupe														
3.0 (230 kw)	2013.11-	8AT	F	L	Coupe 4WD N57D30B		2020520L	Drive Shaft		31	27	56.8		550
	2013.11-	8AT	F	R	Coupe 4WD N57D30B		2020530L	Drive Shaft		31	27	56.8		841
435d xDrive Gran Coupe														
3.0 (230 kw)	2014.07-	8AT	F	L	Coupe 4WD N57D30B		2020520L	Drive Shaft		31	27	56.8		550
	2014.07-	8AT	F	R	Coupe 4WD N57D30B		2020530L	Drive Shaft		31	27	56.8		841
435i Cabrio														
3.0 (225 kw)	2013.11-2016.02	AT	R	L	Cabriolet RWD N55B30A		2050660L	Drive Shaft		28	27		71	743
	2013.11-2016.02	AT	R	R	Cabriolet RWD N55B30A		2050670L	Drive Shaft		28	27		71	796
3.0 (250 kw)	2013.11-2016.02	AT	R	L	Cabriolet RWD N55B30A		2050660L	Drive Shaft		28	27		71	743
	2013.11-2016.02	AT	R	R	Cabriolet RWD N55B30A		2050670L	Drive Shaft		28	27		71	796
435i Coupe														
3.0 (225 kw)	2013.07-2016.02	8AT	R	L	Coupe RWD N55B30A		2050660L	Drive Shaft		28	27		71	743
	2013.07-2016.02	8AT	R	R	Coupe RWD N55B30A		2050670L	Drive Shaft		28	27		71	796
3.0 (250 kw)	2013.07-2016.02	8AT	R	L	Coupe RWD N55B30A		2050660L	Drive Shaft		28	27		71	743
	2013.07-2016.02	8AT	R	R	Coupe RWD N55B30A		2050670L	Drive Shaft		28	27		71	796
435i Gran Coupe														
3.0 (225 kw)	2014.03-2016.02	AT	R	L	Coupe RWD N55B30A		2050660L	Drive Shaft		28	27		71	743
	2014.03-2016.02	AT	R	R	Coupe RWD N55B30A		2050670L	Drive Shaft		28	27		71	796
3.0 (250 kw)	2014.03-2016.02	AT	R	L	Coupe RWD N55B30A		2050660L	Drive Shaft		28	27		71	743
	2014.03-2016.02	AT	R	R	Coupe RWD N55B30A		2050670L	Drive Shaft		28	27		71	796
435i xDrive Cabrio														
3.0 (225 kw)	2014.07-2016.02	8AT/6MT	F	L	Cabriolet 4WD N55B30A		2020520L	Drive Shaft		31	27	56.8		550
	2014.07-2016.02	8AT/6MT	F	R	Cabriolet 4WD N55B30A		2020530L	Drive Shaft		31	27	56.8		841
	2014.07-2016.02	AT/MT	R	L	Cabriolet 4WD N55B30A		2050660L	Drive Shaft		28	27		71	743
	2014.07-2016.02	AT/MT	R	R	Cabriolet 4WD N55B30A		2050670L	Drive Shaft		28	27		71	796
3.0 (250 kw)	2014.07-2016.02	8AT/6MT	F	L	Cabriolet 4WD N55B30A		2020520L	Drive Shaft		31	27	56.8		550
	2014.07-2016.02	8AT/6MT	F	R	Cabriolet 4WD N55B30A		2020530L	Drive Shaft		31	27	56.8		841
	2014.07-2016.02	AT/MT	R	L	Cabriolet 4WD N55B30A		2050660L	Drive Shaft		28	27		71	743
	2014.07-2016.02	AT/MT	R	R	Cabriolet 4WD N55B30A		2050670L	Drive Shaft		28	27		71	796
435i xDrive Coupe														
3.0 (225 kw)	2013.07-2016.02	8AT/6MT	F	L	Coupe 4WD N55B30A		2020520L	Drive Shaft		31	27	56.8		550
	2013.07-2016.02	8AT/6MT	F	R	Coupe 4WD N55B30A		2020530L	Drive Shaft		31	27	56.8		841
	2013.07-2016.02	AT/MT	R	L	Coupe 4WD N55B30A		2050660L	Drive Shaft		28	27		71	743
	2013.07-2016.02	AT/MT	R	R	Coupe 4WD N55B30A		2050670L	Drive Shaft		28	27		71	796
3.0 (250 kw)	2013.07-2016.02	8AT/6MT	F	L	Coupe 4WD N55B30A		2020520L	Drive Shaft		31	27	56.8		550
	2013.07-2016.02	8AT/6MT	F	R	Coupe 4WD N55B30A		2020530L	Drive Shaft		31	27	56.8		841
	2013.07-2016.02	AT/MT	R	L	Coupe 4WD N55B30A		2050660L	Drive Shaft		28	27		71	743
	2013.07-2016.02	AT/MT	R	R	Coupe 4WD N55B30A		2050670L	Drive Shaft		28	27		71	796
435i xDrive Gran Coupe														
3.0 (225 kw)	2014.07-2016.02	8AT/6MT	F	L	Coupe 4WD N55B30A		2020520L	Drive Shaft		31	27	56.8		550
	2014.07-2016.02	8AT/6MT	F	R	Coupe 4WD N55B30A		2020530L	Drive Shaft		31	27	56.8		841
	2014.07-2016.02	AT/MT	R	L	Coupe 4WD N55B30A		2050660L	Drive Shaft		28	27		71	743
	2014.07-2016.02	AT/MT	R	R	Coupe 4WD N55B30A		2050670L	Drive Shaft		28	27		71	796
3.0 (250 kw)	2014.07-2016.02	8AT/6MT	F	L	Coupe 4WD N55B30A		2020520L	Drive Shaft		31	27	56.8		550
	2014.07-2016.02	8AT/6MT	F	R	Coupe 4WD N55B30A		2020530L	Drive Shaft		31	27	56.8		841
	2014.07-2016.02	AT/MT	R	L	Coupe 4WD N55B30A		2050660L	Drive Shaft		28	27		71	743
	2014.07-2016.02	AT/MT	R	R	Coupe 4WD N55B30A		2050670L	Drive Shaft		28	27		71	796
440i xDrive Cabrio														
3.0 (240 kw)	2016.03-	8AT	F	L	Cabriolet 4WD B58B30A		2020520L	Drive Shaft		31	27	56.8		550
	2016.03-	8AT	F	R	Cabriolet 4WD B58B30A		2020530L	Drive Shaft		31	27	56.8		841
	2016.03-	8AT	R	L	Cabriolet 4WD B58B30A		2050660L	Drive Shaft		28	27		71	743
	2016.03-	8AT	R	R	Cabriolet 4WD B58B30A		2050670L	Drive Shaft		28	27		71	796
3.0 (265 kw)	2016.03-	8AT	F	L	Cabriolet 4WD B58B30A		2020520L	Drive Shaft		31	27	56.8		550
	2016.03-	8AT	F	R	Cabriolet 4WD B58B30A		2020530L	Drive Shaft		31	27	56.8		841
	2016.03-	8AT	R	L	Cabriolet 4WD B58B30A		2050660L	Drive Shaft		28	27		71	743
	2016.03-	8AT	R	R	Cabriolet 4WD B58B30A		2050670L	Drive Shaft		28	27		71	796
440i xDrive Coupe														
3.0 (240 kw)	2016.03-	8AT/6MT	F	L	Coupe 4WD B58B30A		2020520L	Drive Shaft		31	27	56.8		550
	2016.03-	8AT/6MT	F	R	Coupe 4WD B58B30A		2020530L	Drive Shaft		31	27	56.8		841



	 YEAR	TRANSM.	F/R	L/R	BODY STYLE & DRIVE TYPE & ENGINE	REMARKS	GSP Ref.	 PRODUCT	 ABS	Technical Specifications				
										A	B	C	H	L
BMW														
440i xDrive Coupe														
3.0 (240 kw)	2016.03-	6MT	R	L	Coupe 4WD B58B30A		205066OL	Drive Shaft		28	27		71	743
	2016.03-	6MT	R	R	Coupe 4WD B58B30A		205067OL	Drive Shaft		28	27		71	796
3.0 (265 kw)	2016.03-	8AT/6MT	F	L	Coupe 4WD B58B30A		202052OL	Drive Shaft		31	27	56.8		550
	2016.03-	8AT/6MT	F	R	Coupe 4WD B58B30A		202053OL	Drive Shaft		31	27	56.8		841
	2016.03-	6MT	R	L	Coupe 4WD B58B30A		205066OL	Drive Shaft		28	27		71	743
	2016.03-	6MT	R	R	Coupe 4WD B58B30A		205067OL	Drive Shaft		28	27		71	796
440i xDrive Gran Coupe														
3.0 (240 kw)	2016.03-	8AT	F	L	Coupe 4WD B58B30A		202052OL	Drive Shaft		31	27	56.8		550
	2016.03-	8AT	F	R	Coupe 4WD B58B30A		202053OL	Drive Shaft		31	27	56.8		841
	2016.03-	AT	R	L	Coupe 4WD B58B30A		205066OL	Drive Shaft		28	27		71	743
	2016.03-	AT	R	R	Coupe 4WD B58B30A		205067OL	Drive Shaft		28	27		71	796
3.0 (265 kw)	2016.03-	8AT	F	L	Coupe 4WD B58B30A		202052OL	Drive Shaft		31	27	56.8		550
	2016.03-	8AT	F	R	Coupe 4WD B58B30A		202053OL	Drive Shaft		31	27	56.8		841
	2016.03-	8AT	R	L	Coupe 4WD B58B30A		205066OL	Drive Shaft		28	27		71	743
	2016.03-	8AT	R	R	Coupe 4WD B58B30A		205067OL	Drive Shaft		28	27		71	796
5 ActiveHybrid														
3.0 (225 kw)	2011.12-2016.10	8AT	R	L	Saloon RWD N55B30A		205114OL	Drive Shaft		30	27		77	764
	2011.12-2016.10	8AT	R	R	Saloon RWD N55B30A		205115OL	Drive Shaft		30	27		77	818
518d														
2.0 (100 kw)	2013.07-2014.06	6MT	R	L	Saloon RWD N47D20C		205114OL	Drive Shaft		30	27		77	764
	2013.07-2014.06	6MT	R	R	Saloon RWD N47D20C		205115OL	Drive Shaft		30	27		77	818
	2013.07-2014.06	8AT	R	L	Saloon RWD N47D20C		205112OL	Drive Shaft		30	27		77	761
	2013.07-2014.06	8AT	R	R	Saloon RWD N47D20C		205113OL	Drive Shaft		30	27		77	814
2.0 (105 kw)	2013.07-2014.06	6MT	R	L	Saloon RWD N47D20C		205114OL	Drive Shaft		30	27		77	764
	2013.07-2014.06	6MT	R	R	Saloon RWD N47D20C		205115OL	Drive Shaft		30	27		77	818
	2013.07-2014.06	8AT	R	L	Saloon RWD N47D20C		205112OL	Drive Shaft		30	27		77	761
2.0 (110 kw)	2013.07-2014.06	8AT	R	R	Saloon RWD N47D20C		205113OL	Drive Shaft		30	27		77	814
	2014.07-2016.10	6MT	R	L	Saloon RWD B47D20A		205114OL	Drive Shaft		30	27		77	764
	2014.07-2016.10	6MT	R	R	Saloon RWD B47D20A		205115OL	Drive Shaft		30	27		77	818
2.0 (120 kw)	2014.07-2016.10	8AT	R	L	Saloon RWD B47D20A		205112OL	Drive Shaft		30	27		77	761
	2014.07-2016.10	8AT	R	R	Saloon RWD B47D20A		205113OL	Drive Shaft		30	27		77	814
	2013.10-2016.10	6MT	R	L	Saloon RWD B47D20A		205114OL	Drive Shaft		30	27		77	764
	2013.10-2016.10	6MT	R	R	Saloon RWD B47D20A		205115OL	Drive Shaft		30	27		77	818
2.0 (120 kw)	2013.10-2016.10	8AT	R	L	Saloon RWD B47D20A		205112OL	Drive Shaft		30	27		77	761
	2013.10-2016.10	8AT	R	R	Saloon RWD B47D20A		205113OL	Drive Shaft		30	27		77	814
	2013.07-2014.06	6MT	R	L	Estate RWD N47D20C		205114OL	Drive Shaft		30	27		77	764
	2013.07-2014.06	6MT	R	R	Estate RWD N47D20C		205115OL	Drive Shaft		30	27		77	818
2.0 (105 kw)	2013.07-2014.06	8AT	R	L	Estate RWD N47D20C		205112OL	Drive Shaft		30	27		77	761
	2013.07-2014.06	8AT	R	R	Estate RWD N47D20C		205113OL	Drive Shaft		30	27		77	814
	2013.07-2014.06	6MT	R	L	Estate RWD N47D20C		205114OL	Drive Shaft		30	27		77	764
	2013.07-2014.06	6MT	R	R	Estate RWD N47D20C		205115OL	Drive Shaft		30	27		77	818
2.0 (110 kw)	2013.07-2014.06	8AT	R	L	Estate RWD N47D20C		205112OL	Drive Shaft		30	27		77	761
	2013.07-2014.06	8AT	R	R	Estate RWD N47D20C		205113OL	Drive Shaft		30	27		77	814
	2014.07-2017.02	6MT	R	L	Estate RWD B47D20A		205114OL	Drive Shaft		30	27		77	764
	2014.07-2017.02	6MT	R	R	Estate RWD B47D20A		205115OL	Drive Shaft		30	27		77	818
2.0 (120 kw)	2014.07-2017.02	8AT	R	L	Estate RWD B47D20A		205112OL	Drive Shaft		30	27		77	761
	2014.07-2017.02	8AT	R	R	Estate RWD B47D20A		205113OL	Drive Shaft		30	27		77	814
	2014.07-2017.02	6MT	R	L	Estate RWD B47D20A		205114OL	Drive Shaft		30	27		77	764
	2014.07-2017.02	6MT	R	R	Estate RWD B47D20A		205115OL	Drive Shaft		30	27		77	818
2.0 (135 kw)	2014.07-2017.02	8AT	R	L	Estate RWD B47D20A		205112OL	Drive Shaft		30	27		77	761
	2014.07-2017.02	8AT	R	R	Estate RWD B47D20A		205113OL	Drive Shaft		30	27		77	814
	2010.06-2016.10	6MT	R	L	Saloon RWD B47D20A/N47D20C		205114OL	Drive Shaft		30	27		77	764
	2010.06-2016.10	6MT	R	R	Saloon RWD B47D20A/N47D20C		205115OL	Drive Shaft		30	27		77	818
2.0 (120 kw)	2010.06-2016.10	8AT	R	L	Saloon RWD B47D20A/N47D20C	For Engine Code:N47D20C	205112OL	Drive Shaft		30	27		77	761
	2010.06-2016.10	8AT	R	L	Saloon RWD B47D20A/N47D20C	code:B47D20A	205114OL	Drive Shaft		30	27		77	764
	2010.06-2016.10	8AT	R	R	Saloon RWD B47D20A/N47D20C	code:N47D20C	205113OL	Drive Shaft		30	27		77	814
	2010.06-2016.10	8AT	R	R	Saloon RWD B47D20A/N47D20C	For Engine Code:B47D20A	205115OL	Drive Shaft		30	27		77	818
	2010.06-2014.06	6MT	R	L	Saloon RWD N47D20C		205114OL	Drive Shaft		30	27		77	764
	2010.06-2014.06	6MT	R	R	Saloon RWD N47D20C		205115OL	Drive Shaft		30	27		77	818



		TRANSM.	F/R	L/R	BODY STYLE & DRIVE TYPE & ENGINE	REMARKS	GSP Ref.		ABS	Technical Specifications				
										A	B	C	H	L
BMW 520d														
2.0 (135 kw)	2010.06-2014.06	8AT	R	L	Saloon RWD N47D20C		2051120L	Drive Shaft		30	27		77	761
	2010.06-2014.06	8AT	R	R	Saloon RWD N47D20C		2051130L	Drive Shaft		30	27		77	814
2.0 (140 kw)	2014.07-2016.10	8AT/6MT	R	L	Saloon RWD B47D20A	Inner teeth of wheel side:28	2051140L	Drive Shaft		30	27		77	764
	2014.07-2016.10	8AT/6MT	R	R	Saloon RWD B47D20A	Inner teeth of wheel side:28	2051150L	Drive Shaft		30	27		77	818
2.0 (147 kw)	2010.06-2014.06	6MT	R	L	Saloon RWD N47D20C		2051140L	Drive Shaft		30	27		77	764
	2010.06-2014.06	6MT	R	R	Saloon RWD N47D20C		2051150L	Drive Shaft		30	27		77	818
	2010.06-2014.06	8AT	R	L	Saloon RWD N47D20C		2051120L	Drive Shaft		30	27		77	761
	2010.06-2014.06	8AT	R	R	Saloon RWD N47D20C		2051130L	Drive Shaft		30	27		77	814
2.0 (151 kw)	2014.07-2016.10	8AT/6MT	R	L	Saloon RWD B47D20A		2051140L	Drive Shaft		30	27		77	764
	2014.07-2016.10	8AT/6MT	R	R	Saloon RWD B47D20A		2051150L	Drive Shaft		30	27		77	818
	2014.07-2016.10	AT	R	L	Saloon RWD B47D20A	Date From:2015.01	2051120L	Drive Shaft		30	27		77	761
	2014.07-2016.10	AT	R	R	Saloon RWD B47D20A	Date From:2015.01	2051130L	Drive Shaft		30	27		77	814
2.0 (155 kw)	2013.10-2016.10	8AT/6MT	R	L	Saloon RWD B47D20A		2051140L	Drive Shaft		30	27		77	764
	2013.10-2016.10	8AT/6MT	R	R	Saloon RWD B47D20A		2051150L	Drive Shaft		30	27		77	818
	2013.10-2016.10	AT	R	L	Saloon RWD B47D20A	Date From:2014.01	2051120L	Drive Shaft		30	27		77	761
	2013.10-2016.10	AT	R	R	Saloon RWD B47D20A	Date From:2014.01	2051130L	Drive Shaft		30	27		77	814
520d Touring														
2.0 (100 kw)	2010.06-2014.06	6MT	R	L	Estate RWD N47D20C		2051140L	Drive Shaft		30	27		77	764
	2010.06-2014.06	6MT	R	R	Estate RWD N47D20C		2051150L	Drive Shaft		30	27		77	818
	2010.06-2014.06	8AT	R	L	Estate RWD N47D20C		2051120L	Drive Shaft		30	27		77	761
	2010.06-2014.06	8AT	R	R	Estate RWD N47D20C		2051130L	Drive Shaft		30	27		77	814
2.0 (120 kw)	2010.06-2017.02	6MT	R	L	Estate RWD B47D20A/N47D20C		2051140L	Drive Shaft		30	27		77	764
	2010.06-2017.02	6MT	R	R	Estate RWD B47D20A/N47D20C		2051150L	Drive Shaft		30	27		77	818
	2010.06-2017.02	8AT	R	L	Estate RWD B47D20A/N47D20C	For Engine Code:N47D20C	2051120L	Drive Shaft		30	27		77	761
	2010.06-2017.02	8AT	R	L	Estate RWD B47D20A/N47D20C	code:B47D20A	2051140L	Drive Shaft		30	27		77	764
	2010.06-2017.02	8AT	R	R	Estate RWD B47D20A/N47D20C	code:N47D20C	2051130L	Drive Shaft		30	27		77	814
	2010.06-2017.02	8AT	R	R	Estate RWD B47D20A/N47D20C	For Engine Code:B47D20A	2051150L	Drive Shaft		30	27		77	818
2.0 (135 kw)	2010.06-2014.06	6MT	R	L	Estate RWD N47D20C		2051140L	Drive Shaft		30	27		77	764
	2010.06-2014.06	6MT	R	R	Estate RWD N47D20C		2051150L	Drive Shaft		30	27		77	818
	2010.06-2014.06	8AT	R	L	Estate RWD N47D20C		2051120L	Drive Shaft		30	27		77	761
	2010.06-2014.06	8AT	R	R	Estate RWD N47D20C		2051130L	Drive Shaft		30	27		77	814
2.0 (140 kw)	2014.07-2017.02	8AT/6MT	R	L	Estate RWD B47D20A		2051140L	Drive Shaft		30	27		77	764
	2014.07-2017.02	8AT/6MT	R	R	Estate RWD B47D20A		2051150L	Drive Shaft		30	27		77	818
2.0 (147 kw)	2010.06-2014.06	6MT	R	L	Estate RWD N47D20C		2051140L	Drive Shaft		30	27		77	764
	2010.06-2014.06	6MT	R	R	Estate RWD N47D20C		2051150L	Drive Shaft		30	27		77	818
	2010.06-2014.06	8AT	R	L	Estate RWD N47D20C		2051120L	Drive Shaft		30	27		77	761
	2010.06-2014.06	8AT	R	R	Estate RWD N47D20C		2051130L	Drive Shaft		30	27		77	814
2.0 (151 kw)	2014.07-2017.02	8AT/6MT	R	L	Estate RWD B47D20A		2051140L	Drive Shaft		30	27		77	764
	2014.07-2017.02	8AT/6MT	R	R	Estate RWD B47D20A		2051150L	Drive Shaft		30	27		77	818
	2014.07-2017.02	AT	R	L	Estate RWD B47D20A	Date From:2015.01	2051120L	Drive Shaft		30	27		77	761
	2014.07-2017.02	AT	R	R	Estate RWD B47D20A	Date From:2015.01	2051130L	Drive Shaft		30	27		77	814
2.0 (155 kw)	2014.07-2017.02	8AT/6MT	R	L	Estate RWD B47D20A		2051140L	Drive Shaft		30	27		77	764
	2014.07-2017.02	8AT/6MT	R	R	Estate RWD B47D20A		2051150L	Drive Shaft		30	27		77	818
	2014.07-2017.02	AT	R	L	Estate RWD B47D20A	Date From:2015.01	2051120L	Drive Shaft		30	27		77	761
	2014.07-2017.02	AT	R	R	Estate RWD B47D20A	Date From:2015.01	2051130L	Drive Shaft		30	27		77	814
520d xDrive														
2.0 (100 kw)	2013.01-2014.06	8AT	F	L	Saloon 4WD N47D20C		2015810L	Drive Shaft		37	27	65		562
	2013.01-2014.06	8AT	F	R	Saloon 4WD N47D20C		2016810L	Drive Shaft		37	27	65		864
	2013.01-2014.06	8AT	R	L	Saloon 4WD N47D20C		2051120L	Drive Shaft		30	27		77	761
	2013.01-2014.06	8AT	R	R	Saloon 4WD N47D20C		2051130L	Drive Shaft		30	27		77	814
2.0 (120 kw)	2013.10-2016.10	8AT	F	L	Saloon 4WD B47D20A		2015810L	Drive Shaft		37	27	65		562
	2013.10-2016.10	8AT	F	R	Saloon 4WD B47D20A		2016810L	Drive Shaft		37	27	65		864
	2013.10-2016.10	8AT	R	L	Saloon 4WD B47D20A		2051120L	Drive Shaft		30	27		77	761
	2013.10-2016.10	8AT	R	R	Saloon 4WD B47D20A		2051130L	Drive Shaft		30	27		77	814
2.0 (135 kw)	2013.07-2014.06	8AT	F	L	Saloon 4WD N47D20C		2015810L	Drive Shaft		37	27	65		562
	2013.07-2014.06	8AT	F	R	Saloon 4WD N47D20C		2016810L	Drive Shaft		37	27	65		864
	2013.07-2014.06	8AT	R	L	Saloon 4WD N47D20C		2051120L	Drive Shaft		30	27		77	761
	2013.07-2014.06	8AT	R	R	Saloon 4WD N47D20C		2051130L	Drive Shaft		30	27		77	814
2.0 (140 kw)	2014.07-2016.10	8AT	F	L	Saloon 4WD B47D20A		2015810L	Drive Shaft		37	27	65		562
	2014.07-2016.10	8AT	F	R	Saloon 4WD B47D20A		2016810L	Drive Shaft		37	27	65		864
	2014.07-2016.10	8AT	R	L	Saloon 4WD B47D20A		2051120L	Drive Shaft		30	27		77	761
	2014.07-2016.10	8AT	R	R	Saloon 4WD B47D20A		2051130L	Drive Shaft		30	27		77	814
2.0 (147 kw)	2013.01-2014.06	8AT	F	L	Saloon 4WD N47D20C		2015810L	Drive Shaft		37	27	65		562
	2013.01-2014.06	8AT	F	R	Saloon 4WD N47D20C		2016810L	Drive Shaft		37	27	65		864
	2013.01-2014.06	8AT	R	L	Saloon 4WD N47D20C		2051120L	Drive Shaft		30	27		77	761



	 YEAR	TRANSM.	F/R	L/R	BODY STYLE & DRIVE TYPE & ENGINE	REMARKS	GSP Ref.	 PRODUCT ABS	Technical Specifications									
									A	B	C	H	L					
BMW																		
520d xDrive																		
2.0 (147 kw)	2013.01-2014.06	8AT	R	R	Saloon 4WD N47D20C		2051130L	Drive Shaft	30	27		77	814					
2.0 (151 kw)	2014.07-2016.10	8AT	F	L	Saloon 4WD B47D20A		2015810L	Drive Shaft	37	27	65		562					
	2014.07-2016.10	8AT	F	R	Saloon 4WD B47D20A		2016810L	Drive Shaft	37	27	65		864					
	2014.07-2016.10	8AT	R	L	Saloon 4WD B47D20A		2051120L	Drive Shaft	30	27		77	761					
	2014.07-2016.10	8AT	R	R	Saloon 4WD B47D20A		2051130L	Drive Shaft	30	27		77	814					
2.0 (155 kw)	2013.10-2016.10	8AT	F	L	Saloon 4WD B47D20A		2015810L	Drive Shaft	37	27	65		562					
	2013.10-2016.10	8AT	F	R	Saloon 4WD B47D20A		2016810L	Drive Shaft	37	27	65		864					
	2013.10-2016.10	8AT	R	L	Saloon 4WD B47D20A		2051120L	Drive Shaft	30	27		77	761					
	2013.10-2016.10	8AT	R	R	Saloon 4WD B47D20A		2051130L	Drive Shaft	30	27		77	814					
520d xDrive Touring																		
2.0 (100 kw)	2013.07-2014.06	8AT	F	L	Estate 4WD N47D20C		2015810L	Drive Shaft	37	27	65		562					
	2013.07-2014.06	8AT	F	R	Estate 4WD N47D20C		2016810L	Drive Shaft	37	27	65		864					
	2013.07-2014.06	8AT	R	L	Estate 4WD N47D20C		2051120L	Drive Shaft	30	27		77	761					
	2013.07-2014.06	8AT	R	R	Estate 4WD N47D20C		2051130L	Drive Shaft	30	27		77	814					
2.0 (120 kw)	2014.07-2017.02	8AT	F	L	Estate 4WD B47D20A		2015810L	Drive Shaft	37	27	65		562					
	2014.07-2017.02	8AT	F	R	Estate 4WD B47D20A		2016810L	Drive Shaft	37	27	65		864					
	2014.07-2017.02	8AT	R	L	Estate 4WD B47D20A		2051120L	Drive Shaft	30	27		77	761					
	2014.07-2017.02	8AT	R	R	Estate 4WD B47D20A		2051130L	Drive Shaft	30	27		77	814					
2.0 (135 kw)	2013.07-2014.06	8AT	F	L	Estate 4WD N47D20C		2015810L	Drive Shaft	37	27	65		562					
	2013.07-2014.06	8AT	F	R	Estate 4WD N47D20C		2016810L	Drive Shaft	37	27	65		864					
	2013.07-2014.06	8AT	R	L	Estate 4WD N47D20C		2051120L	Drive Shaft	30	27		77	761					
	2013.07-2014.06	8AT	R	R	Estate 4WD N47D20C		2051130L	Drive Shaft	30	27		77	814					
2.0 (140 kw)	2014.07-2017.02	8AT	F	L	Estate 4WD B47D20A		2015810L	Drive Shaft	37	27	65		562					
	2014.07-2017.02	8AT	F	R	Estate 4WD B47D20A		2016810L	Drive Shaft	37	27	65		864					
	2014.07-2017.02	8AT	R	L	Estate 4WD B47D20A		2051120L	Drive Shaft	30	27		77	761					
	2014.07-2017.02	8AT	R	R	Estate 4WD B47D20A		2051130L	Drive Shaft	30	27		77	814					
2.0 (147 kw)	2013.07-2014.06	8AT	F	L	Estate 4WD N47D20C		2015810L	Drive Shaft	37	27	65		562					
	2013.07-2014.06	8AT	F	R	Estate 4WD N47D20C		2016810L	Drive Shaft	37	27	65		864					
	2013.07-2014.06	8AT	R	L	Estate 4WD N47D20C		2051120L	Drive Shaft	30	27		77	761					
	2013.07-2014.06	8AT	R	R	Estate 4WD N47D20C		2051130L	Drive Shaft	30	27		77	814					
2.0 (151 kw)	2014.07-2017.02	8AT	F	L	Estate 4WD B47D20A		2015810L	Drive Shaft	37	27	65		562					
	2014.07-2017.02	8AT	F	R	Estate 4WD B47D20A		2016810L	Drive Shaft	37	27	65		864					
	2014.07-2017.02	8AT	R	L	Estate 4WD B47D20A		2051120L	Drive Shaft	30	27		77	761					
	2014.07-2017.02	8AT	R	R	Estate 4WD B47D20A		2051130L	Drive Shaft	30	27		77	814					
2.0 (155 kw)	2014.07-2017.02	8AT	F	L	Estate 4WD B47D20A		2015810L	Drive Shaft	37	27	65		562					
	2014.07-2017.02	8AT	F	R	Estate 4WD B47D20A		2016810L	Drive Shaft	37	27	65		864					
	2014.07-2017.02	8AT	R	L	Estate 4WD B47D20A		2051120L	Drive Shaft	30	27		77	761					
	2014.07-2017.02	8AT	R	R	Estate 4WD B47D20A		2051130L	Drive Shaft	30	27		77	814					
520i																		
1.6 (125 kw)	2013.07-2016.10	8AT	R	L	Saloon RWD N20B16A		2051120L	Drive Shaft	30	27		77	761					
	2013.07-2016.10	8AT	R	R	Saloon RWD N20B16A		2051130L	Drive Shaft	30	27		77	814					
2.0 (120 kw)	2011.09-2016.10	6MT	R	L	Saloon RWD N20B20A/N20B20B		2051140L	Drive Shaft	30	27		77	764					
	2011.09-2016.10	6MT	R	R	Saloon RWD N20B20A/N20B20B		2051150L	Drive Shaft	30	27		77	818					
	2011.09-2016.10	8AT	R	L	Saloon RWD N20B20A/N20B20B		2051120L	Drive Shaft	30	27		77	761					
	2011.09-2016.10	8AT	R	R	Saloon RWD N20B20A/N20B20B		2051130L	Drive Shaft	30	27		77	814					
2.0 (135 kw)	2011.09-2016.10	6MT	R	L	Saloon RWD N20B20A/N20B20B		2051140L	Drive Shaft	30	27		77	764					
	2011.09-2016.10	6MT	R	R	Saloon RWD N20B20A/N20B20B		2051150L	Drive Shaft	30	27		77	818					
	2011.09-2016.10	8AT	R	L	Saloon RWD N20B20A/N20B20B		2051120L	Drive Shaft	30	27		77	761					
	2011.09-2016.10	8AT	R	R	Saloon RWD N20B20A/N20B20B		2051130L	Drive Shaft	30	27		77	814					
520i Touring																		
2.0 (120 kw)	2011.09-2017.02	6AT	R	L	Estate RWD N20B20A/N20B20B		2051120L	Drive Shaft	30	27		77	761					
	2011.09-2017.02	6AT	R	R	Estate RWD N20B20A/N20B20B		2051130L	Drive Shaft	30	27		77	814					
	2011.09-2017.02	6MT	R	L	Estate RWD N20B20A/N20B20B		2051140L	Drive Shaft	30	27		77	764					
	2011.09-2017.02	6MT	R	R	Estate RWD N20B20A/N20B20B		2051150L	Drive Shaft	30	27		77	818					
2.0 (135 kw)	2011.09-2017.02	6AT	R	L	Estate RWD N20B20A/N20B20B		2051120L	Drive Shaft	30	27		77	761					
	2011.09-2017.02	6AT	R	R	Estate RWD N20B20A/N20B20B		2051130L	Drive Shaft	30	27		77	814					
	2011.09-2017.02	6MT	R	L	Estate RWD N20B20A/N20B20B		2051140L	Drive Shaft	30	27		77	764					
	2011.09-2017.02	6MT	R	R	Estate RWD N20B20A/N20B20B		2051150L	Drive Shaft	30	27		77	818					
523i																		
2.5 (150 kw)	2010.01-2011.08	8AT	R	L	Saloon RWD N52B25AN52B25AFN52B25B/N52B20BF		2051120L	Drive Shaft	30	27		77	761					
	2010.01-2011.08	8AT	R	R	Saloon RWD N52B25AN52B25AFN52B25B/N52B20BF		2051130L	Drive Shaft	30	27		77	814					
3.0 (150 kw)	2010.01-2011.08	8AT	R	L	Saloon RWD N53B30A		2051120L	Drive Shaft	30	27		77	761					
	2010.01-2011.08	8AT	R	R	Saloon RWD N53B30A		2051130L	Drive Shaft	30	27		77	814					
3.0 (155 kw)	2010.01-2011.08	8AT	R	L	Saloon RWD N53B30A		2051120L	Drive Shaft	30	27		77	761					
	2010.01-2011.08	8AT	R	R	Saloon RWD N53B30A		2051130L	Drive Shaft	30	27		77	814					



		TRANSM.	F/R	L/R	BODY STYLE & DRIVE TYPE & ENGINE	REMARKS	GSP Ref.		PRODUCT	ABS	Technical Specifications				
											A	B	C	H	L
BMW															
523i Touring															
2.5 (150 kw)	2009.11-2011.12	8AT	R	L	Estate RWD N52B25A/N52B25AF/N52B25B		2051120L	Drive Shaft		30	27		77	761	
	2009.11-2011.12	8AT	R	R	Estate RWD N52B25A/N52B25AF/N52B25B		2051130L	Drive Shaft		30	27		77	814	
3.0 (150 kw)	2010.09-2011.12	8AT	R	L	Estate RWD N53B30A		2051120L	Drive Shaft		30	27		77	761	
	2010.09-2011.12	8AT	R	R	Estate RWD N53B30A		2051130L	Drive Shaft		30	27		77	814	
525d															
2.0 (155 kw)	2011.09-2016.10	8AT	R	L	Saloon RWD N47D20D/N47S1D20D		2051140L	Drive Shaft		30	27		77	764	
	2011.09-2016.10	8AT	R	R	Saloon RWD N47D20D/N47S1D20D		2051150L	Drive Shaft		30	27		77	818	
	2011.09-2016.10	AT	R	L	Saloon RWD N47D20D/N47S1D20D	Date From:2012.01	2051120L	Drive Shaft		30	27		77	761	
	2011.09-2016.10	AT	R	R	Saloon RWD N47D20D/N47S1D20D	Date From:2012.01	2051130L	Drive Shaft		30	27		77	814	
2.0 (160 kw)	2011.09-2016.10	8AT	R	L	Saloon RWD N47D20D		2051140L	Drive Shaft		30	27		77	764	
	2011.09-2016.10	8AT	R	R	Saloon RWD N47D20D		2051150L	Drive Shaft		30	27		77	818	
3.0 (150 kw)	2010.03-2013.06	6MT	R	L	Saloon RWD N57D30A		2051370L	Drive Shaft		30	32		77	758	
	2010.03-2013.06	6MT	R	R	Saloon RWD N57D30A		2051390L	Drive Shaft		30	32		77	814	
	2010.03-2013.06	8AT	R	L	Saloon RWD N57D30A		2051140L	Drive Shaft		30	27		77	764	
	2010.03-2013.06	8AT	R	R	Saloon RWD N57D30A		2051150L	Drive Shaft		30	27		77	818	
525d Touring															
2.0 (155 kw)	2011.09-2017.02	8AT	R	L	Estate RWD N47D20D/N47S1D20D		2051140L	Drive Shaft		30	27		77	764	
	2011.09-2017.02	8AT	R	R	Estate RWD N47D20D/N47S1D20D		2051150L	Drive Shaft		30	27		77	818	
	2011.09-2017.02	AT	R	L	Estate RWD N47D20D/N47S1D20D	Date From:2012.01	2051120L	Drive Shaft		30	27		77	761	
	2011.09-2017.02	AT	R	R	Estate RWD N47D20D/N47S1D20D	Date From:2012.01	2051130L	Drive Shaft		30	27		77	814	
2.0 (160 kw)	2011.09-2017.02	8AT	R	L	Estate RWD N47D20D		2051140L	Drive Shaft		30	27		77	764	
	2011.09-2017.02	8AT	R	R	Estate RWD N47D20D		2051150L	Drive Shaft		30	27		77	818	
3.0 (150 kw)	2010.09-2011.08	6MT	R	L	Estate RWD N57D30A		2051370L	Drive Shaft		30	32		77	758	
	2010.09-2011.08	6MT	R	R	Estate RWD N57D30A		2051390L	Drive Shaft		30	32		77	814	
	2010.09-2011.08	8AT	R	L	Estate RWD N57D30A		2051140L	Drive Shaft		30	27		77	764	
	2010.09-2011.08	8AT	R	R	Estate RWD N57D30A		2051150L	Drive Shaft		30	27		77	818	
525d xDrive															
2.0 (155 kw)	2011.09-2016.10	8AT	F	L	Saloon 4WD N47D20D		2015810L	Drive Shaft		37	27	65		562	
	2011.09-2016.10	8AT	F	R	Saloon 4WD N47D20D		2016810L	Drive Shaft		37	27	65		864	
	2011.09-2016.10	8AT	R	L	Saloon 4WD N47D20D		2051140L	Drive Shaft		30	27		77	764	
	2011.09-2016.10	8AT	R	R	Saloon 4WD N47D20D		2051150L	Drive Shaft		30	27		77	818	
2.0 (160 kw)	2011.09-2016.10	8AT	F	L	Saloon 4WD N47D20D		2015810L	Drive Shaft		37	27	65		562	
	2011.09-2016.10	8AT	F	R	Saloon 4WD N47D20D		2016810L	Drive Shaft		37	27	65		864	
	2011.09-2016.10	8AT	R	L	Saloon 4WD N47D20D		2051140L	Drive Shaft		30	27		77	764	
	2011.09-2016.10	8AT	R	R	Saloon 4WD N47D20D		2051150L	Drive Shaft		30	27		77	818	
525d xDrive Touring															
2.0 (155 kw)	2013.07-2017.02	8AT	F	L	Estate 4WD N47D20D		2015810L	Drive Shaft		37	27	65		562	
	2013.07-2017.02	8AT	F	R	Estate 4WD N47D20D		2016810L	Drive Shaft		37	27	65		864	
	2013.07-2017.02	8AT	R	L	Estate 4WD N47D20D		2051140L	Drive Shaft		30	27		77	764	
	2013.07-2017.02	8AT	R	R	Estate 4WD N47D20D		2051150L	Drive Shaft		30	27		77	818	
2.0 (160 kw)	2013.07-2017.02	8AT	F	L	Estate 4WD N47D20D		2015810L	Drive Shaft		37	27	65		562	
	2013.07-2017.02	8AT	F	R	Estate 4WD N47D20D		2016810L	Drive Shaft		37	27	65		864	
	2013.07-2017.02	8AT	R	L	Estate 4WD N47D20D		2051140L	Drive Shaft		30	27		77	764	
	2013.07-2017.02	8AT	R	R	Estate 4WD N47D20D		2051150L	Drive Shaft		30	27		77	818	
528i															
2.0 (180 kw)	2011.09-2016.10	6MT	R	L	Saloon RWD N20B20A		2051140L	Drive Shaft		30	27		77	764	
	2011.09-2016.10	6MT	R	R	Saloon RWD N20B20A		2051150L	Drive Shaft		30	27		77	818	
	2011.09-2016.10	8AT	R	L	Saloon RWD N20B20A		2051120L	Drive Shaft		30	27		77	761	
	2011.09-2016.10	8AT	R	R	Saloon RWD N20B20A		2051130L	Drive Shaft		30	27		77	814	
3.0 (190 kw)	2010.03-2011.08	8AT	R	L	Saloon RWD N53B30A		2051120L	Drive Shaft		30	27		77	761	
	2010.03-2011.08	8AT	R	R	Saloon RWD N53B30A		2051130L	Drive Shaft		30	27		77	814	
528i Touring															
2.0 (180 kw)	2011.09-2017.02	6MT	R	L	Estate RWD N20B20A		2051140L	Drive Shaft		30	27		77	764	
	2011.09-2017.02	6MT	R	R	Estate RWD N20B20A		2051150L	Drive Shaft		30	27		77	818	
	2011.09-2017.02	8AT	R	L	Estate RWD N20B20A		2051120L	Drive Shaft		30	27		77	761	
	2011.09-2017.02	8AT	R	R	Estate RWD N20B20A		2051130L	Drive Shaft		30	27		77	814	
3.0 (190 kw)	2010.09-2013.06	8AT	R	L	Estate RWD N53B30A		2051120L	Drive Shaft		30	27		77	761	
	2010.09-2013.06	8AT	R	R	Estate RWD N53B30A		2051130L	Drive Shaft		30	27		77	814	
528i xDrive															
2.0 (180 kw)	2011.09-2016.10	8AT	F	L	Saloon 4WD N20B20A		2015810L	Drive Shaft		37	27	65		562	
	2011.09-2016.10	8AT	F	R	Saloon 4WD N20B20A		2016810L	Drive Shaft		37	27	65		864	
	2011.09-2016.10	8AT	R	L	Saloon 4WD N20B20A		2051120L	Drive Shaft		30	27		77	761	
	2011.09-2016.10	8AT	R	R	Saloon 4WD N20B20A		2051130L	Drive Shaft		30	27		77	814	





		TRANSM.	F/R	L/R	BODY STYLE & DRIVE TYPE & ENGINE	REMARKS	GSP Ref.		Technical Specifications					
									PRODUCT	ABS	A	B	C	H
BMW														
528i xDrive Touring														
2.0 (180 kw)	2011.09-2017.02	8AT	F	L	Estate 4WD N20B20A		2015810L	Drive Shaft		37	27	65		562
	2011.09-2017.02	8AT	F	R	Estate 4WD N20B20A		2016810L	Drive Shaft		37	27	65		864
	2011.09-2017.02	8AT	R	L	Estate 4WD N20B20A		2051120L	Drive Shaft		30	27		77	761
	2011.09-2017.02	8AT	R	R	Estate 4WD N20B20A		2051130L	Drive Shaft		30	27		77	814
530d														
3.0 (180 kw)	2010.01-2011.08	8AT	R	L	Saloon RWD N57D30A		2051370L	Drive Shaft		30	32		77	758
	2010.01-2011.08	8AT	R	R	Saloon RWD N57D30A		2051390L	Drive Shaft		30	32		77	814
3.0 (190 kw)	2011.09-2016.10	8AT	R	L	Saloon RWD N57D30A		2051370L	Drive Shaft		30	32		77	758
	2011.09-2016.10	8AT	R	R	Saloon RWD N57D30A		2051390L	Drive Shaft		30	32		77	814
3.0 (210 kw)	2010.09-2016.10	8AT	R	L	Saloon RWD N57D30A		2051370L	Drive Shaft		30	32		77	758
	2010.09-2016.10	8AT	R	R	Saloon RWD N57D30A		2051390L	Drive Shaft		30	32		77	814
530d Touring														
3.0 (180 kw)	2010.06-2011.08	8AT	R	L	Estate RWD N57D30A		2051370L	Drive Shaft		30	32		77	758
	2010.06-2011.08	8AT	R	R	Estate RWD N57D30A		2051390L	Drive Shaft		30	32		77	814
3.0 (190 kw)	2011.09-2017.02	8AT	R	L	Estate RWD N57D30A		2051370L	Drive Shaft		30	32		77	758
	2011.09-2017.02	8AT	R	R	Estate RWD N57D30A		2051390L	Drive Shaft		30	32		77	814
3.0 (210 kw)	2011.09-2017.02	8AT	R	L	Estate RWD N57D30A		2051370L	Drive Shaft		30	32		77	758
	2011.09-2017.02	8AT	R	R	Estate RWD N57D30A		2051390L	Drive Shaft		30	32		77	814
530d xDrive														
3.0 (190 kw)	2011.03-2016.10	8AT	F	L	Saloon 4WD N57D30A		2015810L	Drive Shaft		37	27	65		562
	2011.03-2016.10	8AT	F	R	Saloon 4WD N57D30A		2016810L	Drive Shaft		37	27	65		864
	2011.03-2016.10	8AT	R	L	Saloon 4WD N57D30A		2051370L	Drive Shaft		30	32		77	758
	2011.03-2016.10	8AT	R	R	Saloon 4WD N57D30A		2051390L	Drive Shaft		30	32		77	814
3.0 (210 kw)	2011.03-2016.10	8AT	F	L	Saloon 4WD N57D30A		2015810L	Drive Shaft		37	27	65		562
	2011.03-2016.10	8AT	F	R	Saloon 4WD N57D30A		2016810L	Drive Shaft		37	27	65		864
	2011.03-2016.10	8AT	R	L	Saloon 4WD N57D30A		2051370L	Drive Shaft		30	32		77	758
	2011.03-2016.10	8AT	R	R	Saloon 4WD N57D30A		2051390L	Drive Shaft		30	32		77	814
530d xDrive Gran Turismo														
3.0 (180 kw)	2010.06-2012.06	AT	F	L	Hatchback 4WD N57D30A		2027300L	Drive Shaft		37	27	65		572
3.0 (180 kw)	2012.07-2017.02	AT	F	L	Hatchback 4WD N57D30A		2027300L	Drive Shaft		37	27	65		572
530d xDrive Touring														
3.0 (190 kw)	2011.03-2017.02	8AT	F	L	Estate 4WD N57D30A		2015810L	Drive Shaft		37	27	65		562
	2011.03-2017.02	8AT	F	R	Estate 4WD N57D30A		2016810L	Drive Shaft		37	27	65		864
	2011.03-2017.02	8AT	R	L	Estate 4WD N57D30A		2051370L	Drive Shaft		30	32		77	758
	2011.03-2017.02	8AT	R	R	Estate 4WD N57D30A		2051390L	Drive Shaft		30	32		77	814
3.0 (210 kw)	2011.03-2017.02	8AT	F	L	Estate 4WD N57D30A		2015810L	Drive Shaft		37	27	65		562
	2011.03-2017.02	8AT	F	R	Estate 4WD N57D30A		2016810L	Drive Shaft		37	27	65		864
	2011.03-2017.02	8AT	R	L	Estate 4WD N57D30A		2051370L	Drive Shaft		30	32		77	758
	2011.03-2017.02	8AT	R	R	Estate 4WD N57D30A		2051390L	Drive Shaft		30	32		77	814
530i														
3.0 (190 kw)	2010.03-2013.06	8AT	R	L	Saloon RWD N52B30A/N52B30AF/N52B30BF		2051120L	Drive Shaft		30	27		77	761
	2010.03-2013.06	8AT	R	R	Saloon RWD N52B30A/N52B30AF/N52B30BF		2051130L	Drive Shaft		30	27		77	814
3.0 (200 kw)	2011.05-2013.06	8AT	R	L	Saloon RWD N53B30A		2051120L	Drive Shaft		30	27		77	761
	2011.05-2013.06	8AT	R	R	Saloon RWD N53B30A		2051130L	Drive Shaft		30	27		77	814
530i Touring														
3.0 (190 kw)	2010.03-2013.06	8AT	R	L	Estate RWD N52B30A/N52B30AF		2051120L	Drive Shaft		30	27		77	761
	2010.03-2013.06	8AT	R	R	Estate RWD N52B30A/N52B30AF		2051130L	Drive Shaft		30	27		77	814
3.0 (200 kw)	2011.07-2013.06	8AT	R	L	Estate RWD N53B30A		2051120L	Drive Shaft		30	27		77	761
	2011.07-2013.06	8AT	R	R	Estate RWD N53B30A		2051130L	Drive Shaft		30	27		77	814
535d														
3.0 (220 kw)	2010.09-2011.08	8AT	R	L	Saloon RWD N57D30B		2051370L	Drive Shaft		30	32		77	758
	2010.09-2011.08	8AT	R	R	Saloon RWD N57D30B		2051390L	Drive Shaft		30	32		77	814
3.0 (230 kw)	2011.09-2016.10	8AT	R	L	Saloon RWD N57D30B		2051370L	Drive Shaft		30	32		77	758
	2011.09-2016.10	8AT	R	R	Saloon RWD N57D30B		2051390L	Drive Shaft		30	32		77	814
535d Touring														
3.0 (220 kw)	2010.09-2011.08	8AT	R	L	Estate RWD N57D30B		2051370L	Drive Shaft		30	32		77	758
	2010.09-2011.08	8AT	R	R	Estate RWD N57D30B		2051390L	Drive Shaft		30	32		77	814
3.0 (230 kw)	2011.09-2017.02	8AT	R	L	Estate RWD N57D30B		2051370L	Drive Shaft		30	32		77	758
	2011.09-2017.02	8AT	R	R	Estate RWD N57D30B		2051390L	Drive Shaft		30	32		77	814
535d xDrive														
3.0 (230 kw)	2011.02-2016.10	8AT	F	L	Saloon 4WD N57D30B		2015810L	Drive Shaft		37	27	65		562
	2011.02-2016.10	8AT	F	R	Saloon 4WD N57D30B		2016810L	Drive Shaft		37	27	65		864
	2011.02-2016.10	8AT	R	L	Saloon 4WD N57D30B		2051370L	Drive Shaft		30	32		77	758
	2011.02-2016.10	8AT	R	R	Saloon 4WD N57D30B		2051390L	Drive Shaft		30	32		77	814



	 YEAR	TRANSM.	F/R	L/R	BODY STYLE & DRIVE TYPE & ENGINE	REMARKS	GSP Ref.	 PRODUCT	ABS	Technical Specifications				
										A	B	C	H	L
BMW														
535d xDrive Gran Turismo														
3.0 (220 kw)	2010.03-2012.06	AT	F	L	Hatchback 4WD N57D30B		2027300L	Drive Shaft		37	27	65		572
3.0 (230 kw)	2012.07-2017.02	AT	F	L	Hatchback 4WD N57D30B		2027300L	Drive Shaft		37	27	65		572
535d xDrive Touring														
3.0 (230 kw)	2011.09-2017.02	8AT	F	L	Estate 4WD N57D30B		2015810L	Drive Shaft		37	27	65		562
	2011.09-2017.02	8AT	F	R	Estate 4WD N57D30B		2016810L	Drive Shaft		37	27	65		864
	2011.09-2017.02	8AT	R	L	Estate 4WD N57D30B		2051370L	Drive Shaft		30	32		77	758
	2011.09-2017.02	8AT	R	R	Estate 4WD N57D30B		2051390L	Drive Shaft		30	32		77	814
535i														
3.0 (225 kw)	2010.01-2016.10	8AT	R	L	Saloon RWD N55B30A	Date To:2011.05	2051370L	Drive Shaft		30	32		77	758
535i Touring														
3.0 (225 kw)	2010.06-2017.02	8AT	R	L	Estate RWD N55B30A	Date To:2011.05	2051370L	Drive Shaft		30	32		77	758
	2010.06-2017.02	8AT	R	R	Estate RWD N55B30A	Date From:2011.06	2051130L	Drive Shaft		30	27		77	814
	2010.06-2017.02	AT	R	L	Estate RWD N55B30A		2051120L	Drive Shaft		30	27		77	761
535i xDrive														
3.0 (225 kw)	2011.03-2016.10	8AT	F	L	Saloon 4WD N55B30A		2015810L	Drive Shaft		37	27	65		562
	2011.03-2016.10	8AT	F	R	Saloon 4WD N55B30A		2016810L	Drive Shaft		37	27	65		864
	2011.03-2016.10	8AT	R	L	Saloon 4WD N55B30A		2051120L	Drive Shaft		30	27		77	761
	2011.03-2016.10	8AT	R	R	Saloon 4WD N55B30A		2051130L	Drive Shaft		30	27		77	814
3.0 (240 kw)	2013.07-2016.10	8AT	F	L	Saloon 4WD N55B30A		2015810L	Drive Shaft		37	27	65		562
	2013.07-2016.10	8AT	F	R	Saloon 4WD N55B30A		2016810L	Drive Shaft		37	27	65		864
	2013.07-2016.10	8AT	R	L	Saloon 4WD N55B30A		2051120L	Drive Shaft		30	27		77	761
	2013.07-2016.10	8AT	R	R	Saloon 4WD N55B30A		2051130L	Drive Shaft		30	27		77	814
535i xDrive Gran Turismo														
3.0 (225 kw)	2010.09-2017.02	AT	F	L	Hatchback 4WD N55B30A		2027300L	Drive Shaft		37	27	65		572
535i xDrive Touring														
3.0 (225 kw)	2011.09-2017.02	8AT	F	L	Estate 4WD N55B30A		2015810L	Drive Shaft		37	27	65		562
	2011.09-2017.02	8AT	F	R	Estate 4WD N55B30A		2016810L	Drive Shaft		37	27	65		864
	2011.09-2017.02	8AT	R	L	Estate 4WD N55B30A		2051120L	Drive Shaft		30	27		77	761
	2011.09-2017.02	8AT	R	R	Estate 4WD N55B30A		2051130L	Drive Shaft		30	27		77	814
3.0 (240 kw)	2013.07-2017.02	8AT	F	L	Estate 4WD N55B30A		2015810L	Drive Shaft		37	27	65		562
	2013.07-2017.02	8AT	F	R	Estate 4WD N55B30A		2016810L	Drive Shaft		37	27	65		864
	2013.07-2017.02	8AT	R	L	Estate 4WD N55B30A		2051120L	Drive Shaft		30	27		77	761
	2013.07-2017.02	8AT	R	R	Estate 4WD N55B30A		2051130L	Drive Shaft		30	27		77	814
550i														
4.4 (300 kw)	2010.03-2013.06	8AT	R	L	Saloon RWD N63B44A		2051370L	Drive Shaft		30	32		77	758
4.4 (330 kw)	2013.07-2016.10	8AT	R	L	Saloon RWD N63B44B		2051370L	Drive Shaft		30	32		77	758
550i Touring														
4.4 (300 kw)	2010.03-2013.06	8AT	R	L	Estate RWD N63B44A		2051370L	Drive Shaft		30	32		77	758
	2010.03-2013.06	8AT	R	R	Estate RWD N63B44A		2051390L	Drive Shaft		30	32		77	814
4.4 (330 kw)	2013.07-2017.02	8AT	R	L	Estate RWD N63B44B		2051370L	Drive Shaft		30	32		77	758
	2013.07-2017.02	8AT	R	R	Estate RWD N63B44B		2051390L	Drive Shaft		30	32		77	814
550i xDrive														
4.4 (300 kw)	2010.09-2015.09	8AT	F	L	Saloon 4WD N63B44A		2015810L	Drive Shaft		37	27	65		562
	2010.09-2015.09	8AT	F	R	Saloon 4WD N63B44A		2017160L	Drive Shaft		37	27	65		871
	2010.09-2015.09	8AT	R	L	Saloon 4WD N63B44A		2051370L	Drive Shaft		30	32		77	758
4.4 (330 kw)	2013.07-2016.10	8AT	F	L	Saloon 4WD N63B44B		2015810L	Drive Shaft		37	27	65		562
	2013.07-2016.10	8AT	F	R	Saloon 4WD N63B44B		2017160L	Drive Shaft		37	27	65		871
	2013.07-2016.10	8AT	R	L	Saloon 4WD N63B44B		2051370L	Drive Shaft		30	32		77	758
550i xDrive Gran Turismo														
4.4 (300 kw)	2010.06-2012.06	AT	F	L	Hatchback 4WD N63B44A		2027300L	Drive Shaft		37	27	65		572
4.4 (330 kw)	2012.07-2017.02	AT	F	L	Hatchback 4WD N63B44B		2027300L	Drive Shaft		37	27	65		572
640d xDrive Cabrio														
3.0 (230 kw)	2012.03-2018.06	8AT	F	L	Cabriolet 4WD N57D30B		2015810L	Drive Shaft		37	27	65		562
	2012.03-2018.06	8AT	F	R	Cabriolet 4WD N57D30B		2016810L	Drive Shaft		37	27	65		864
640d xDrive Coupe														
3.0 (230 kw)	2012.03-2017.10	8AT	F	L	Coupe 4WD N57D30B		2015810L	Drive Shaft		37	27	65		562
	2012.03-2017.10	8AT	F	R	Coupe 4WD N57D30B		2016810L	Drive Shaft		37	27	65		864
640d xDrive Gran Coupe														
3.0 (230 kw)	2013.03-2018.10	8AT	F	L	Coupe 4WD N57D30B		2015810L	Drive Shaft		37	27	65		562
	2013.03-2018.10	8AT	F	R	Coupe 4WD N57D30B		2016810L	Drive Shaft		37	27	65		864
640i xDrive Cabrio														
3.0 (235 kw)	2013.03-2018.06	8AT	F	L	Cabriolet 4WD N55B30A		2015810L	Drive Shaft		37	27	65		562
	2013.03-2018.06	8AT	F	R	Cabriolet 4WD N55B30A		2016810L	Drive Shaft		37	27	65		864
	2013.03-2018.06	AT	R	L	Cabriolet 4WD N55B30A		2051120L	Drive Shaft		30	27		77	761
	2013.03-2018.06	AT	R	R	Cabriolet 4WD N55B30A		2051130L	Drive Shaft		30	27		77	814



		TRANSM.	F/R	L/R	BODY STYLE & DRIVE TYPE & ENGINE	REMARKS	GSP Ref.		Technical Specifications						
									PRODUCT	ABS	A	B	C	H	L
YEAR															
BMW															
640i xDrive Coupe															
3.0 (235 kw)	2013.03-2017.10	8AT	F	L	Coupe 4WD N55B30A		2015810L	Drive Shaft	37	27	65		562		
	2013.03-2017.10	8AT	F	R	Coupe 4WD N55B30A		2016810L	Drive Shaft	37	27	65		864		
	2013.03-2017.10	AT	R	L	Coupe 4WD N55B30A		2051120L	Drive Shaft	30	27		77	761		
	2013.03-2017.10	AT	R	R	Coupe 4WD N55B30A		2051130L	Drive Shaft	30	27		77	814		
640i xDrive Gran Coupe															
3.0 (235 kw)	2013.03-2018.10	8AT	F	L	Coupe 4WD N55B30A		2015810L	Drive Shaft	37	27	65		562		
	2013.03-2018.10	8AT	F	R	Coupe 4WD N55B30A		2016810L	Drive Shaft	37	27	65		864		
	2013.03-2018.10	AT	R	L	Coupe 4WD N55B30A		2051120L	Drive Shaft	30	27		77	761		
	2013.03-2018.10	AT	R	R	Coupe 4WD N55B30A		2051130L	Drive Shaft	30	27		77	814		
650i xDrive Cabrio															
4.4 (300 kw)	2011.09-2012.06	8AT	F	L	Cabriolet 4WD N63B44A		2015810L	Drive Shaft	37	27	65		562		
	2011.09-2012.06	8AT	F	R	Cabriolet 4WD N63B44A		2017160L	Drive Shaft	37	27	65		871		
4.4 (330 kw)	2012.07-2018.06	8AT	F	L	Cabriolet 4WD N63B44B		2015810L	Drive Shaft	37	27	65		562		
	2012.07-2018.06	8AT	F	R	Cabriolet 4WD N63B44B		2017160L	Drive Shaft	37	27	65		871		
650i xDrive Coupe															
4.4 (300 kw)	2011.09-2015.02	8AT	F	L	Coupe 4WD N63B44A		2015810L	Drive Shaft	37	27	65		562		
	2011.09-2015.02	8AT	F	R	Coupe 4WD N63B44A		2017160L	Drive Shaft	37	27	65		871		
4.4 (330 kw)	2012.07-2017.10	8AT	F	L	Coupe 4WD N63B44B		2015810L	Drive Shaft	37	27	65		562		
	2012.07-2017.10	8AT	F	R	Coupe 4WD N63B44B		2017160L	Drive Shaft	37	27	65		871		
650i xDrive Gran Coupe															
4.4 (330 kw)	2012.07-2018.10	8AT	F	L	Coupe 4WD N63B44B		2015810L	Drive Shaft	37	27	65		562		
	2012.07-2018.10	8AT	F	R	Coupe 4WD N63B44B		2017160L	Drive Shaft	37	27	65		871		
730d xDrive															
3.0 (155 kw)	2013.06-2015.05	AT	F	L	Saloon 4WD N57D30A		2027300L	Drive Shaft	37	27	65		572		
3.0 (190 kw)	2012.07-2015.08	AT	F	L	Saloon 4WD N57D30A		2027300L	Drive Shaft	37	27	65		572		
740d xDrive															
3.0 (225 kw)	2010.03-2012.06	AT	F	L	Saloon 4WD N57D30B		2027300L	Drive Shaft	37	27	65		572		
3.0 (230 kw)	2012.07-2015.08	AT	F	L	Saloon 4WD N57D30B		2027300L	Drive Shaft	37	27	65		572		
740i xDrive															
3.0 (235 kw)	2012.07-2015.08	AT	F	L	Saloon 4WD N55B30A		2027300L	Drive Shaft	37	27	65		572		
750d xDrive															
3.0 (280 kw)	2012.07-2015.08	AT	F	L	Saloon 4WD N57D30C		2027300L	Drive Shaft	37	27	65		572		
750i xDrive															
4.4 (300 kw)	2009.09-2012.06	AT	F	L	Saloon 4WD N63B44A		2027300L	Drive Shaft	37	27	65		572		
4.4 (330 kw)	2012.07-2015.06	AT	F	L	Saloon 4WD N63B44B		2027300L	Drive Shaft	37	27	65		572		
i3															
0.6 (135 kw)	2017.11-	ET	R	L	Hatchback RWD W20K06A		2039680L	Drive Shaft	31	27	56		667		
	2017.11-	ET	R	R	Hatchback RWD W20K06A		2039250L	Drive Shaft	31	27	56		782		
ET (75 kw)	2017.11-	ET	R	L	Hatchback RWD IB1P25B		2039680L	Drive Shaft	31	27	56		667		
	2017.11-	ET	R	R	Hatchback RWD IB1P25B		2039250L	Drive Shaft	31	27	56		782		
ET (125 kw)	2013.08-	ET	R	L	Hatchback RWD IB1P25B		2039680L	Drive Shaft	31	27	56		667		
	2013.08-	ET	R	R	Hatchback RWD IB1P25B		2039250L	Drive Shaft	31	27	56		782		
ET (135 kw)	2017.11-	ET	R	L	Hatchback RWD IB1P25B		2039680L	Drive Shaft	31	27	56		667		
	2017.11-	ET	R	R	Hatchback RWD IB1P25B		2039250L	Drive Shaft	31	27	56		782		
M135i xDrive															
3.0 (235 kw)	2012.02-	8AT	F	L	Hatchback 4WD N55B30A		2020520L	Drive Shaft	31	27	56.8		550		
	2012.02-	8AT	F	R	Hatchback 4WD N55B30A		2020530L	Drive Shaft	31	27	56.8		841		
	2012.02-	8AT	R	L	Hatchback 4WD N55B30A		2050660L	Drive Shaft	28	27		71	743		
	2012.02-	8AT	R	R	Hatchback 4WD N55B30A		2050670L	Drive Shaft	28	27		71	796		
	2012.11-2015.02	8AT	F	L	Hatchback 4WD N55B30A		2020520L	Drive Shaft	31	27	56.8		550		
	2012.11-2015.02	8AT	F	R	Hatchback 4WD N55B30A		2020530L	Drive Shaft	31	27	56.8		841		
	2012.11-2015.02	8AT	R	L	Hatchback 4WD N55B30A		2050660L	Drive Shaft	28	27		71	743		
	2012.11-2015.02	8AT	R	R	Hatchback 4WD N55B30A		2050670L	Drive Shaft	28	27		71	796		
3.0 (240 kw)	2015.03-	AT	F	L	Hatchback 4WD N55B30A		2050660L	Drive Shaft	28	27		71	743		
	2015.03-	AT/MT	F	L	Hatchback 4WD N55B30A		2020520L	Drive Shaft	31	27	56.8		550		
	2015.03-	AT/MT	F	R	Hatchback 4WD N55B30A		2020530L	Drive Shaft	31	27	56.8		841		
	2015.03-	AT	R	R	Hatchback 4WD N55B30A		2050670L	Drive Shaft	28	27		71	796		
	2015.03-2016.06	AT	F	L	Hatchback 4WD N55B30A		2050660L	Drive Shaft	28	27		71	743		
	2015.03-2016.06	AT/MT	F	L	Hatchback 4WD N55B30A		2020520L	Drive Shaft	31	27	56.8		550		
	2015.03-2016.06	AT/MT	F	R	Hatchback 4WD N55B30A		2020530L	Drive Shaft	31	27	56.8		841		
	2015.03-2016.06	AT	R	R	Hatchback 4WD N55B30A		2050670L	Drive Shaft	28	27		71	796		
M140i xDrive															
3.0 (250 kw)	2015.09-	8AT	F	L	Hatchback 4WD B58B30A		2020520L	Drive Shaft	31	27	56.8		550		
	2015.09-	8AT	F	R	Hatchback 4WD B58B30A		2020530L	Drive Shaft	31	27	56.8		841		
	2015.09-	8AT	R	R	Hatchback 4WD B58B30A		2050670L	Drive Shaft	28	27		71	796		





		TRANSM.	F/R	L/R	BODY STYLE & DRIVE TYPE & ENGINE	REMARKS	GSP Ref.		PRODUCT ABS	Technical Specifications									
										A	B	C	H	L					
BMW M140i xDrive																			
3.0 (250 kw)	2016.07-2019.06	8AT	F	L	Hatchback 4WD B58B30A		2020520L	Drive Shaft		31	27	56.8		550					
	2016.07-2019.06	8AT	F	R	Hatchback 4WD B58B30A		2020530L	Drive Shaft		31	27	56.8		841					
	2016.07-2019.06	8AT	R	R	Hatchback 4WD B58B30A		2050670L	Drive Shaft		28	27		71	796					
M235i xDrive Cabrio																			
3.0 (240 kw)	2015.07-	8AT	F	L	Cabriolet 4WD N55B30A		2020520L	Drive Shaft		31	27	56.8		550					
	2015.07-	8AT	F	R	Cabriolet 4WD N55B30A		2020530L	Drive Shaft		31	27	56.8		841					
	2015.07-	AT	R	L	Cabriolet 4WD N55B30A		2050660L	Drive Shaft		28	27		71	743					
	2015.07-	AT	R	R	Cabriolet 4WD N55B30A		2050670L	Drive Shaft		28	27		71	796					
M235i xDrive Coupe																			
3.0 (240 kw)	2014.07-	8AT	F	L	Coupe 4WD N55B30A		2020520L	Drive Shaft		31	27	56.8		550					
	2014.07-	8AT	F	R	Coupe 4WD N55B30A		2020530L	Drive Shaft		31	27	56.8		841					
	2014.07-	AT	R	L	Coupe 4WD N55B30A		2050660L	Drive Shaft		28	27		71	743					
	2014.07-	AT	R	R	Coupe 4WD N55B30A		2050670L	Drive Shaft		28	27		71	796					
M240i xDrive Cabrio																			
3.0 (250 kw)	2015.09-	8AT	F	L	Cabriolet 4WD B58B30A		2020520L	Drive Shaft		31	27	56.8		550					
	2015.09-	8AT	F	R	Cabriolet 4WD B58B30A		2020530L	Drive Shaft		31	27	56.8		841					
	2015.09-	8AT	R	R	Cabriolet 4WD B58B30A		2050670L	Drive Shaft		28	27		71	796					
M240i xDrive Coupe																			
3.0 (250 kw)	2015.09-	8AT	F	L	Coupe 4WD B58B30A		2020520L	Drive Shaft		31	27	56.8		550					
	2015.09-	8AT	F	R	Coupe 4WD B58B30A		2020530L	Drive Shaft		31	27	56.8		841					
	2015.09-	8AT	R	R	Coupe 4WD B58B30A		2050670L	Drive Shaft		28	27		71	796					
M550d xDrive																			
3.0 (280 kw)	2012.03-2016.10	8AT	F	L	Saloon 4WD N57D30C		2015810L	Drive Shaft		37	27	65		562					
	2012.03-2016.10	8AT	F	R	Saloon 4WD N57D30C		2016810L	Drive Shaft		37	27	65		864					
M550d xDrive Touring																			
3.0 (280 kw)	2012.01-2017.02	8AT	F	L	Estate 4WD N57D30C		2015810L	Drive Shaft		37	27	65		562					
	2012.01-2017.02	8AT	F	R	Estate 4WD N57D30C		2016810L	Drive Shaft		37	27	65		864					
X1 sDrive 16d																			
2.0 (85 kw)	2012.07-2015.06	AT/MT	R	L	SUV RWD N47D20C		2051350L	Drive Shaft		30			73	618					
	2012.07-2015.06	AT/MT	R	R	SUV RWD N47D20C		2051340L	Drive Shaft		30			73	671					
X1 sDrive 18d																			
2.0 (100 kw)	2009.12-2015.06	AT/MT	R	L	SUV RWD N47D20C		2051350L	Drive Shaft		30			73	618					
	2009.12-2015.06	AT/MT	R	R	SUV RWD N47D20C		2051340L	Drive Shaft		30			73	671					
	2015.09-	8AT	F	L	SUV FWD B47C20A	Diameter:25mm	2021770L	Drive Shaft		31	28	56		538					
2.0 (105 kw)	2009.12-2015.06	AT/MT	R	L	SUV RWD N47D20C		2051350L	Drive Shaft		30			73	618					
	2009.12-2015.06	AT/MT	R	R	SUV RWD N47D20C		2051340L	Drive Shaft		30			73	671					
2.0 (110 kw)	2015.07-	8AT	F	L	SUV Van FWD B47C20A/B47C20B	For Engine Code:B47C20A	2021770L	Drive Shaft		31	28	56		538					
	2015.09-	8AT	F	L	SUV FWD B47C20A/B47C20B	For Engine Code:B47C20A	2021770L	Drive Shaft		31	28	56		538					
X1 sDrive 18i																			
1.5 (100 kw)	2015.11-	6AT	F	L	SUV FWD B38A15A		2037120L	Drive Shaft		31	26	56		541					
	2015.11-	6AT	F	R	SUV FWD B38A15A		2037130L	Drive Shaft		31	26	56		905					
	2015.11-	6MT	F	L	SUV FWD B38A15A		2026310L	Drive Shaft		31	34	56		563					
	2015.11-	6MT	F	R	SUV FWD B38A15A		2026320L	Drive Shaft		31	34	56		920					
1.5 (103 kw)	2017.06-	6MT	F	L	SUV FWD B38A15A		2026310L	Drive Shaft		31	34	56		563					
	2017.06-	6MT	F	R	SUV FWD B38A15A		2026320L	Drive Shaft		31	34	56		920					
	2017.07-	6MT	F	L	SUV Van FWD B38A15A		2026310L	Drive Shaft		31	34	56		563					
	2017.07-	6MT	F	R	SUV Van FWD B38A15A		2026320L	Drive Shaft		31	34	56		920					
X1 sDrive 20d																			
2.0 (120 kw)	2010.03-2015.06	AT/MT	R	L	SUV RWD N47D20C		2051350L	Drive Shaft		30			73	618					
	2010.03-2015.06	AT/MT	R	R	SUV RWD N47D20C		2051340L	Drive Shaft		30			73	671					
	2015.11-	8AT	F	L	SUV FWD B47C20A/B47C20B	For Engine Code:B47C20A,Diameter:25mm	2021770L	Drive Shaft		31	28	56		538					
2.0 (130 kw)	2009.10-2015.06	6AT/6MT	R	L	SUV RWD N47D20C		2051350L	Drive Shaft		30			73	618					
	2009.10-2015.06	6AT/6MT	R	R	SUV RWD N47D20C		2051340L	Drive Shaft		30			73	671					
2.0 (135 kw)	2012.07-2015.06	AT/MT	R	L	SUV RWD N47D20C		2051350L	Drive Shaft		30			73	618					
	2012.07-2015.06	AT/MT	R	R	SUV RWD N47D20C		2051340L	Drive Shaft		30			73	671					
2.0 (140 kw)	2015.11-	8AT	F	L	SUV FWD B47C20A/B47C20B	For Engine Code:B47C20A,Diameter:25mm	2021770L	Drive Shaft		31	28	56		538					
	2015.11-	8AT	F	L	SUV Van FWD B47C20A/B47C20B	For Engine Code:B47C20A,Diameter:25mm	2021770L	Drive Shaft		31	28	56		538					
X1 sDrive 20i																			
2.0 (141 kw)	2015.09-	8AT	F	L	SUV FWD B48A20A/B48A20F		2021770L	Drive Shaft		31	28	56		538					
	2017.07-	8AT	F	L	SUV Van FWD B48A20A		2021770L	Drive Shaft		31	28	56		538					
X1 xDrive 18d																			
2.0 (100 kw)	2009.12-2015.06	8AT/6MT	F	L	SUV 4WD N47D20C		2020580L	Drive Shaft		31	27	56.8		500					
	2009.12-2015.06	8AT/6MT	F	R	SUV 4WD N47D20C		2020590L	Drive Shaft		31	27	56.8		822					
	2009.12-2015.06	AT/MT	R	L	SUV 4WD N47D20C		2051350L	Drive Shaft		30			73	618					
	2009.12-2015.06	AT/MT	R	R	SUV 4WD N47D20C		2051340L	Drive Shaft		30			73	671					





	 YEAR	TRANSM.	F/R	L/R	BODY STYLE & DRIVE TYPE & ENGINE	REMARKS	GSP Ref.	 PRODUCT ABS	Technical Specifications				
									A	B	C	H	L
BMW													
X1 xDrive 18d													
2.0 (100 kw)	2015.11-	8AT	F	L	SUV 4WD B47C20A	Diameter:25mm	2021770L	Drive Shaft	31	28	56	538	
	2015.11-	8AT/6MT	F	R	SUV 4WD B47C20A		2026330L	Drive Shaft	31	35	56	499	
	2015.11-	8AT/6MT	R	L/R	SUV 4WD B47C20A		2021760L	Drive Shaft	31	27	56	731	
2.0 (105 kw)	2009.10-2015.06	6AT/8AT/6MT	F	L	SUV 4WD N47D20C		2020580L	Drive Shaft	31	27	56.8	500	
	2009.10-2015.06	6AT/8AT/6MT	F	R	SUV 4WD N47D20C		2020590L	Drive Shaft	31	27	56.8	822	
	2009.10-2015.06	AT/MT	R	L	SUV 4WD N47D20C		2051350L	Drive Shaft	30		73	618	
	2009.10-2015.06	AT/MT	R	R	SUV 4WD N47D20C		2051340L	Drive Shaft	30		73	671	
2.0 (110 kw)	2015.11-	6MT	F	R	SUV 4WD B47C20A/B47C20B		2026330L	Drive Shaft	31	35	56	499	
	2015.11-	8AT	F	L	SUV 4WD B47C20A/B47C20B	For Engine Code:B47C20A	2021770L	Drive Shaft	31	28	56	538	
	2015.11-	8AT	F	R	SUV 4WD B47C20A/B47C20B	For Engine Code:B47C20A	2026330L	Drive Shaft	31	35	56	499	
	2015.11-	8AT/6MT	R	L/R	SUV 4WD B47C20A/B47C20B		2021760L	Drive Shaft	31	27	56	731	
X1 xDrive 20d													
2.0 (120 kw)	2010.03-2015.06	6AT/6MT	F	L	SUV 4WD N47D20C		2020580L	Drive Shaft	31	27	56.8	500	
	2010.03-2015.06	6AT/6MT	F	R	SUV 4WD N47D20C		2020590L	Drive Shaft	31	27	56.8	822	
	2010.03-2015.06	AT/MT	R	L	SUV 4WD N47D20C		2051350L	Drive Shaft	30		73	618	
	2010.03-2015.06	AT/MT	R	R	SUV 4WD N47D20C		2051340L	Drive Shaft	30		73	671	
	2015.11-	6MT	F	R	SUV 4WD B47C20A/B47C20B		2026330L	Drive Shaft	31	35	56	499	
	2015.11-	8AT	F	L	SUV 4WD B47C20A/B47C20B	For Engine Code:B47C20A,Diameter:25mm	2021770L	Drive Shaft	31	28	56	538	
	2015.11-	8AT	F	R	SUV 4WD B47C20A/B47C20B	For Engine Code:B47C20A	2026330L	Drive Shaft	31	35	56	499	
	2015.11-	8AT/6MT	R	L/R	SUV 4WD B47C20A/B47C20B		2021760L	Drive Shaft	31	27	56	731	
2.0 (130 kw)	2009.10-2012.06	6AT/6MT	F	L	SUV 4WD N47D20C		2020580L	Drive Shaft	31	27	56.8	500	
	2009.10-2012.06	6AT/6MT	F	R	SUV 4WD N47D20C		2020590L	Drive Shaft	31	27	56.8	822	
	2009.10-2012.06	6AT/6MT	R	L	SUV 4WD N47D20C		2051350L	Drive Shaft	30		73	618	
	2009.10-2012.06	6AT/6MT	R	R	SUV 4WD N47D20C		2051340L	Drive Shaft	30		73	671	
2.0 (135 kw)	2012.07-2015.06	8AT/6MT	F	L	SUV 4WD N47D20C		2020580L	Drive Shaft	31	27	56.8	500	
	2012.07-2015.06	8AT/6MT	F	R	SUV 4WD N47D20C		2020590L	Drive Shaft	31	27	56.8	822	
	2012.07-2015.06	AT/MT	R	L	SUV 4WD N47D20C		2051350L	Drive Shaft	30		73	618	
	2012.07-2015.06	AT/MT	R	R	SUV 4WD N47D20C		2051340L	Drive Shaft	30		73	671	
2.0 (140 kw)	2015.11-	6MT	F	R	SUV 4WD B47C20A/B47C20B		2026330L	Drive Shaft	31	35	56	499	
	2015.11-	8AT	F	L	SUV 4WD B47C20A/B47C20B	For Engine Code:B47C20A	2021770L	Drive Shaft	31	28	56	538	
	2015.11-	8AT	F	R	SUV 4WD B47C20A/B47C20B	For Engine Code:B47C20A	2026330L	Drive Shaft	31	35	56	499	
	2015.11-	8AT/6MT	R	L/R	SUV 4WD B47C20A/B47C20B		2021760L	Drive Shaft	31	27	56	731	
	2015.11-	8AT	F	L	SUV Van 4WD B47C20A/B47C20B	For Engine Code:B47C20A,Diameter:25mm	2021770L	Drive Shaft	31	28	56	538	
	2015.11-	8AT	F	R	SUV Van 4WD B47C20A/B47C20B	For Engine Code:B47C20A	2026330L	Drive Shaft	31	35	56	499	
	2015.11-	8AT	R	L/R	SUV Van 4WD B47C20A/B47C20B	Diameter:24mm	2021760L	Drive Shaft	31	27	56	731	
X1 xDrive 20i													
2.0 (131 kw)	2020.11-	8AT	R	L/R	SUV 4WD B48A20A/B48A20F		2021760L	Drive Shaft	31	27	56	731	
2.0 (135 kw)	2011.09-2015.06	8AT/6MT	F	L	SUV 4WD N20B20A		2020580L	Drive Shaft	31	27	56.8	500	
	2011.09-2015.06	8AT/6MT	F	R	SUV 4WD N20B20A		2020590L	Drive Shaft	31	27	56.8	822	
	2011.09-2015.06	8AT	R	L	SUV 4WD N20B20A		2051350L	Drive Shaft	30		73	618	
	2011.09-2015.06	8AT	R	R	SUV 4WD N20B20A		2051340L	Drive Shaft	30		73	671	
2.0 (141 kw)	2015.07-	8AT	F	L	SUV 4WD B48A20A/B48A20B/B48A20F	Date To:2018.02	2021770L	Drive Shaft	31	28	56	538	
	2015.07-	8AT	F	R	SUV 4WD B48A20A/B48A20B/B48A20F	Date To:2018.02	2026330L	Drive Shaft	31	35	56	499	
	2015.07-	8AT	R	L/R	SUV 4WD B48A20A/B48A20B/B48A20F		2021760L	Drive Shaft	31	27	56	731	
X1 xDrive 23d													
2.0 (150 kw)	2009.09-2015.06	6AT/6MT	F	L	SUV 4WD N47D20D		2020580L	Drive Shaft	31	27	56.8	500	
	2009.09-2015.06	6AT/6MT	F	R	SUV 4WD N47D20D		2020590L	Drive Shaft	31	27	56.8	822	
	2009.09-2015.06	6AT	R	L	SUV 4WD N47D20D		2051350L	Drive Shaft	30		73	618	
	2009.09-2015.06	6AT	R	R	SUV 4WD N47D20D		2051340L	Drive Shaft	30		73	671	
X1 xDrive 25d													
2.0 (160 kw)	2012.07-2015.06	8AT/6MT	F	L	SUV 4WD N47D20D		2020580L	Drive Shaft	31	27	56.8	500	
	2012.07-2015.06	8AT/6MT	F	R	SUV 4WD N47D20D		2020590L	Drive Shaft	31	27	56.8	822	
	2012.07-2015.06	AT/MT	R	L	SUV 4WD N47D20D		2051350L	Drive Shaft	30		73	618	
	2012.07-2015.06	AT/MT	R	R	SUV 4WD N47D20D		2051340L	Drive Shaft	30		73	671	
2.0 (170 kw)	2015.09-	8AT	F	L	SUV 4WD B47C20B	Date To:2019.06,Diameter:25mm	2021770L	Drive Shaft	31	28	56	538	
	2015.09-	8AT	F	R	SUV 4WD B47C20B	Date To:2019.06	2026330L	Drive Shaft	31	35	56	499	
	2015.09-	8AT	R	L/R	SUV 4WD B47C20B		2021760L	Drive Shaft	31	27	56	731	
X1 xDrive 25i													
2.0 (170 kw)	2015.07-	8AT	F	L	SUV 4WD B46A20B/B48A20B	Date To:2017.10,Diameter:25mm	2021770L	Drive Shaft	31	28	56	538	
	2015.07-	8AT	F	R	SUV 4WD B46A20B/B48A20B	Date To:2017.10	2026330L	Drive Shaft	31	35	56	499	
	2015.07-	8AT	R	L/R	SUV 4WD B46A20B/B48A20B		2021760L	Drive Shaft	31	27	56	731	
3.0 (160 kw)	2010.03-2011.08	6AT/6MT	F	L	SUV 4WD N52B30A		2020580L	Drive Shaft	31	27	56.8	500	
	2010.03-2011.08	6AT/6MT	F	R	SUV 4WD N52B30A		2020590L	Drive Shaft	31	27	56.8	822	



	 YEAR	TRANSM.	F/R	L/R	BODY STYLE & DRIVE TYPE & ENGINE	REMARKS	GSP Ref.	 PRODUCT	 ABS	Technical Specifications					
										A	B	C	H	L	
BMW															
X1 xDrive 28i															
2.0 (180 kw)	2011.03-2015.06	8AT/6MT	F	L	SUV 4WD N20B20A		2020580L	Drive Shaft		31	27	56.8		500	
	2011.03-2015.06	8AT/6MT	F	R	SUV 4WD N20B20A		2020590L	Drive Shaft		31	27	56.8		822	
	2011.03-2015.06	AT/MT	R	L	SUV 4WD N20B20A		2051350L	Drive Shaft		30			73	618	
	2011.03-2015.06	AT/MT	R	R	SUV 4WD N20B20A		2051340L	Drive Shaft		30			73	671	
	2011.04-2015.06	AT/MT	R	L	SUV 4WD N20B20A		2051350L	Drive Shaft		30			73	618	
3.0 (190 kw)	2009.09-2011.08	6AT/6MT	F	L	SUV 4WD N52B30A		2020580L	Drive Shaft		31	27	56.8		500	
	2009.09-2011.08	6AT/6MT	F	R	SUV 4WD N52B30A		2020590L	Drive Shaft		31	27	56.8		822	
3.0 (194 kw)	2010.03-2011.06	6AT	F	L	SUV 4WD N52B30A		2020580L	Drive Shaft		31	27	56.8		500	
	2010.03-2011.06	6AT	F	R	SUV 4WD N52B30A		2020590L	Drive Shaft		31	27	56.8		822	
X2 sDrive 18d															
2.0 (100 kw)	2018.03-	8AT	F	L	SUV FWD B47C20A/B47C20B	Diameter:25mm	2021770L	Drive Shaft		31	28	56		538	
2.0 (110 kw)	2018.03-	8AT	F	L	SUV FWD B47C20A/B47C20B		2021770L	Drive Shaft		31	28	56		538	
X2 sDrive 18i															
1.5 (100 kw)	2018.03-	6AT	F	L	SUV FWD B32S15A/B38A15A	Diameter:25mm	2021770L	Drive Shaft		31	28	56		538	
	2018.03-	6AT	F	R	SUV FWD B32S15A/B38A15A		2037130L	Drive Shaft		31	26	56		905	
	2018.03-	6MT	F	L	SUV FWD B32S15A/B38A15A		2026310L	Drive Shaft		31	34	56		563	
	2018.03-	6MT	F	R	SUV FWD B32S15A/B38A15A		2026320L	Drive Shaft		31	34	56		920	
1.5 (103 kw)	2018.03-	6MT	F	L	SUV FWD B38A15A		2026310L	Drive Shaft		31	34	56		563	
	2018.03-	6MT	F	R	SUV FWD B38A15A		2026320L	Drive Shaft		31	34	56		920	
X2 sDrive 20d															
2.0 (120 kw)	2018.11-	8AT	F	L	SUV FWD B47C20A/B47C20B	For Engine Code:B47C20A,Diameter:25mm	2021770L	Drive Shaft		31	28	56		538	
2.0 (140 kw)	2018.11-	8AT	F	L	SUV FWD B47C20A/B47C20B	For Engine Code:B47C20A,Diameter:25mm	2021770L	Drive Shaft		31	28	56		538	
X2 sDrive 20i															
2.0 (141 kw)	2017.11-	8AT	F	L	SUV FWD B42S20A/B48A20A		2021770L	Drive Shaft		31	28	56		538	
X2 xDrive 18d															
2.0 (100 kw)	2018.03-	6MT	F	R	SUV 4WD B47C20B		2026330L	Drive Shaft		31	35	56		499	
	2018.03-	6MT	R	L/R	SUV 4WD B47C20B		2021760L	Drive Shaft		31	27	56		731	
2.0 (110 kw)	2018.03-	8AT	F	L	SUV 4WD B47C20B	Diameter:25mm	2021770L	Drive Shaft		31	28	56		538	
	2018.03-	8AT/6MT	F	R	SUV 4WD B47C20B		2026330L	Drive Shaft		31	35	56		499	
	2018.03-	8AT/6MT	R	L/R	SUV 4WD B47C20B		2021760L	Drive Shaft		31	27	56		731	
X2 xDrive 20d															
2.0 (120 kw)	2017.11-	8AT	F	L	SUV 4WD B47C20A	Diameter:25mm	2021770L	Drive Shaft		31	28	56		538	
	2017.11-	8AT	F	R	SUV 4WD B47C20A		2026330L	Drive Shaft		31	35	56		499	
	2017.11-	8AT	R	L/R	SUV 4WD B47C20A		2021760L	Drive Shaft		31	27	56		731	
2.0 (140 kw)	2017.11-	8AT	F	L	SUV 4WD B47C20A/B47C20B	Diameter:25mm	2021770L	Drive Shaft		31	28	56		538	
	2017.11-	8AT	F	R	SUV 4WD B47C20A/B47C20B		2026330L	Drive Shaft		31	35	56		499	
	2017.11-	8AT	R	L/R	SUV 4WD B47C20A/B47C20B		2021760L	Drive Shaft		31	27	56		731	
X2 xDrive 20i															
2.0 (131 kw)	2020.11-	8AT	F	L	SUV 4WD B48A20A	Diameter:25mm	2021770L	Drive Shaft		31	28	56		538	
	2020.11-	8AT	R	L/R	SUV 4WD B48A20A	Diameter:24mm	2021760L	Drive Shaft		31	27	56		731	
2.0 (141 kw)	2018.03-2020.10	8AT	F	L	SUV 4WD B48A20A	Diameter:25mm	2021770L	Drive Shaft		31	28	56		538	
	2018.03-2020.10	8AT	F	R	SUV 4WD B48A20A		2026330L	Drive Shaft		31	35	56		499	
	2018.03-2020.10	8AT	R	L/R	SUV 4WD B48A20A		2021760L	Drive Shaft		31	27	56		731	
X2 xDrive 25d															
2.0 (170 kw)	2017.11-	8AT	F	L	SUV 4WD B47C20B	Diameter:25mm	2021770L	Drive Shaft		31	28	56		538	
	2017.11-	8AT	F	R	SUV 4WD B47C20B		2026330L	Drive Shaft		31	35	56		499	
	2017.11-	8AT	R	L/R	SUV 4WD B47C20B		2021760L	Drive Shaft		31	27	56		731	
X2 xDrive M35i															
2.0 (225 kw)	2018.11-	8AT	F	R	SUV 4WD B48A20E		2026330L	Drive Shaft		31	35	56		499	
	2018.11-	8AT	R	L/R	SUV 4WD B48A20E		2021760L	Drive Shaft		31	27	56		731	
X3 sDrive 20i															
1.6 (125 kw)	2014.04-2017.08	8AT	R	L	SUV RWD N20B16A		2051170L	Drive Shaft		30	27		77	769	
	2014.04-2017.08	8AT	R	R	SUV RWD N20B16A		2051210L	Drive Shaft		30	27		77	825	
2.0 (135 kw)	2014.04-2017.08	8AT	R	L	SUV RWD N20B20A		2051170L	Drive Shaft		30	27		77	769	
	2014.04-2017.08	8AT	R	R	SUV RWD N20B20A		2051210L	Drive Shaft		30	27		77	825	
X3 sDrive 20d															
2.0 (120 kw)	2010.09-2014.03	8AT/6MT	F	L	SUV 4WD N47D20C		2020600L	Drive Shaft		37	27	65		590	
	2010.09-2014.03	8AT/6MT	F	R	SUV 4WD N47D20C		2020610L	Drive Shaft		37	27	65		880	
	2010.09-2014.03	6MT	R	L	SUV 4WD N47D20C		2051170L	Drive Shaft		30	27		77	769	
	2010.09-2014.03	8AT/6MT	R	R	SUV 4WD N47D20C		2051210L	Drive Shaft		30	27		77	825	
	2.0 (135 kw)	2010.09-2014.03	8AT/6MT	F	L	SUV 4WD N47D20C		2020600L	Drive Shaft		37	27	65		590
		2010.09-2014.03	8AT/6MT	F	R	SUV 4WD N47D20C		2020610L	Drive Shaft		37	27	65		880
2010.09-2014.03		6MT	R	L	SUV 4WD N47D20C		2051170L	Drive Shaft		30	27		77	769	
2.0 (140 kw)	2010.09-2014.03	8AT/6MT	R	R	SUV 4WD N47D20C		2051210L	Drive Shaft		30	27		77	825	
	2014.04-2017.08	8AT/6MT	F	L	SUV 4WD B47D20A		2020600L	Drive Shaft		37	27	65		590	



		TRANSM.	F/R	L/R	BODY STYLE & DRIVE TYPE & ENGINE	REMARKS	GSP Ref.		PRODUCT ABS	Technical Specifications				
										A	B	C	H	L
BMW														
X3 xDrive 20d														
2.0 (140 kw)	2014.04-2017.08	8AT/6MT	F	R	SUV 4WD B47D20A		2020610L	Drive Shaft		37	27	65		880
	2014.04-2017.08	AT/MT	R	L	SUV 4WD B47D20A		2051170L	Drive Shaft		30	27		77	769
	2014.04-2017.08	AT/MT	R	R	SUV 4WD B47D20A		2051210L	Drive Shaft		30	27		77	825
X3 xDrive 20i														
2.0 (135 kw)	2011.10-2017.08	8AT/6MT	F	L	SUV 4WD N20B20A		2020600L	Drive Shaft		37	27	65		590
	2011.10-2017.08	8AT/6MT	F	R	SUV 4WD N20B20A		2020610L	Drive Shaft		37	27	65		880
	2011.10-2017.08	8AT/6MT	R	L	SUV 4WD N20B20A		2051170L	Drive Shaft		30	27		77	769
	2011.10-2017.08	8AT/6MT	R	R	SUV 4WD N20B20A		2051210L	Drive Shaft		30	27		77	825
X3 xDrive 28i														
2.0 (180 kw)	2012.04-2017.08	8AT	F	L	SUV 4WD N20B20A		2020600L	Drive Shaft		37	27	65		590
	2012.04-2017.08	8AT	F	R	SUV 4WD N20B20A		2020610L	Drive Shaft		37	27	65		880
	2012.04-2017.08	8AT	R	L	SUV 4WD N20B20A		2051170L	Drive Shaft		30	27		77	769
	2012.04-2017.08	8AT	R	R	SUV 4WD N20B20A		2051210L	Drive Shaft		30	27		77	825
3.0 (190 kw)	2011.01-2012.10	8AT	F	L	SUV 4WD N52B30A/N52B30AF/N52B30BF		2020600L	Drive Shaft		37	27	65		590
	2011.01-2012.10	8AT	F	R	SUV 4WD N52B30A/N52B30AF/N52B30BF		2020610L	Drive Shaft		37	27	65		880
	2011.01-2012.10	6AT/8AT	R	L	SUV 4WD N52B30A/N52B30AF/N52B30BF		2051170L	Drive Shaft		30	27		77	769
	2011.01-2012.10	6AT/8AT	R	R	SUV 4WD N52B30A/N52B30AF/N52B30BF		2051210L	Drive Shaft		30	27		77	825
X3 xDrive 30d														
3.0 (155 kw)	2011.04-2017.08	8AT	F	L	SUV 4WD N57D30A		2020600L	Drive Shaft		37	27	65		590
	2011.04-2017.08	8AT	F	R	SUV 4WD N57D30A		2020610L	Drive Shaft		37	27	65		880
	2011.04-2017.08	8AT	R	L	SUV 4WD N57D30A		2051200L	Drive Shaft		30	32		77	776
	2011.04-2017.08	8AT	R	R	SUV 4WD N57D30A		2051190L	Drive Shaft		30	32		77	830
3.0 (183 kw)	2011.06-2017.08	8AT	F	L	SUV 4WD N57D30A		2020600L	Drive Shaft		37	27	65		590
	2011.06-2017.08	8AT	F	R	SUV 4WD N57D30A		2020610L	Drive Shaft		37	27	65		880
	2011.06-2017.08	8AT	R	L	SUV 4WD N57D30A		2051200L	Drive Shaft		30	32		77	776
	2011.06-2017.08	8AT	R	R	SUV 4WD N57D30A		2051190L	Drive Shaft		30	32		77	830
3.0 (190 kw)	2011.04-2017.08	8AT	F	L	SUV 4WD N57D30A		2020600L	Drive Shaft		37	27	65		590
	2011.04-2017.08	8AT	F	R	SUV 4WD N57D30A		2020610L	Drive Shaft		37	27	65		880
	2011.04-2017.08	8AT	R	L	SUV 4WD N57D30A		2051200L	Drive Shaft		30	32		77	776
	2011.04-2017.08	8AT	R	R	SUV 4WD N57D30A		2051190L	Drive Shaft		30	32		77	830
3.0 (204 kw)	2016.06-2017.08	8AT	F	L	SUV 4WD N57D30A		2020600L	Drive Shaft		37	27	65		590
	2016.06-2017.08	8AT	F	R	SUV 4WD N57D30A		2020610L	Drive Shaft		37	27	65		880
	2016.06-2017.08	8AT	R	L	SUV 4WD N57D30A		2051200L	Drive Shaft		30	32		77	776
	2016.06-2017.08	8AT	R	R	SUV 4WD N57D30A		2051190L	Drive Shaft		30	32		77	830
3.0 (210 kw)	2011.04-2016.05	8AT	F	L	SUV 4WD N57D30A		2020600L	Drive Shaft		37	27	65		590
	2011.04-2016.05	8AT	F	R	SUV 4WD N57D30A		2020610L	Drive Shaft		37	27	65		880
	2011.04-2016.05	8AT	R	L	SUV 4WD N57D30A		2051200L	Drive Shaft		30	32		77	776
	2011.04-2016.05	8AT	R	R	SUV 4WD N57D30A		2051190L	Drive Shaft		30	32		77	830
X3 xDrive 35d														
3.0 (230 kw)	2011.10-2017.08	8AT	F	L	SUV 4WD N57D30B		2020600L	Drive Shaft		37	27	65		590
	2011.10-2017.08	8AT	F	R	SUV 4WD N57D30B		2020610L	Drive Shaft		37	27	65		880
	2011.10-2017.08	8AT	R	L	SUV 4WD N57D30B		2051200L	Drive Shaft		30	32		77	776
	2011.10-2017.08	8AT	R	R	SUV 4WD N57D30B		2051190L	Drive Shaft		30	32		77	830
X3 xDrive 35i														
3.0 (225 kw)	2010.09-2017.08	8AT	F	L	SUV 4WD N55B30A		2020600L	Drive Shaft		37	27	65		590
	2010.09-2017.08	8AT	F	R	SUV 4WD N55B30A		2020610L	Drive Shaft		37	27	65		880
	2010.09-2017.08	8AT	R	L	SUV 4WD N55B30A		2051170L	Drive Shaft		30	27		77	769
	2010.09-2017.08	8AT	R	R	SUV 4WD N55B30A		2051210L	Drive Shaft		30	27		77	825
X4 xDrive 20d														
2.0 (120 kw)	2014.04-2018.03	AT/MT	F	L	SUV 4WD B47D20A		2020600L	Drive Shaft		37	27	65		590
	2014.04-2018.03	AT/MT	F	R	SUV 4WD B47D20A		2020610L	Drive Shaft		37	27	65		880
	2014.04-2018.03	AT/MT	R	L	SUV 4WD B47D20A		2051170L	Drive Shaft		30	27		77	769
	2014.04-2018.03	AT/MT	R	R	SUV 4WD B47D20A		2051210L	Drive Shaft		30	27		77	825
2.0 (140 kw)	2014.04-2018.03	AT/MT	F	L	SUV 4WD B47D20A		2020600L	Drive Shaft		37	27	65		590
	2014.04-2018.03	AT/MT	F	R	SUV 4WD B47D20A		2020610L	Drive Shaft		37	27	65		880
	2014.04-2018.03	AT/MT	R	L	SUV 4WD B47D20A		2051170L	Drive Shaft		30	27		77	769
	2014.04-2018.03	AT/MT	R	R	SUV 4WD B47D20A		2051210L	Drive Shaft		30	27		77	825
X4 xDrive 20i														
2.0 (135 kw)	2014.04-2018.03	AT	F	L	SUV 4WD N20B20A		2020600L	Drive Shaft		37	27	65		590
	2014.04-2018.03	AT	F	R	SUV 4WD N20B20A		2020610L	Drive Shaft		37	27	65		880
	2014.04-2018.03	AT	R	L	SUV 4WD N20B20A		2051170L	Drive Shaft		30	27		77	769
	2014.04-2018.03	AT	R	R	SUV 4WD N20B20A		2051210L	Drive Shaft		30	27		77	825
X4 xDrive 28i														
2.0 (180 kw)	2014.04-2018.03	AT/MT	F	L	SUV 4WD N20B20A		2020600L	Drive Shaft		37	27	65		590
	2014.04-2018.03	AT/MT	F	R	SUV 4WD N20B20A		2020610L	Drive Shaft		37	27	65		880





	 YEAR	TRANSM.	F/R	L/R	BODY STYLE & DRIVE TYPE & ENGINE	REMARKS	GSP Ref.	 PRODUCT	ABS	Technical Specifications				
										A	B	C	H	L
BMW														
X4 xDrive 28i														
2.0 (180 kw)	2014.04-2018.03	AT	R	L	SUV 4WD N20B20A		2051170L	Drive Shaft		30	27		77	769
	2014.04-2018.03	AT	R	R	SUV 4WD N20B20A		2051210L	Drive Shaft		30	27		77	825
X4 xDrive 30d														
3.0 (155 kw)	2014.04-2018.03	AT	F	L	SUV 4WD N57D30A		2020600L	Drive Shaft		37	27	65		590
	2014.04-2018.03	AT	F	R	SUV 4WD N57D30A		2020610L	Drive Shaft		37	27	65		880
	2014.04-2018.03	AT	R	L	SUV 4WD N57D30A		2051200L	Drive Shaft		30	32		77	776
	2014.04-2018.03	AT	R	R	SUV 4WD N57D30A		2051190L	Drive Shaft		30	32		77	830
3.0 (183 kw)	2015.04-2018.03	AT	F	L	SUV 4WD N57D30A		2020600L	Drive Shaft		37	27	65		590
	2015.04-2018.03	AT	F	R	SUV 4WD N57D30A		2020610L	Drive Shaft		37	27	65		880
	2015.04-2018.03	AT	R	L	SUV 4WD N57D30A		2051200L	Drive Shaft		30	32		77	776
	2015.04-2018.03	AT	R	R	SUV 4WD N57D30A		2051190L	Drive Shaft		30	32		77	830
3.0 (190 kw)	2014.04-2018.03	AT	F	L	SUV 4WD N57D30A		2020600L	Drive Shaft		37	27	65		590
	2014.04-2018.03	AT	F	R	SUV 4WD N57D30A		2020610L	Drive Shaft		37	27	65		880
	2014.04-2018.03	AT	R	L	SUV 4WD N57D30A	For vehicles without towbar	2051200L	Drive Shaft		30	32		77	776
	2014.04-2018.03	AT	R	R	SUV 4WD N57D30A	For vehicles without towbar	2051190L	Drive Shaft		30	32		77	830
3.0 (204 kw)	2014.04-2018.03	8AT	F	L	SUV 4WD N57D30A		2020600L	Drive Shaft		37	27	65		590
	2014.04-2018.03	8AT	F	R	SUV 4WD N57D30A		2020610L	Drive Shaft		37	27	65		880
	2014.04-2018.03	8AT	R	L	SUV 4WD N57D30A		2051200L	Drive Shaft		30	32		77	776
	2014.04-2018.03	8AT	R	R	SUV 4WD N57D30A		2051190L	Drive Shaft		30	32		77	830
3.0 (210 kw)	2014.04-2018.03	AT	F	L	SUV 4WD N57D30A		2020600L	Drive Shaft		37	27	65		590
	2014.04-2018.03	AT	F	R	SUV 4WD N57D30A		2020610L	Drive Shaft		37	27	65		880
	2014.04-2018.03	AT	R	L	SUV 4WD N57D30A		2051200L	Drive Shaft		30	32		77	776
	2014.04-2018.03	AT	R	R	SUV 4WD N57D30A		2051190L	Drive Shaft		30	32		77	830
X4 xDrive 35d														
3.0 (230 kw)	2014.04-2018.03	AT	F	L	SUV 4WD N57D30B		2020600L	Drive Shaft		37	27	65		590
	2014.04-2018.03	AT	F	R	SUV 4WD N57D30B		2020610L	Drive Shaft		37	27	65		880
	2014.04-2018.03	AT	R	L	SUV 4WD N57D30B		2051200L	Drive Shaft		30	32		77	776
	2014.04-2018.03	AT	R	R	SUV 4WD N57D30B		2051190L	Drive Shaft		30	32		77	830
X4 xDrive 35i														
3.0 (225 kw)	2014.04-2018.03	AT	F	L	SUV 4WD N55B30A		2020600L	Drive Shaft		37	27	65		590
	2014.04-2018.03	AT	F	R	SUV 4WD N55B30A		2020610L	Drive Shaft		37	27	65		880
X4 xDrive M40i														
3.0 (265 kw)	2015.12-2018.03	AT	F	L	SUV 4WD N55B30A		2020600L	Drive Shaft		37	27	65		590
	2015.12-2018.03	AT	F	R	SUV 4WD N55B30A		2020610L	Drive Shaft		37	27	65		880
X5														
3.0 (155 kw)	2006.12-2008.09	6AT	F	L	SUV 4WD M57D306D3		2050520L	Drive Shaft		30	27	64.5	86.5	636
	2006.12-2008.09	6AT	F	R	SUV 4WD M57D306D3		2050430L	Drive Shaft		30	27	64.5	86.5	1023
	2006.12-2008.09	6AT	R	L/R	SUV 4WD M57D306D3	For vehicles with towbar	2050700L	Drive Shaft		30	32	68.7	84	810
	2006.12-2008.09	6AT	R	L/R	SUV 4WD M57D306D3	For vehicles without towbar	2050810L	Drive Shaft		30	27	68.7	84	810
3.0 (173 kw)	2007.02-2008.09	6AT	F	L	SUV 4WD M57D306D3		2050520L	Drive Shaft		30	27	64.5	86.5	636
	2007.02-2008.09	6AT	F	R	SUV 4WD M57D306D3		2050430L	Drive Shaft		30	27	64.5	86.5	1023
	2007.02-2008.09	6AT	R	L/R	SUV 4WD M57D306D3	For vehicles with towbar	2050700L	Drive Shaft		30	32	68.7	84	810
	2007.02-2008.09	6AT	R	L/R	SUV 4WD M57D306D3	For vehicles without towbar;Inner teeth of wheel side:29	2050810L	Drive Shaft		30	27	68.7	84	810
3.0 (200 kw)	2006.10-2008.09	AT	F	L	SUV 4WD N52B30A/N52B30AF/N52B30BF		2050520L	Drive Shaft		30	27	64.5	86.5	636
	2006.10-2008.09	AT	F	R	SUV 4WD N52B30A/N52B30AF/N52B30BF		2050430L	Drive Shaft		30	27	64.5	86.5	1023
	2006.10-2008.09	AT	R	L/R	SUV 4WD N52B30A/N52B30AF/N52B30BF		2050810L	Drive Shaft		30	27	68.7	84	810
3.0 (210 kw)	2007.10-2008.09	6AT	F	L	SUV 4WD M57D306D5		2050520L	Drive Shaft		30	27	64.5	86.5	636
	2007.10-2008.09	6AT	F	R	SUV 4WD M57D306D5		2050430L	Drive Shaft		30	27	64.5	86.5	1023
	2007.10-2008.09	6AT	R	L/R	SUV 4WD M57D306D5		2050700L	Drive Shaft		30	32	68.7	84	810
4.8 (261 kw)	2006.10-2008.09	AT	F	L	SUV 4WD N62B48B		2050520L	Drive Shaft		30	27	64.5	86.5	636
	2006.10-2008.09	AT	F	R	SUV 4WD N62B48B		2050430L	Drive Shaft		30	27	64.5	86.5	1023
	2006.10-2008.09	6AT	R	L/R	SUV 4WD N62B48B	For vehicles with towbar	2050700L	Drive Shaft		30	32	68.7	84	810
	2006.10-2008.09	6AT	R	L/R	SUV 4WD N62B48B	For vehicles without towbar	2050810L	Drive Shaft		30	27	68.7	84	810
X5 M														
4.4 (408 kw)	2009.07-2013.07	6AT	F	L	SUV 4WD S63B44A		2050520L	Drive Shaft		30	27	64.5	86.5	636
	2009.07-2013.07	6AT	F	R	SUV 4WD S63B44A		2050430L	Drive Shaft		30	27	64.5	86.5	1023
4.4 (423 kw)	2014.12-2018.07	AT	F	R	SUV 4WD S63B44B		2050430L	Drive Shaft		30	27	64.5	86.5	1023
X5 xDrive 25d														
2.0 (155 kw)	2013.12-2015.07	8AT	F	L	SUV 4WD N47D20D		2011100L	Drive Shaft		30	27	64.5	86.5	660
	2013.12-2015.07	8AT	F	R	SUV 4WD N47D20D		2051230L	Drive Shaft		30	27	64.5	86.5	973
2.0 (160 kw)	2013.12-2015.07	8AT	F	L	SUV 4WD N47D20D		2011100L	Drive Shaft		30	27	64.5	86.5	660
	2013.12-2015.07	8AT	F	R	SUV 4WD N47D20D		2051230L	Drive Shaft		30	27	64.5	86.5	973
2.0 (170 kw)	2015.08-2018.07	8AT	F	L	SUV 4WD B47D20B		2011100L	Drive Shaft		30	27	64.5	86.5	660
	2015.08-2018.07	8AT	F	R	SUV 4WD B47D20B		2051230L	Drive Shaft		30	27	64.5	86.5	973
3.0 (160 kw)	2015.06-2018.07	8AT	F	L	SUV 4WD N57D30A		2011100L	Drive Shaft		30	27	64.5	86.5	660





  YEAR	TRANSM.	F/R	L/R	BODY STYLE & DRIVE TYPE & ENGINE	REMARKS	GSP Ref.	 PRODUCT	 ABS	Technical Specifications					
									A	B	C	H	L	
BMW														
X5 xDrive 25d														
3.0 (160 kw)	2015.06-2018.07	8AT	F	R	SUV 4WD N57D30A		2051230L	Drive Shaft		30	27	64.5	86.5	973
	2015.06-2018.07	AT	R	L/R	SUV 4WD N57D30A	For vehicles without electronic suspension control.For vehicles with towbar	2050700L	Drive Shaft		30	32	68.7	84	810
	2015.06-2018.07	AT	R	L/R	SUV 4WD N57D30A	For vehicles without electronic suspension control.For vehicles without towbar	2050810L	Drive Shaft		30	27	68.7	84	810
	2015.06-2018.07	AT	R	L/R	SUV 4WD N57D30A	For vehicles with Adaptive suspension	2051490L	Drive Shaft		30			84.5	630
X5 xDrive 28i														
2.0 (180 kw)	2015.06-2018.07	8AT	F	L	SUV 4WD N20B20A		2011100L	Drive Shaft		30	27	64.5	86.5	660
	2015.06-2018.07	8AT	F	R	SUV 4WD N20B20A		2051230L	Drive Shaft		30	27	64.5	86.5	973
	2015.06-2018.07	8AT	R	L/R	SUV 4WD N20B20A	Outer teeth of transm.side:32:For vehicles with towbar	2050700L	Drive Shaft		30	32	68.7	84	810
	2015.06-2018.07	8AT	R	L/R	SUV 4WD N20B20A	Outer teeth of transm.side:27	2050810L	Drive Shaft		30	27	68.7	84	810
X5 xDrive 30d														
3.0 (155 kw)	2008.10-2013.07	6AT/8AT	F	L	SUV 4WD M57D306D3/N57D30A		2011100L	Drive Shaft		30	27	64.5	86.5	660
	2008.10-2013.07	6AT/8AT	F	L	SUV 4WD M57D306D3/N57D30A		2050520L	Drive Shaft		30	27	64.5	86.5	636
	2008.10-2013.07	6AT/8AT	F	R	SUV 4WD M57D306D3/N57D30A		2050430L	Drive Shaft		30	27	64.5	86.5	1023
	2008.10-2013.07		F	R	SUV 4WD M57D306D3/N57D30A		2051230L	Drive Shaft		30	27	64.5	86.5	973
	2008.10-2013.07	6AT/8AT	R	L/R	SUV 4WD M57D306D3/N57D30A	Outer teeth of transm.side:27	2050810L	Drive Shaft		30	27	68.7	84	810
	2008.10-2013.07	8AT	R	L/R	SUV 4WD M57D306D3/N57D30A	Outer teeth of transm.side:32	2050700L	Drive Shaft		30	32	68.7	84	810
3.0 (173 kw)	2008.10-2010.03	6AT	F	L	SUV 4WD M57D306D3		2050520L	Drive Shaft		30	27	64.5	86.5	636
	2008.10-2010.03	6AT	F	R	SUV 4WD M57D306D3		2050430L	Drive Shaft		30	27	64.5	86.5	1023
	2008.10-2010.03	6AT	R/L/R	SUV 4WD M57D306D3	For reinforced version		2050700L	Drive Shaft		30	32	68.7	84	810
	2008.10-2010.03	6AT	R	L/R	SUV 4WD M57D306D3	Not for reinforced version	2050810L	Drive Shaft		30	27	68.7	84	810
3.0 (180 kw)	2010.04-2013.07	8AT	F	L	SUV 4WD N57D30A		2011100L	Drive Shaft		30	27	64.5	86.5	660
	2010.04-2013.07	8AT	F	R	SUV 4WD N57D30A		2051230L	Drive Shaft		30	27	64.5	86.5	973
	2010.04-2013.07	8AT	R	L/R	SUV 4WD N57D30A	For vehicles with towbar	2050700L	Drive Shaft		30	32	68.7	84	810
	2010.04-2013.07	8AT	R	L/R	SUV 4WD N57D30A	For vehicles without towbar	2050810L	Drive Shaft		30	27	68.7	84	810
3.0 (183 kw)	2013.12-2018.07	8AT	F	L	SUV 4WD N57D30A		2011100L	Drive Shaft		30	27	64.5	86.5	660
	2013.12-2018.07	8AT	F	R	SUV 4WD N57D30A		2051230L	Drive Shaft		30	27	64.5	86.5	973
	2013.12-2018.07	8AT	R	L/R	SUV 4WD N57D30A	For vehicles without electronic suspension control.For vehicles with towbar	2050700L	Drive Shaft		30	32	68.7	84	810
	2013.12-2018.07	8AT	R	L/R	SUV 4WD N57D30A	For vehicles without electronic suspension control.For vehicles without towbar	2050810L	Drive Shaft		30	27	68.7	84	810
	2013.12-2018.07	8AT	R	L/R	SUV 4WD N57D30A	For vehicles with Adaptive suspension	2051490L	Drive Shaft		30			84.5	630
3.0 (190 kw)	2013.08-2018.07	8AT	F	L	SUV 4WD N57D30A		2011100L	Drive Shaft		30	27	64.5	86.5	660
	2013.08-2018.07	8AT	F	R	SUV 4WD N57D30A		2051230L	Drive Shaft		30	27	64.5	86.5	973
	2013.08-2018.07	8AT	R	L/R	SUV 4WD N57D30A	For vehicles without electronic suspension control.For vehicles with towbar	2050700L	Drive Shaft		30	32	68.7	84	810
	2013.08-2018.07	8AT	R	L/R	SUV 4WD N57D30A	For vehicles without electronic suspension control.For vehicles without towbar	2050810L	Drive Shaft		30	27	68.7	84	810
	2013.08-2018.07	8AT	R	L/R	SUV 4WD N57D30A	For vehicles with electronic suspension control.For vehicles without towbar	2051490L	Drive Shaft		30			84.5	630
3.0 (204 kw)	2013.08-2018.07	8AT	F	L	SUV 4WD N57D30A		2011100L	Drive Shaft		30	27	64.5	86.5	660
	2013.08-2018.07	8AT	F	R	SUV 4WD N57D30A		2051230L	Drive Shaft		30	27	64.5	86.5	973
	2013.08-2018.07	8AT	R	L/R	SUV 4WD N57D30A	For vehicles without electronic suspension control.For vehicles with towbar	2050700L	Drive Shaft		30	32	68.7	84	810
	2013.08-2018.07	8AT	R	L/R	SUV 4WD N57D30A	For vehicles without electronic suspension control.For vehicles without towbar	2050810L	Drive Shaft		30	27	68.7	84	810
	2013.08-2018.07	8AT	R	L/R	SUV 4WD N57D30A	For vehicles with Adaptive suspension	2051490L	Drive Shaft		30			84.5	630
3.0 (210 kw)	2013.08-2018.07	8AT	F	L	SUV 4WD N57D30A		2011100L	Drive Shaft		30	27	64.5	86.5	660
	2013.08-2018.07	8AT	F	R	SUV 4WD N57D30A		2051230L	Drive Shaft		30	27	64.5	86.5	973
	2013.08-2018.07	8AT	R	L/R	SUV 4WD N57D30A	For vehicles without electronic suspension control.For vehicles with towbar	2050700L	Drive Shaft		30	32	68.7	84	810
	2013.08-2018.07	8AT	R	L/R	SUV 4WD N57D30A	For vehicles without electronic suspension control.For vehicles without towbar	2050810L	Drive Shaft		30	27	68.7	84	810
	2013.08-2018.07	8AT	R	L/R	SUV 4WD N57D30A	For vehicles with Adaptive suspension	2051490L	Drive Shaft		30			84.5	630
X5 xDrive 30i														
3.0 (172 kw)	2007.02-2010.12	6AT	F	L	SUV 4WD N52B30A		2050520L	Drive Shaft		30	27	64.5	86.5	636
	2007.02-2010.12	6AT	F	R	SUV 4WD N52B30A		2050430L	Drive Shaft		30	27	64.5	86.5	1023
	2007.02-2010.12	6AT	R	L/R	SUV 4WD N52B30A		2050810L	Drive Shaft		30	27	68.7	84	810
3.0 (200 kw)	2008.10-2010.03	6AT	F	L	SUV 4WD N52B30A		2050520L	Drive Shaft		30	27	64.5	86.5	636
	2008.10-2010.03	6AT	F	R	SUV 4WD N52B30A		2050430L	Drive Shaft		30	27	64.5	86.5	1023
	2008.10-2010.03	6AT	R	L/R	SUV 4WD N52B30A		2050810L	Drive Shaft		30	27	68.7	84	810
X5 xDrive 35d														
3.0 (210 kw)	2008.10-2010.03	6AT	F	L	SUV 4WD M57D306D5		2050520L	Drive Shaft		30	27	64.5	86.5	636
	2008.10-2010.03	6AT	F	R	SUV 4WD M57D306D5		2050430L	Drive Shaft		30	27	64.5	86.5	1023
	2008.10-2010.03	6AT	R	L/R	SUV 4WD M57D306D5		2050700L	Drive Shaft		30	32	68.7	84	810
X5 xDrive 35i														
3.0 (225 kw)	2010.04-2013.07	8AT	F	L	SUV 4WD N55B30A		2050520L	Drive Shaft		30	27	64.5	86.5	636
	2010.04-2013.07	8AT	F	R	SUV 4WD N55B30A		2050430L	Drive Shaft		30	27	64.5	86.5	1023
	2010.04-2013.07	8AT	R	L/R	SUV 4WD N55B30A	for reinforced version	2050700L	Drive Shaft		30	32	68.7	84	810
	2010.04-2013.07	8AT	R	L/R	SUV 4WD N55B30A	not for reinforced version	2050810L	Drive Shaft		30	27	68.7	84	810
	2013.12-2018.07	8AT	F	L	SUV 4WD N55B30A		2011100L	Drive Shaft		30	27	64.5	86.5	660
	2013.12-2018.07	8AT	F	R	SUV 4WD N55B30A		2051230L	Drive Shaft		30	27	64.5	86.5	973
	2013.12-2018.07	8AT	R	L/R	SUV 4WD N55B30A	Not for vehicles with electronic suspension control.For vehicles with towbar	2050700L	Drive Shaft		30	32	68.7	84	810
	2013.12-2018.07	8AT	R	L/R	SUV 4WD N55B30A	Not for vehicles with electronic suspension control.For vehicles without towbar	2050810L	Drive Shaft		30	27	68.7	84	810
	2013.12-2018.07	8AT	R	L/R	SUV 4WD N55B30A	for vehicles with electronic suspension control	2051490L	Drive Shaft		30			84.5	630





	 YEAR	TRANSM.	F/R	L/R	BODY STYLE & DRIVE TYPE & ENGINE	REMARKS	GSP Ref.	 PRODUCT	 ABS	Technical Specifications				
										A	B	C	H	L
BMW														
X5 xDrive 35i														
3.0 (235 kw)	2012.02-2013.06	8AT	F	L	SUV 4WD N55B30A		205052OL	Drive Shaft		30	27	64.5	86.5	636
	2012.02-2013.06	8AT	F	R	SUV 4WD N55B30A		205043OL	Drive Shaft		30	27	64.5	86.5	1023
	2012.02-2013.06	8AT	R	L/R	SUV 4WD N55B30A	for reinforced version	205070OL	Drive Shaft		30	32	68.7	84	810
	2012.02-2013.06	8AT	R	L/R	SUV 4WD N55B30A	not for reinforced version	205081OL	Drive Shaft		30	27	68.7	84	810
3.0 (240 kw)	2013.12-2018.07	8AT	F	L	SUV 4WD N55B30A		201110OL	Drive Shaft		30	27	64.5	86.5	660
	2013.12-2018.07	AT	F	R	SUV 4WD N55B30A		205123OL	Drive Shaft		30	27	64.5	86.5	973
	2013.12-2018.07	8AT	R	L/R	SUV 4WD N55B30A	For vehicles without electronic suspension control/For vehicles with towbar	205070OL	Drive Shaft		30	32	68.7	84	810
	2013.12-2018.07	8AT	R	L/R	SUV 4WD N55B30A	For vehicles without electronic suspension control/For vehicles without towbar	205081OL	Drive Shaft		30	27	68.7	84	810
	2013.12-2018.07	8AT	R	L/R	SUV 4WD N55B30A	For vehicles with Adaptive suspension	205149OL	Drive Shaft		30			84.5	630
X5 xDrive 40d														
3.0 (225 kw)	2010.04-2013.10	8AT	F	L	SUV 4WD N57D30B		201110OL	Drive Shaft		30	27	64.5	86.5	660
	2010.04-2013.10	8AT	F	R	SUV 4WD N57D30B		205123OL	Drive Shaft		30	27	64.5	86.5	973
	2010.04-2013.10	8AT	R	L/R	SUV 4WD N57D30B		205070OL	Drive Shaft		30	32	68.7	84	810
3.0 (230 kw)	2013.12-2018.07	8AT	F	L	SUV 4WD N57D30B		201110OL	Drive Shaft		30	27	64.5	86.5	660
	2013.12-2018.07	8AT	F	R	SUV 4WD N57D30B		205123OL	Drive Shaft		30	27	64.5	86.5	973
	2013.12-2018.07	8AT	R	L/R	SUV 4WD N57D30B	Not for vehicles with electronic suspension control/For vehicles with towbar	205070OL	Drive Shaft		30	32	68.7	84	810
	2013.12-2018.07	8AT	R	L/R	SUV 4WD N57D30B	For vehicles with electronic suspension control/For vehicles without towbar	205149OL	Drive Shaft		30			84.5	630
X5 xDrive 40e														
2.0 (155 kw)	2015.08-2018.07	8AT	F	L	SUV 4WD N20B20A		201110OL	Drive Shaft		30	27	64.5	86.5	660
	2015.08-2018.07	AT/8AT	F	R	SUV 4WD N20B20A		205123OL	Drive Shaft		30	27	64.5	86.5	973
	2015.08-2018.07	AT/8AT	R	L/R	SUV 4WD N20B20A		205081OL	Drive Shaft		30	27	68.7	84	810
2.0 (180 kw)	2015.08-2018.07	8AT	F	L	SUV 4WD N20B20A		201110OL	Drive Shaft		30	27	64.5	86.5	660
	2015.08-2018.07	AT/8AT	F	R	SUV 4WD N20B20A		205123OL	Drive Shaft		30	27	64.5	86.5	973
	2015.08-2018.07	AT/8AT	R	L/R	SUV 4WD N20B20A		205081OL	Drive Shaft		30	27	68.7	84	810
X5 xDrive 40i														
3.0 (225 kw)	2012.01-2013.12	AT	F	L	SUV 4WD N55B30A		205052OL	Drive Shaft		30	27	64.5	86.5	636
	2012.01-2013.12	AT	F	R	SUV 4WD N55B30A		205043OL	Drive Shaft		30	27	64.5	86.5	1023
	2012.01-2013.12	AT	R	L/R	SUV 4WD N55B30A	For vehicles with towbar	205070OL	Drive Shaft		30	32	68.7	84	810
	2012.01-2013.12	AT	R	L/R	SUV 4WD N55B30A	For vehicles without towbar	205081OL	Drive Shaft		30	27	68.7	84	810
X5 xDrive 48i														
4.8 (261 kw)	2008.10-2010.03	6AT	F	L	SUV 4WD N62B48B		205052OL	Drive Shaft		30	27	64.5	86.5	636
	2008.10-2010.03	6AT	F	R	SUV 4WD N62B48B		205043OL	Drive Shaft		30	27	64.5	86.5	1023
	2008.10-2010.03	6AT	R	L/R	SUV 4WD N62B48B	For reinforced version,Date To:2009.08,Date From:2009.09	205070OL	Drive Shaft		30	32	68.7	84	810
	2008.10-2010.03	6AT	R	L/R	SUV 4WD N62B48B	Not for reinforced version,Date To:2009.08	205081OL	Drive Shaft		30	27	68.7	84	810
X5 xDrive 50i														
4.4 (300 kw)	2010.04-2013.07	8AT	F	L	SUV 4WD N63B44A		205052OL	Drive Shaft		30	27	64.5	86.5	636
	2010.04-2013.07	8AT	F	R	SUV 4WD N63B44A		205043OL	Drive Shaft		30	27	64.5	86.5	1023
	2010.04-2013.07	8AT	R	L/R	SUV 4WD N63B44A		205070OL	Drive Shaft		30	32	68.7	84	810
4.4 (330 kw)	2013.08-2018.07	8AT	F	L	SUV 4WD N63B44B		205052OL	Drive Shaft		30	27	64.5	86.5	636
	2013.08-2018.07	8AT	F	R	SUV 4WD N63B44B		205043OL	Drive Shaft		30	27	64.5	86.5	1023
	2013.08-2018.07	8AT	R	L/R	SUV 4WD N63B44B	Total Length:630mm,For vehicles with electronic suspension control/	205149OL	Drive Shaft		30			84.5	630
	2013.08-2018.07	AT	R	L/R	SUV 4WD N63B44B	Total Length:809mm	205070OL	Drive Shaft		30	32	68.7	84	810
X5 xDrive M50d														
3.0 (280 kw)	2012.06-2013.10	8AT	F	L	SUV 4WD N57D30C		201110OL	Drive Shaft		30	27	64.5	86.5	660
	2012.06-2013.10	AT	F	R	SUV 4WD N57D30C		205123OL	Drive Shaft		30	27	64.5	86.5	973
	2013.12-2018.07	8AT	F	L	SUV 4WD N57D30C		201110OL	Drive Shaft		30	27	64.5	86.5	660
	2013.12-2018.07	8AT	F	R	SUV 4WD N57D30C		205123OL	Drive Shaft		30	27	64.5	86.5	973
X6 ActiveHybrid														
4.4 (300 kw)	2009.01-2014.06	AT/7AT	F	L	SUV 4WD N63B44A		205052OL	Drive Shaft		30	27	64.5	86.5	636
	2009.01-2014.06	AT/7AT	F	R	SUV 4WD N63B44A		205043OL	Drive Shaft		30	27	64.5	86.5	1023
	2009.01-2014.06	AT/7AT	R	L/R	SUV 4WD N63B44A		205070OL	Drive Shaft		30	32	68.7	84	810
X6 M														
4.4 (408 kw)	2009.07-2014.07	AT	F	L	SUV 4WD S63B44A		205052OL	Drive Shaft		30	27	64.5	86.5	636
	2009.07-2014.07	AT	F	R	SUV 4WD S63B44A		205043OL	Drive Shaft		30	27	64.5	86.5	1023
4.4 (423 kw)	2014.12-2019.07	AT	F	R	SUV 4WD S63B44B		205043OL	Drive Shaft		30	27	64.5	86.5	1023
X6 xDrive 28i														
2.0 (180 kw)	2015.06-2019.07	AT	R	L/R	SUV 4WD N20B20A	Date From:2016.01,With Enhanced Towing	205070OL	Drive Shaft		30	32	68.7	84	810
X6 xDrive 30d														
3.0 (155 kw)	2010.04-2014.07	8AT	F	R	SUV 4WD N57D30A		205123OL	Drive Shaft		30	27	64.5	86.5	973
	2010.04-2014.07	8AT	F	L/R	SUV 4WD N57D30A		201110OL	Drive Shaft		30	27	64.5	86.5	660
	2010.04-2014.07	8AT	R	L/R	SUV 4WD N57D30A	For vehicles with electronic suspension control/	205149OL	Drive Shaft		30			84.5	630
	2014.08-2019.07	8AT	F	L	SUV 4WD N57D30A		201110OL	Drive Shaft		30	27	64.5	86.5	660
	2014.08-2019.07	AT	F	R	SUV 4WD N57D30A		205123OL	Drive Shaft		30	27	64.5	86.5	973
	2014.08-2019.07	AT	R	L/R	SUV 4WD N57D30A	For vehicles without electronic suspension control/For vehicles with towbar	205070OL	Drive Shaft		30	32	68.7	84	810
	2014.08-2019.07	AT	R	L/R	SUV 4WD N57D30A	For vehicles without electronic suspension control/For vehicles without towbar	205081OL	Drive Shaft		30	27	68.7	84	810





		TRANSM.	F/R	L/R	BODY STYLE & DRIVE TYPE & ENGINE	REMARKS	GSP Ref.		ABS	Technical Specifications				
										A	B	C	H	L
BMW														
X6 xDrive 30d														
3.0 (155 kw)	2014.08-2019.07	AT	R	L/R	SUV 4WD N57D30A	For vehicles with Adaptive suspension	2051490L	Drive Shaft		30			84.5	630
3.0 (173 kw)	2008.04-2010.03	6AT	F	L	SUV 4WD M57D306D3		2050520L	Drive Shaft		30	27	64.5	86.5	636
	2008.04-2010.03	6AT	F	R	SUV 4WD M57D306D3		2050430L	Drive Shaft		30	27	64.5	86.5	1023
	2008.04-2010.03	6AT	R	L/R	SUV 4WD M57D306D3		2051490L	Drive Shaft		30			84.5	630
3.0 (180 kw)	2010.04-2014.06	8AT	F	R	SUV 4WD N57D30A		2051230L	Drive Shaft		30	27	64.5	86.5	973
	2010.04-2014.06	8AT	F	L/R	SUV 4WD N57D30A		2011100L	Drive Shaft		30	27	64.5	86.5	660
	2010.04-2014.06	8AT	R	L/R	SUV 4WD N57D30A	For vehicles with electronic suspension control	2051490L	Drive Shaft		30			84.5	630
3.0 (183 kw)	2014.12-2019.07	8AT	F	L	SUV 4WD N57D30A		2011100L	Drive Shaft		30	27	64.5	86.5	660
	2014.12-2019.07	AT	F	R	SUV 4WD N57D30A		2051230L	Drive Shaft		30	27	64.5	86.5	973
	2014.12-2019.07	8AT	R	L/R	SUV 4WD N57D30A	For vehicles without electronic suspension control	2050700L	Drive Shaft		30	32	68.7	84	810
	2014.12-2019.07	8AT	R	L/R	SUV 4WD N57D30A	For vehicles without electronic suspension control	2050810L	Drive Shaft		30	27	68.7	84	810
	2014.12-2019.07	8AT	R	L/R	SUV 4WD N57D30A	For vehicles with Adaptive suspension	2051490L	Drive Shaft		30			84.5	630
3.0 (190 kw)	2014.08-2019.07	8AT	F	L	SUV 4WD N57D30A		2011100L	Drive Shaft		30	27	64.5	86.5	660
	2014.08-2019.07	AT	F	R	SUV 4WD N57D30A		2051230L	Drive Shaft		30	27	64.5	86.5	973
	2014.08-2019.07	AT	R	L/R	SUV 4WD N57D30A	For vehicles without electronic suspension control	2050700L	Drive Shaft		30	32	68.7	84	810
	2014.08-2019.07	AT	R	L/R	SUV 4WD N57D30A	For vehicles without electronic suspension control	2050810L	Drive Shaft		30	27	68.7	84	810
	2014.08-2019.07	AT	R	L/R	SUV 4WD N57D30A	For vehicles with electronic suspension control	2051490L	Drive Shaft		30			84.5	630
3.0 (204 kw)	2014.08-2019.07	8AT	F	L	SUV 4WD N57D30A		2011100L	Drive Shaft		30	27	64.5	86.5	660
	2014.08-2019.07	AT	F	R	SUV 4WD N57D30A		2051230L	Drive Shaft		30	27	64.5	86.5	973
	2014.08-2019.07	AT	R	L/R	SUV 4WD N57D30A	For vehicles without electronic suspension control	2050700L	Drive Shaft		30	32	68.7	84	810
	2014.08-2019.07	AT	R	L/R	SUV 4WD N57D30A	For vehicles without electronic suspension control	2050810L	Drive Shaft		30	27	68.7	84	810
	2014.08-2019.07	AT	R	L/R	SUV 4WD N57D30A	For vehicles with Adaptive suspension	2051490L	Drive Shaft		30			84.5	630
X6 xDrive 35d														
3.0 (210 kw)	2008.01-2010.03	6AT	F	L	SUV 4WD M57D306D5		2050520L	Drive Shaft		30	27	64.5	86.5	636
	2008.01-2010.03	6AT	F	R	SUV 4WD M57D306D5		2050430L	Drive Shaft		30	27	64.5	86.5	1023
	2008.01-2010.03	6AT	R	L/R	SUV 4WD M57D306D5		2051490L	Drive Shaft		30			84.5	630
X6 xDrive 35i														
3.0 (224 kw)	2008.01-2014.06	AT	F	L	SUV 4WD N54B30A/N55B30A		2050520L	Drive Shaft		30	27	64.5	86.5	636
	2008.01-2014.06	AT	F	R	SUV 4WD N54B30A/N55B30A		2050430L	Drive Shaft		30	27	64.5	86.5	1023
3.0 (225 kw)	2008.01-2014.07	AT	F	L	SUV 4WD N54B30A/N55B30A		2050520L	Drive Shaft		30	27	64.5	86.5	636
	2008.01-2014.07	AT	F	R	SUV 4WD N54B30A/N55B30A		2050430L	Drive Shaft		30	27	64.5	86.5	1023
	2008.01-2014.07	AT	R	L/R	SUV 4WD N54B30A/N55B30A		2051490L	Drive Shaft		30			84.5	630
	2014.08-2019.07	8AT	F	L	SUV 4WD N55B30A		2011100L	Drive Shaft		30	27	64.5	86.5	660
	2014.08-2019.07	AT	F	R	SUV 4WD N55B30A		2051230L	Drive Shaft		30	27	64.5	86.5	973
	2014.08-2019.07	AT	R	L/R	SUV 4WD N55B30A	For vehicles without electronic suspension control	2050700L	Drive Shaft		30	32	68.7	84	810
	2014.08-2019.07	AT	R	L/R	SUV 4WD N55B30A	For vehicles without electronic suspension control	2050810L	Drive Shaft		30	27	68.7	84	810
3.0 (235 kw)	2014.08-2019.07	AT	R	L/R	SUV 4WD N55B30A	For vehicles with Adaptive suspension	2051490L	Drive Shaft		30			84.5	630
	2012.01-2014.06	8AT	F	L	SUV 4WD N55B30A		2050520L	Drive Shaft		30	27	64.5	86.5	636
	2012.01-2014.06	8AT	F	R	SUV 4WD N55B30A		2050430L	Drive Shaft		30	27	64.5	86.5	1023
3.0 (240 kw)	2012.01-2014.06	8AT	R	L/R	SUV 4WD N55B30A		2051490L	Drive Shaft		30			84.5	630
	2009.08-2010.03	AT	F	L	SUV 4WD N54B30A		2050520L	Drive Shaft		30	27	64.5	86.5	636
	2009.08-2010.03	AT	F	R	SUV 4WD N54B30A		2050430L	Drive Shaft		30	27	64.5	86.5	1023
	2009.08-2010.03	AT	R	L/R	SUV 4WD N54B30A		2051490L	Drive Shaft		30			84.5	630
	2014.08-2019.07	8AT	F	L	SUV 4WD N55B30A		2011100L	Drive Shaft		30	27	64.5	86.5	660
	2014.08-2019.07	AT	F	R	SUV 4WD N55B30A		2051230L	Drive Shaft		30	27	64.5	86.5	973
	2014.08-2019.07	AT	R	L/R	SUV 4WD N55B30A	For vehicles without electronic suspension control	2050700L	Drive Shaft		30	32	68.7	84	810
	2014.08-2019.07	AT	R	L/R	SUV 4WD N55B30A	For vehicles without electronic suspension control	2050810L	Drive Shaft		30	27	68.7	84	810
2014.08-2019.07	AT	R	L/R	SUV 4WD N55B30A	For vehicles with Adaptive suspension	2051490L	Drive Shaft		30			84.5	630	
X6 xDrive 40d														
3.0 (225 kw)	2010.04-2014.06	8AT	F	L	SUV 4WD N57D30B		2011100L	Drive Shaft		30	27	64.5	86.5	660
	2010.04-2014.06	8AT	F	R	SUV 4WD N57D30B		2051230L	Drive Shaft		30	27	64.5	86.5	973
	2010.04-2014.06	8AT	R	L/R	SUV 4WD N57D30B		2051490L	Drive Shaft		30			84.5	630
3.0 (230 kw)	2014.12-2019.07	8AT	F	L	SUV 4WD N57D30B		2011100L	Drive Shaft		30	27	64.5	86.5	660
	2014.12-2019.07	AT	F	R	SUV 4WD N57D30B		2051230L	Drive Shaft		30	27	64.5	86.5	973
	2014.12-2019.07	8AT	R	L/R	SUV 4WD N57D30B	for SA code:S2VPA	2051490L	Drive Shaft		30			84.5	630
	2014.12-2019.07	AT	R	L/R	SUV 4WD N57D30B	For vehicles without electronic suspension control	2050700L	Drive Shaft		30	32	68.7	84	810
X6 xDrive 40i														
3.0 (235 kw)	2012.08-2014.06	8AT	F	L	SUV 4WD N55B30A		2050520L	Drive Shaft		30	27	64.5	86.5	636
	2012.08-2014.06	8AT	F	R	SUV 4WD N55B30A		2050430L	Drive Shaft		30	27	64.5	86.5	1023
	2012.08-2014.06	8AT	R	L/R	SUV 4WD N55B30A		2051490L	Drive Shaft		30			84.5	630
X6 xDrive 50i														
4.4 (300 kw)	2008.07-2014.07	AT	F	L	SUV 4WD N63B44A		2050520L	Drive Shaft		30	27	64.5	86.5	636
	2008.07-2014.07	AT	F	R	SUV 4WD N63B44A		2050430L	Drive Shaft		30	27	64.5	86.5	1023
	2008.07-2014.07	AT	R	L/R	SUV 4WD N63B44A		2051490L	Drive Shaft		30			84.5	630
4.4 (330 kw)	2009.08-2014.06	AT	F	L	SUV 4WD N63B44A		2050520L	Drive Shaft		30	27	64.5	86.5	636



 YEAR	TRANS.	F/R	L/R	BODY STYLE & DRIVE TYPE & ENGINE	REMARKS	GSP Ref.	 PRODUCT	ABS	Technical Specifications					
									A	B	C	H	L	
BMW														
X6 xDrive 50i														
4.4 (330 kw)	2009.08-2014.06	AT	F	R	SUV 4WD N63B44A		2050430L	Drive Shaft		30	27	64.5	86.5	1023
	2009.08-2014.06	AT	R	L/R	SUV 4WD N63B44A		2051490L	Drive Shaft		30			84.5	630
	2014.08-2019.07	AT	F	L	SUV 4WD N63B44B		2050520L	Drive Shaft		30	27	64.5	86.5	636
	2014.08-2019.07	AT	F	R	SUV 4WD N63B44B		2050430L	Drive Shaft		30	27	64.5	86.5	1023
	2014.08-2019.07	AT	R	L/R	SUV 4WD N63B44B	For vehicles without electronic suspension control	2050700L	Drive Shaft		30	32	68.7	84	810
	2014.08-2019.07	AT	R	L/R	SUV 4WD N63B44B	For vehicles with electronic suspension control	2051490L	Drive Shaft		30			84.5	630
X6 xDrive M50d														
3.0 (280 kw)	2012.04-2014.06	8AT	F	L	SUV 4WD N57D30C		2011100L	Drive Shaft		30	27	64.5	86.5	660
	2012.04-2014.06	8AT	F	R	SUV 4WD N57D30C		2051230L	Drive Shaft		30	27	64.5	86.5	973
	2014.08-2019.07	8AT	F	L	SUV 4WD N57D30C		2011100L	Drive Shaft		30	27	64.5	86.5	660
	2014.08-2019.07	AT	F	R	SUV 4WD N57D30C		2051230L	Drive Shaft		30	27	64.5	86.5	973
CUPRA														
Born														
ET (110 kw)	2021.08-	ET	R	L	Hatchback RWD EBJC	For PR code:5LC	2040930L	Drive Shaft		36	37	59.5	34	611
	2021.08-	ET	R	R	Hatchback RWD EBJC	For PR code:5LC	2040920L	Drive Shaft		36	37	59.5	34	840
ET (150 kw)	2021.08-	ET	R	L	Hatchback RWD EBJC	For PR code:5LC	2040930L	Drive Shaft		36	37	59.5	34	611
	2021.08-	ET	R	R	Hatchback RWD EBJC	For PR code:5LC	2040920L	Drive Shaft		36	37	59.5	34	840
Formentor														
2.0 (180 kw)	2021.03-	7AT	F	L	SUV FWD DNPA		2023510L	Drive Shaft		36	37	59.5	40	570
FIAT														
Fullback														
2.4 (110 kw)	2016.04-	AT/MT	F	L	Pick up 4WD 4N15		2391630L	Drive Shaft	47T	30	28	69	98	594
	2016.04-	AT/MT	F	R	Pick up 4WD 4N15		2391640L	Drive Shaft	47T	30		69	98	489
2.4 (113 kw)	2016.04-	AT/MT	F	L	Pick up 4WD 4N15		2391630L	Drive Shaft	47T	30	28	69	98	594
	2016.04-	AT/MT	F	R	Pick up 4WD 4N15		2391640L	Drive Shaft	47T	30		69	98	489
2.4 (133 kw)	2016.04-	AT/MT	F	L	Pick up 4WD 4N15		2391630L	Drive Shaft	47T	30	28	69	98	594
	2016.04-	AT/MT	F	R	Pick up 4WD 4N15		2391640L	Drive Shaft	47T	30		69	98	489
Talento														
1.6 (70 kw)	2016.06-	6MT	F	L	Bus FWD R9M413		2025480L	Drive Shaft		29	39	60	95.5	694
	2016.06-	6MT	F	R	Bus FWD R9M413		2184450L	Drive Shaft		29	39	60	95.5	1020
	2016.06-	6MT	F	L	Van FWD R9M413		2025480L	Drive Shaft		29	39	60	95.5	694
	2016.06-	6MT	F	R	Van FWD R9M413		2184450L	Drive Shaft		29	39	60	95.5	1020
1.6 (85 kw)	2016.06-	6MT	F	L	Van FWD R9M408		2025480L	Drive Shaft		29	39	60	95.5	694
	2016.06-	6MT	F	R	Van FWD R9M408		2184450L	Drive Shaft		29	39	60	95.5	1020
1.6 (89 kw)	2016.06-	6MT	F	L	Platform/Chassis FWD R9M413		2025480L	Drive Shaft		29	39	60	95.5	694
	2016.06-	6MT	F	R	Platform/Chassis FWD R9M413		2184450L	Drive Shaft		29	39	60	95.5	1020
	2016.06-	6MT	F	L	Van FWD R9M413		2025480L	Drive Shaft		29	39	60	95.5	694
	2016.06-	6MT	F	R	Van FWD R9M413		2184450L	Drive Shaft		29	39	60	95.5	1020
1.6 (92 kw)	2016.06-	6MT	F	L	Bus FWD R9M452		2025480L	Drive Shaft		29	39	60	95.5	694
	2016.06-	6MT	F	R	Bus FWD R9M452		2184450L	Drive Shaft		29	39	60	95.5	1020
	2016.06-	6MT	F	L	Platform/Chassis FWD R9M452		2025480L	Drive Shaft		29	39	60	95.5	694
	2016.06-	6MT	F	R	Platform/Chassis FWD R9M452		2184450L	Drive Shaft		29	39	60	95.5	1020
	2016.06-	6MT	F	L	Van FWD R9M452		2025480L	Drive Shaft		29	39	60	95.5	694
	2016.06-	6MT	F	R	Van FWD R9M452		2184450L	Drive Shaft		29	39	60	95.5	1020
1.6 (107 kw)	2016.06-	6MT	F	L	Bus FWD R9M452		2025480L	Drive Shaft		29	39	60	95.5	694
	2016.06-	6MT	F	R	Bus FWD R9M452		2184450L	Drive Shaft		29	39	60	95.5	1020
	2016.06-	6MT	F	L	Platform/Chassis FWD R9M452		2025480L	Drive Shaft		29	39	60	95.5	694
	2016.06-	6MT	F	R	Platform/Chassis FWD R9M452		2184450L	Drive Shaft		29	39	60	95.5	1020
	2016.06-	6MT	F	L	Van FWD R9M452		2025480L	Drive Shaft		29	39	60	95.5	694
	2016.06-	6MT	F	R	Van FWD R9M452		2184450L	Drive Shaft		29	39	60	95.5	1020
2.0 (88 kw)	2019.07-	6MT	F	L	Bus FWD M9R710		2025480L	Drive Shaft		29	39	60	95.5	694
	2019.07-	6MT	F	R	Van FWD M9R710		2025480L	Drive Shaft		29	39	60	95.5	694
2.0 (107 kw)	2019.07-	6MT	F	L	Bus FWD M9R710		2025480L	Drive Shaft		29	39	60	95.5	694
	2019.07-	6MT	F	R	Platform/Chassis FWD M9R710		2025480L	Drive Shaft		29	39	60	95.5	694
	2019.07-	6MT	F	L	Van FWD M9R710		2025480L	Drive Shaft		29	39	60	95.5	694
2.0 (125 kw)	2019.07-	6MT	F	L	Platform/Chassis FWD M9R710		2025480L	Drive Shaft		29	39	60	95.5	694
	2019.07-	6MT	F	R	Van FWD M9R710		2025480L	Drive Shaft		29	39	60	95.5	694
FORD														
Focus														
1.5 (88 kw)	2018.01-	8AT	F	L	Hatchback FWD ZTDA/ZTDB		2028550L	Drive Shaft		27	35	55.9	96.5	686
	2018.01-	8AT	F	R	Hatchback FWD ZTDA/ZTDB		2028560L	Drive Shaft		27	35	55.9	96.5	943
	2018.11-	8AT	F	L	Saloon FWD ZTDA/ZTDB		2028550L	Drive Shaft		27	35	55.9	96.5	686
	2018.11-	8AT	F	R	Saloon FWD ZTDA/ZTDB		2028560L	Drive Shaft		27	35	55.9	96.5	943





	 YEAR	TRANSM.	F/R	L/R	BODY STYLE & DRIVE TYPE & ENGINE	REMARKS	GSP Ref.	 PRODUCT	 ABS	Technical Specifications				
										A	B	C	H	L
FORD														
Focus Estate/Wagon														
1.5 (88 kw)	2018.09-	8AT	F	L	Estate FWD ZTDA/ZTDB		2028550L	Drive Shaft		27	35	55.9	96.5	686
	2018.09-	8AT	F	R	Estate FWD ZTDA/ZTDB		2028560L	Drive Shaft		27	35	55.9	96.5	943
Galaxy														
1.6 (85 kw)	2011.02-2015.06	6MT	F	L	MPV FWD T1WA/T1WB		2992110L	Drive Shaft		40	26	57.4	51	603
1.8 (74 kw)	2006.04-2015.06	5MT	F	L	MPV FWD FFVA		2992110L	Drive Shaft		40	26	57.4	51	603
1.8 (92 kw)	2006.06-2015.06	5MT	F	L	MPV FWD QYWA		2992110L	Drive Shaft		40	26	57.4	51	603
2.0 (85 kw)	2007.11-2015.06	6MT	F	L	MPV FWD KLWA/TYWA		2992110L	Drive Shaft		40	26	57.4	51	603
2.0 (96 kw)	2006.04-2015.06	6MT	F	L	MPV FWD AZWA		2992110L	Drive Shaft		40	26	57.4	51	603
2.0 (100 kw)	2006.04-2015.06	6MT	F	L	MPV FWD AZWC/UKWA		2992110L	Drive Shaft		40	26	57.4	51	603
2.0 (103 kw)	2006.04-2015.06	6MT	F	L	MPV FWD QXWA/QXWB/QXWC/UFWA		2992110L	Drive Shaft		40	26	57.4	51	603
2.0 (107 kw)	2006.05-2015.06	5MT	F	L	MPV FWD AOWA/AOWB/TBWA/TBWB		2992110L	Drive Shaft		40	26	57.4	51	603
	2006.05-2015.06	5MT	F	L	MPV FWD TBWA/TBWB		2992110L	Drive Shaft		40	26	57.4	51	603
2.0 (120 kw)	2010.03-2015.06	6MT	F	L	MPV FWD TXWA		2992110L	Drive Shaft		40	26	57.4	51	603
Galaxy Van														
1.6 (85 kw)	2013.03-2015.06	6MT	F	L	MPV Van FWD T1WA/T1WB		2992110L	Drive Shaft		40	26	57.4	51	603
2.0 (96 kw)	2006.11-2015.06	6MT	F	L	MPV Van FWD AZWA		2992110L	Drive Shaft		40	26	57.4	51	603
2.0 (103 kw)	2006.04-2015.06	6MT	F	L	MPV Van FWD QXWA/QXWB/QXWC/UFWA		2992110L	Drive Shaft		40	26	57.4	51	603
2.0 (107 kw)	2006.05-2015.06	5MT	F	L	MPV Van FWD AOWA		2992110L	Drive Shaft		40	26	57.4	51	603
2.0 (120 kw)	2010.03-2015.06	6MT	F	L	MPV Van FWD TXWA		2992110L	Drive Shaft		40	26	57.4	51	603
Mondeo														
1.6 (85 kw)	2010.12-2014.09	6MT	F	L	Saloon FWD T1BA/T1BB/T1BC		2992110L	Drive Shaft		40	26	57.4	51	603
	2011.02-2014.09	6MT	F	L	Hatchback FWD T1BA/T1BB/T1BC		2992110L	Drive Shaft		40	26	57.4	51	603
1.8 (74 kw)	2007.06-2014.09	6MT	F	L	Hatchback FWD FFBA		2992110L	Drive Shaft		40	26	57.4	51	603
	2007.09-2014.09	6MT	F	L	Saloon FWD FFBA		2992110L	Drive Shaft		40	26	57.4	51	603
1.8 (92 kw)	2007.03-2014.09	6MT	F	L	Hatchback FWD KHBA/QYBA		2992110L	Drive Shaft		40	26	57.4	51	603
	2007.03-2014.09	6MT	F	L	Saloon FWD KHBA/QYBA		2992110L	Drive Shaft		40	26	57.4	51	603
2.0 (85 kw)	2007.11-2014.09	6MT	F	L	Hatchback FWD KLBA/LPBA/TYBA		2992110L	Drive Shaft		40	26	57.4	51	603
	2007.11-2014.09	6MT	F	L	Saloon FWD KLBA/LPBA/TYBA		2992110L	Drive Shaft		40	26	57.4	51	603
2.0 (96 kw)	2007.03-2014.09	6MT	F	L	Hatchback FWD AZBA		2992110L	Drive Shaft		40	26	57.4	51	603
	2007.03-2014.09	6MT	F	L	Saloon FWD AZBA		2992110L	Drive Shaft		40	26	57.4	51	603
2.0 (100 kw)	2007.03-2014.12	6MT	F	L	Hatchback FWD AZBC/UKBA/UKBB		2992110L	Drive Shaft		40	26	57.4	51	603
	2008.01-2014.12	6MT	F	L	Saloon FWD AZBC/UKBA/UKBB		2992110L	Drive Shaft		40	26	57.4	51	603
2.0 (103 kw)	2007.03-2014.09	6MT	F	L	Hatchback FWD QXBA/QXBB/UFBA/UFBB		2992110L	Drive Shaft		40	26	57.4	51	603
	2007.03-2014.09	6MT	F	L	Saloon FWD QXBA/QXBB/UFBA/UFBB		2992110L	Drive Shaft		40	26	57.4	51	603
2.0 (107 kw)	2007.03-2014.09	5MT	F	L	Hatchback FWD AOWA/AOBC/TBBA/TBBB		2992110L	Drive Shaft		40	26	57.4	51	603
	2007.03-2014.09	5MT	F	L	Saloon FWD AOWA/AOBC/TBBA/TBBB		2992110L	Drive Shaft		40	26	57.4	51	603
	2008.12-2014.09	5MT	F	L	Hatchback FWD TBBA/TBBB		2992110L	Drive Shaft		40	26	57.4	51	603
	2008.12-2014.09	5MT	F	L	Saloon FWD TBBA/TBBB		2992110L	Drive Shaft		40	26	57.4	51	603
	2009.07-2014.09	5MT	F	L	Hatchback FWD TBBA/TBBB		2992110L	Drive Shaft		40	26	57.4	51	603
	2009.07-2014.09	5MT	F	L	Saloon FWD TBBA/TBBB		2992110L	Drive Shaft		40	26	57.4	51	603
2.0 (120 kw)	2010.03-2014.09	6MT	F	L	Hatchback FWD TXBA/TXBB		2992110L	Drive Shaft		40	26	57.4	51	603
	2010.03-2014.09	6MT	F	L	Saloon FWD TXBA/TXBB		2992110L	Drive Shaft		40	26	57.4	51	603
2.5 (162 kw)	2007.03-2014.09	6MT	F	L	Hatchback FWD HUBA		2210700L	Drive Shaft		40	26	57.4	52	556
	2007.03-2014.09	6MT	F	L	Saloon FWD HUBA		2210700L	Drive Shaft		40	26	57.4	52	556
Mondeo Estate/Wagon														
1.6 (85 kw)	2011.02-2014.09	6MT	F	L	Estate FWD T1BA/T1BB/T1BC		2992110L	Drive Shaft		40	26	57.4	51	603
	2013.03-2014.09	6MT	F	L	Combi Van FWD T1BA/T1BB/T1BC		2992110L	Drive Shaft		40	26	57.4	51	603
1.8 (74 kw)	2007.06-2012.12	6MT	F	L	Estate FWD FFBA		2992110L	Drive Shaft		40	26	57.4	51	603
1.8 (92 kw)	2007.06-2012.12	6MT	F	L	Estate FWD KHBA/QYBA		2992110L	Drive Shaft		40	26	57.4	51	603
2.0 (85 kw)	2007.11-2014.09	6MT	F	L	Combi Van FWD KLBA		2992110L	Drive Shaft		40	26	57.4	51	603
	2007.11-2014.09	6MT	F	L	Estate FWD KLBA/LPBA/TYBA		2992110L	Drive Shaft		40	26	57.4	51	603
2.0 (96 kw)	2007.03-2012.12	6MT	F	L	Estate FWD AZBA		2992110L	Drive Shaft		40	26	57.4	51	603
2.0 (100 kw)	2007.03-2014.12	6MT	F	L	Estate FWD AZBC/UKBA/UKBB		2992110L	Drive Shaft		40	26	57.4	51	603
2.0 (103 kw)	2007.03-2014.09	6MT	F	L	Combi Van FWD QXBB/UFBA/UFBB		2992110L	Drive Shaft		40	26	57.4	51	603
	2007.03-2014.09	6MT	F	L	Estate FWD QXBA/QXBB/UFBA/UFBB		2992110L	Drive Shaft		40	26	57.4	51	603
2.0 (107 kw)	2007.03-2014.09	5MT	F	L	Combi Van FWD AOBC		2992110L	Drive Shaft		40	26	57.4	51	603
	2007.03-2014.09	5MT	F	L	Estate FWD AOWA/AOBC/TBBA/TBBB		2992110L	Drive Shaft		40	26	57.4	51	603
	2008.12-2014.09	5MT	F	L	Estate FWD TBBA/TBBB		2992110L	Drive Shaft		40	26	57.4	51	603
	2009.07-2014.09	5MT	F	L	Estate FWD TBBA/TBBB		2992110L	Drive Shaft		40	26	57.4	51	603
2.0 (120 kw)	2010.03-2014.09	6MT	F	L	Combi Van FWD TXBA		2992110L	Drive Shaft		40	26	57.4	51	603
	2010.03-2014.09	6MT	F	L	Estate FWD TXBA/TXBB		2992110L	Drive Shaft		40	26	57.4	51	603
2.5 (162 kw)	2007.03-2012.12	6MT	F	L	Estate FWD HUBA		2210700L	Drive Shaft		40	26	57.4	52	556
S-Max														
1.6 (85 kw)	2011.02-2014.12	6MT	F	L	MPV FWD T1WA/T1WB		2992110L	Drive Shaft		40	26	57.4	51	603
1.8 (74 kw)	2007.01-2010.12	5MT	F	L	MPV FWD FFVA		2992110L	Drive Shaft		40	26	57.4	51	603



	 YEAR	TRANSM.	F/R	L/R	BODY STYLE & DRIVE TYPE & ENGINE	REMARKS	GSP Ref.	 PRODUCT	 ABS	Technical Specifications					
										A	B	C	H	L	
FORD S-Max															
1.8 (92 kw)	2006.06-2014.12	5MT	F	L	MPV FWD QYWA		2992110L	Drive Shaft		40	26	57.4	51	603	
2.0 (85 kw)	2007.01-2014.12	6MT	F	L	MPV FWD KLWA/TYWA		2992110L	Drive Shaft		40	26	57.4	51	603	
	2007.01-2014.12	6MT	F	L	MPV Van FWD KLWA/TYWA		2992110L	Drive Shaft		40	26	57.4	51	603	
2.0 (96 kw)	2006.03-2014.12	6MT	F	L	MPV FWD AZWA		2992110L	Drive Shaft		40	26	57.4	51	603	
2.0 (100 kw)	2008.03-2014.12	6MT	F	L	MPV FWD AZWC/UKWA		2992110L	Drive Shaft		40	26	57.4	51	603	
2.0 (103 kw)	2006.05-2014.12	6MT	F	L	MPV FWD QXWA/QXWB/QXWC/UFWA		2992110L	Drive Shaft		40	26	57.4	51	603	
	2010.03-2014.12	6MT	F	L	MPV Van FWD QXWA/QXWB/QXWC/UFWA		2992110L	Drive Shaft		40	26	57.4	51	603	
2.0 (107 kw)	2006.03-2014.12	5MT	F	L	MPV FWD AODA/AODB/AODE/AOWA/AOWB		2992110L	Drive Shaft		40	26	57.4	51	603	
	2006.05-2014.12	5MT	F	L	MPV FWD TBWA/TBWB		2992110L	Drive Shaft		40	26	57.4	51	603	
	2010.03-2014.12	5MT	F	L	MPV Van FWD AODE		2992110L	Drive Shaft		40	26	57.4	51	603	
2.0 (120 kw)	2010.03-2014.12	6MT	F	L	MPV FWD TXWA		2992110L	Drive Shaft		40	26	57.4	51	603	
	2010.03-2014.12	6MT	F	L	MPV Van FWD TXWA		2992110L	Drive Shaft		40	26	57.4	51	603	
2.5 (162 kw)	2006.03-2014.12	6MT	F	L	MPV FWD HUWA		2210700L	Drive Shaft		40	26	57.4	52	556	
Tourneo Custom															
2.0 (77 kw)	2015.12-	6MT	F	L	Bus FWD BJFA/BJFB/YLF6/YLFA/YLFB/YLFS		2183340L	Drive Shaft		31	41	58	121	752	
	2015.12-	6MT	F	R	Bus FWD BJFA/BJFB/YLF6/YLFA/YLFB/YLFS		2183350L	Drive Shaft		31	41	58	121	1092	
2.0 (96 kw)	2015.12-	6MT	F	L	Bus FWD BKFA/BKFB/YMF6/YMFA/YMFB/YMFS		2183340L	Drive Shaft		31	41	58	121	752	
	2015.12-	6MT	F	R	Bus FWD BKFA/BKFB/YMF6/YMFA/YMFB/YMFS		2183350L	Drive Shaft		31	41	58	121	1092	
	2019.05-	6MT	F	L	Bus FWD BKFC/BKFD		2183340L	Drive Shaft		31	41	58	121	752	
	2019.05-	6MT	F	R	Bus FWD BKFC/BKFD		2183350L	Drive Shaft		31	41	58	121	1092	
2.0 (125 kw)	2015.12-	6MT	F	L	Bus FWD BLFA/BLFB/YNF6/YNFA/YNFB/YNFS		2183340L	Drive Shaft		31	41	58	121	752	
	2015.12-	6MT	F	R	Bus FWD BLFA/BLFB/YNF6/YNFA/YNFB/YNFS		2183350L	Drive Shaft		31	41	58	121	1092	
2.0 (136 kw)	2019.05-	6MT	F	L	Bus FWD BCFA/BCFB	Trim Level:2	2183340L	Drive Shaft		31	41	58	121	752	
	2019.05-	6MT	F	R	Bus FWD BCFA/BCFB	Trim Level:2	2183350L	Drive Shaft		31	41	58	121	1092	
	2019.05-	6MT	F	L	Bus FWD BCFC/BCFD		2183340L	Drive Shaft		31	41	58	121	752	
	2019.05-	6MT	F	R	Bus FWD BCFC/BCFD		2183350L	Drive Shaft		31	41	58	121	1092	
2.2 (74 kw)	2012.09-2015.12	6MT	F	L	Bus FWD DRF4/DRFF/DRFG		2183340L	Drive Shaft		31	41	58	121	752	
	2012.09-2015.12	6MT	F	R	Bus FWD DRF4/DRFF/DRFG		2183350L	Drive Shaft		31	41	58	121	1092	
2.2 (92 kw)	2012.09-2015.12	6MT	F	L	Bus FWD CYF4/CYFF		2183340L	Drive Shaft		31	41	58	121	752	
	2012.09-2015.12	6MT	F	R	Bus FWD CYF4/CYFF		2183350L	Drive Shaft		31	41	58	121	1092	
2.2 (114 kw)	2012.09-2015.12	6MT	F	L	Bus FWD CVFF		2183340L	Drive Shaft		31	41	58	121	752	
	2012.09-2015.12	6MT	F	R	Bus FWD CVFF		2183350L	Drive Shaft		31	41	58	121	1092	
Transit 290															
2.0 (77 kw)	2016.03-	6MT	F	L	Van FWD BJFA/BJFB/YLF6/YLFA/YLFB/YLFS		2183340L	Drive Shaft		31	41	58	121	752	
	2016.03-	6MT	F	R	Van FWD BJFA/BJFB/YLF6/YLFA/YLFB/YLFS		2183350L	Drive Shaft		31	41	58	121	1092	
2.0 (96 kw)	2016.03-	6MT	F	L	Van FWD BKFA/BKFB/YMF6/YMFA/YMFB/YMFS		2183340L	Drive Shaft		31	41	58	121	752	
	2016.03-	6MT	F	R	Van FWD BKFA/BKFB/YMF6/YMFA/YMFB/YMFS		2183350L	Drive Shaft		31	41	58	121	1092	
	2019.05-	6MT	F	L	Van FWD BKFC/BKFD		2183340L	Drive Shaft		31	41	58	121	752	
	2019.05-	6MT	F	R	Van FWD BKFC/BKFD		2183350L	Drive Shaft		31	41	58	121	1092	
2.2 (74 kw)	2013.08-2018.12	6MT	F	L	Van FWD DRF5/DRFF/DRFG		2183340L	Drive Shaft		31	41	58	121	752	
	2013.08-2018.12	6MT	F	R	Van FWD DRF5/DRFF/DRFG		2183350L	Drive Shaft		31	41	58	121	1092	
2.2 (92 kw)	2013.08-2018.12	6MT	F	L	Van FWD CY14/CYF5/CYFG/USF6		2183340L	Drive Shaft		31	41	58	121	752	
	2013.08-2018.12	6MT	F	R	Van FWD CY14/CYF5/CYFG/USF6		2183350L	Drive Shaft		31	41	58	121	1092	
2.2 (114 kw)	2013.08-2018.12	6MT	F	L	Van FWD CVF5		2183340L	Drive Shaft		31	41	58	121	752	
	2013.08-2018.12	6MT	F	R	Van FWD CVF5		2183350L	Drive Shaft		31	41	58	121	1092	
Transit 310															
2.0 (77 kw)	2016.03-	6MT	F	L	Bus FWD BJFA/BJFB/YLF6/YLFA/YLFB/YLFS		2183340L	Drive Shaft		31	41	58	121	752	
	2016.03-	6MT	F	R	Bus FWD BJFA/BJFB/YLF6/YLFA/YLFB/YLFS		2183350L	Drive Shaft		31	41	58	121	1092	
	2016.03-	6MT	F	L	Platform/Chassis FWD BJFA/BJFB/YLF6/YLFA/YLFB/YLFS		2183340L	Drive Shaft		31	41	58	121	752	
	2016.03-	6MT	F	R	Platform/Chassis FWD BJFA/BJFB/YLF6/YLFA/YLFB/YLFS		2183350L	Drive Shaft		31	41	58	121	1092	
	2016.03-	6MT	F	L	Van FWD BJFA/BJFB/YLF6/YLFA/YLFB/YLFS		2183340L	Drive Shaft		31	41	58	121	752	
	2016.03-	6MT	F	R	Van FWD BJFA/BJFB/YLF6/YLFA/YLFB/YLFS		2183350L	Drive Shaft		31	41	58	121	1092	
2.0 (96 kw)	2016.03-	6MT	F	L	Bus FWD BKFA/BKFB/YMF6/YMFA/YMFB/YMFS		2183340L	Drive Shaft		31	41	58	121	752	
	2016.03-	6MT	F	R	Bus FWD BKFA/BKFB/YMF6/YMFA/YMFB/YMFS		2183350L	Drive Shaft		31	41	58	121	1092	
	2016.03-	6MT	F	L	Platform/Chassis FWD BKFA/BKFB/YMF6/YMFA/YMFB/YMFS		2183340L	Drive Shaft		31	41	58	121	752	
	2016.03-	6MT	F	R	Platform/Chassis FWD BKFA/BKFB/YMF6/YMFA/YMFB/YMFS		2183350L	Drive Shaft		31	41	58	121	1092	
	2016.03-	6MT	F	L	Van FWD BKFA/BKFB/YMF6/YMFA/YMFB/YMFS		2183340L	Drive Shaft		31	41	58	121	752	
	2016.03-	6MT	F	R	Van FWD BKFA/BKFB/YMF6/YMFA/YMFB/YMFS		2183350L	Drive Shaft		31	41	58	121	1092	
	2019.05-	6MT	F	L	Bus FWD BKFC/BKFD		2183340L	Drive Shaft		31	41	58	121	752	
	2019.05-	6MT	F	R	Bus FWD BKFC/BKFD		2183350L	Drive Shaft		31	41	58	121	1092	
	2019.05-	6MT	F	L	Platform/Chassis FWD BKFC/BKFD		2183340L	Drive Shaft		31	41	58	121	752	
	2019.05-	6MT	F	R	Platform/Chassis FWD BKFC/BKFD		2183350L	Drive Shaft		31	41	58	121	1092	
	2019.05-	6MT	F	L	Van FWD BKFC/BKFD		2183340L	Drive Shaft		31	41	58	121	752	
	2019.05-	6MT	F	R	Van FWD BKFC/BKFD		2183350L	Drive Shaft		31	41	58	121	1092	
	2.0 (125 kw)	2016.03-	6MT	F	L	Bus FWD YNF6/YNFS		2183340L	Drive Shaft		31	41	58	121	752



  YEAR	TRANSM.	F/R	L/R	BODY STYLE & DRIVE TYPE & ENGINE	REMARKS	GSP Ref.	 PRODUCT	 ABS	Technical Specifications				
									A	B	C	H	L
FORD													
Transit 310													
2.0 (125 kw)	2016.03-	6MT	F	R	Bus FWD YNF6/YNFS	2183350L	Drive Shaft		31	41	58	121	1092
	2016.03-	6MT	F	L	Van FWD BLFA/BLFB/YNF6/YNFA/YNFB/YNFS	2183340L	Drive Shaft		31	41	58	121	752
	2016.03-	6MT	F	R	Van FWD BLFA/BLFB/YNF6/YNFA/YNFB/YNFS	2183350L	Drive Shaft		31	41	58	121	1092
	2018.12-	6MT	F	L	Platform/Chassis FWD BLFA/BLFB/YNFA/YNFB	2183340L	Drive Shaft		31	41	58	121	752
	2018.12-	6MT	F	R	Platform/Chassis FWD BLFA/BLFB/YNFA/YNFB	2183350L	Drive Shaft		31	41	58	121	1092
	2019.05-	6MT	F	L	Van FWD BLFC/BLFD	2183340L	Drive Shaft		31	41	58	121	752
	2019.05-	6MT	F	R	Van FWD BLFC/BLFD	2183350L	Drive Shaft		31	41	58	121	1092
2.2 (74 kw)	2013.08-2018.12	6MT	F	L	Bus FWD DRF5/DRFF/DRFG	2183340L	Drive Shaft		31	41	58	121	752
	2013.08-2018.12	6MT	F	R	Bus FWD DRF5/DRFF/DRFG	2183350L	Drive Shaft		31	41	58	121	1092
	2013.08-2018.12	6MT	F	L	Platform/Chassis FWD DRF5/DRFF/DRFG	2183340L	Drive Shaft		31	41	58	121	752
	2013.08-2018.12	6MT	F	R	Platform/Chassis FWD DRF5/DRFF/DRFG	2183350L	Drive Shaft		31	41	58	121	1092
	2013.08-2018.12	6MT	F	L	Van FWD DRF5/DRFF/DRFG	2183340L	Drive Shaft		31	41	58	121	752
	2013.08-2018.12	6MT	F	R	Van FWD DRF5/DRFF/DRFG	2183350L	Drive Shaft		31	41	58	121	1092
2.2 (92 kw)	2013.08-2018.12	6MT	F	L	Bus FWD CY14/CYF5/CYFG/USF6	2183340L	Drive Shaft		31	41	58	121	752
	2013.08-2018.12	6MT	F	R	Bus FWD CY14/CYF5/CYFG/USF6	2183350L	Drive Shaft		31	41	58	121	1092
	2013.08-2018.12	6MT	F	L	Platform/Chassis FWD CY14/CYF5/CYFG/USF6	2183340L	Drive Shaft		31	41	58	121	752
	2013.08-2018.12	6MT	F	R	Platform/Chassis FWD CY14/CYF5/CYFG/USF6	2183350L	Drive Shaft		31	41	58	121	1092
	2013.08-2018.12	6MT	F	L	Van FWD CY14/CYF5/CYFG/USF6	2183340L	Drive Shaft		31	41	58	121	752
	2013.08-2018.12	6MT	F	R	Van FWD CY14/CYF5/CYFG/USF6	2183350L	Drive Shaft		31	41	58	121	1092
2.2 (114 kw)	2013.08-2018.12	6MT	F	L	Platform/Chassis FWD CVF5	2183340L	Drive Shaft		31	41	58	121	752
	2013.08-2018.12	6MT	F	R	Platform/Chassis FWD CVF5	2183350L	Drive Shaft		31	41	58	121	1092
	2013.08-2018.12	6MT	F	L	Van FWD CVF5	2183340L	Drive Shaft		31	41	58	121	752
	2013.08-2018.12	6MT	F	R	Van FWD CVF5	2183350L	Drive Shaft		31	41	58	121	1092
Transit 330													
2.0 (77 kw)	2016.03-	6MT	F	L	Van FWD BJFA/BJFB/YLFB/YLFA/YLFB/YLFS	2183340L	Drive Shaft		31	41	58	121	752
	2016.03-	6MT	F	R	Van FWD BJFA/BJFB/YLFB/YLFA/YLFB/YLFS	2183350L	Drive Shaft		31	41	58	121	1092
	2018.12-	6MT	F	L	Bus FWD BJFA/BJFB/YLFA/YLFB	2183340L	Drive Shaft		31	41	58	121	752
	2018.12-	6MT	F	R	Bus FWD BJFA/BJFB/YLFA/YLFB	2183350L	Drive Shaft		31	41	58	121	1092
2.0 (96 kw)	2016.03-	6MT	F	L	Bus FWD BKFA/BKFB/YMF6/YMFA/YMFB/YMFS	2183340L	Drive Shaft		31	41	58	121	752
	2016.03-	6MT	F	R	Bus FWD BKFA/BKFB/YMF6/YMFA/YMFB/YMFS	2183350L	Drive Shaft		31	41	58	121	1092
	2016.03-	6MT	F	L	Van FWD BKFA/BKFB/YMF6/YMFA/YMFB/YMFS	2183340L	Drive Shaft		31	41	58	121	752
	2016.03-	6MT	F	R	Van FWD BKFA/BKFB/YMF6/YMFA/YMFB/YMFS	2183350L	Drive Shaft		31	41	58	121	1092
	2019.05-	6MT	F	L	Bus FWD BKFC/BKFD	2183340L	Drive Shaft		31	41	58	121	752
	2019.05-	6MT	F	R	Bus FWD BKFC/BKFD	2183350L	Drive Shaft		31	41	58	121	1092
	2019.05-	6MT	F	L	Van FWD BKFC/BKFD	2183340L	Drive Shaft		31	41	58	121	752
	2019.05-	6MT	F	R	Van FWD BKFC/BKFD	2183350L	Drive Shaft		31	41	58	121	1092
2.0 (110 kw)	2021.10-	6MT	F	L	Bus FWD POFA	2183340L	Drive Shaft		31	41	58	121	752
	2021.10-	6MT	F	R	Bus FWD POFA	2183350L	Drive Shaft		31	41	58	121	1092
	2021.10-	6MT	F	L	Bus FWD P0FB	2183340L	Drive Shaft		31	41	58	121	752
	2021.10-	6MT	F	R	Bus FWD P0FB	2183350L	Drive Shaft		31	41	58	121	1092
2.0 (125 kw)	2016.03-	6MT	F	L	Van FWD BLFA/BLFB/YNF6/YNFA/YNFB/YNFS	2183340L	Drive Shaft		31	41	58	121	752
	2016.03-	6MT	F	R	Van FWD BLFA/BLFB/YNF6/YNFA/YNFB/YNFS	2183350L	Drive Shaft		31	41	58	121	1092
	2018.12-	6MT	F	L	Bus FWD BLFA/BLFB/YNFA/YNFB	2183340L	Drive Shaft		31	41	58	121	752
	2018.12-	6MT	F	R	Bus FWD BLFA/BLFB/YNFA/YNFB	2183350L	Drive Shaft		31	41	58	121	1092
	2019.05-	6MT	F	L	Bus FWD BLFC/BLFD	2183340L	Drive Shaft		31	41	58	121	752
	2019.05-	6MT	F	R	Bus FWD BLFC/BLFD	2183350L	Drive Shaft		31	41	58	121	1092
	2019.05-	6MT	F	L	Van FWD BLFC/BLFD	2183340L	Drive Shaft		31	41	58	121	752
	2019.05-	6MT	F	R	Van FWD BLFC/BLFD	2183350L	Drive Shaft		31	41	58	121	1092
2.2 (74 kw)	2013.08-2018.12	6MT	F	L	Bus FWD DRF5/DRFF/DRFG	2183340L	Drive Shaft		31	41	58	121	752
	2013.08-2018.12	6MT	F	R	Bus FWD DRF5/DRFF/DRFG	2183350L	Drive Shaft		31	41	58	121	1092
	2013.08-2018.12	6MT	F	L	Platform/Chassis FWD DRF5/DRFF/DRFG	2183340L	Drive Shaft		31	41	58	121	752
	2013.08-2018.12	6MT	F	R	Platform/Chassis FWD DRF5/DRFF/DRFG	2183350L	Drive Shaft		31	41	58	121	1092
	2013.08-2018.12	6MT	F	L	Van FWD DRF5/DRFF/DRFG	2183340L	Drive Shaft		31	41	58	121	752
	2013.08-2018.12	6MT	F	R	Van FWD DRF5/DRFF/DRFG	2183350L	Drive Shaft		31	41	58	121	1092
2.2 (92 kw)	2013.08-2018.12	6MT	F	L	Bus FWD CY14/CYF5/CYFG/USF6	2183340L	Drive Shaft		31	41	58	121	752
	2013.08-2018.12	6MT	F	R	Bus FWD CY14/CYF5/CYFG/USF6	2183350L	Drive Shaft		31	41	58	121	1092
	2013.08-2018.12	6MT	F	L	Platform/Chassis FWD CY14/CYF5/CYFG/USF6	2183340L	Drive Shaft		31	41	58	121	752
	2013.08-2018.12	6MT	F	R	Platform/Chassis FWD CY14/CYF5/CYFG/USF6	2183350L	Drive Shaft		31	41	58	121	1092
	2013.08-2018.12	6MT	F	L	Van FWD CY14/CYF5/CYFG/USF6	2183340L	Drive Shaft		31	41	58	121	752
	2013.08-2018.12	6MT	F	R	Van FWD CY14/CYF5/CYFG/USF6	2183350L	Drive Shaft		31	41	58	121	1092
2.2 (114 kw)	2013.08-2018.12	6MT	F	L	Van FWD CVF5	2183340L	Drive Shaft		31	41	58	121	752
	2013.08-2018.12	6MT	F	R	Van FWD CVF5	2183350L	Drive Shaft		31	41	58	121	1092
	2014.12-2018.12	6MT	F	L	Bus FWD CVF5	2183340L	Drive Shaft		31	41	58	121	752
	2014.12-2018.12	6MT	F	R	Bus FWD CVF5	2183350L	Drive Shaft		31	41	58	121	1092



  YEAR	TRANSM.	F/R	L/R	BODY STYLE & DRIVE TYPE & ENGINE	REMARKS	GSP Ref.	 PRODUCT	 ABS	Technical Specifications				
									A	B	C	H	L
FORD													
Transit 350													
2.0 (77 kw)													
2016.03-	6MT	F	L	Platform/Chassis FWD BJFA/BJFB/YLFA/YLFB/YLFS		2183340L	Drive Shaft		31	41	58	121	752
2016.03-	6MT	F	R	Platform/Chassis FWD BJFA/BJFB/YLFA/YLFB/YLFS		2183350L	Drive Shaft		31	41	58	121	1092
2016.03-	6MT	F	L	Van FWD BJFA/BJFB/YLFA/YLFB/YLFS		2183340L	Drive Shaft		31	41	58	121	752
2016.03-	6MT	F	R	Van FWD BJFA/BJFB/YLFA/YLFB/YLFS		2183350L	Drive Shaft		31	41	58	121	1092
2018.12-	6MT	F	L	Bus FWD BJFA/BJFB/YLFA/YLFB		2183340L	Drive Shaft		31	41	58	121	752
2018.12-	6MT	F	R	Bus FWD BJFA/BJFB/YLFA/YLFB		2183350L	Drive Shaft		31	41	58	121	1092
2.0 (96 kw)													
2016.03-	6MT	F	L	Bus FWD BKFA/BKFB/YMFA/YMFB/YMFS		2183340L	Drive Shaft		31	41	58	121	752
2016.03-	6MT	F	R	Bus FWD BKFA/BKFB/YMFA/YMFB/YMFS		2183350L	Drive Shaft		31	41	58	121	1092
2016.03-	6MT	F	L	Platform/Chassis FWD BKFA/BKFB/YMFA/YMFB/YMFS		2183340L	Drive Shaft		31	41	58	121	752
2016.03-	6MT	F	R	Platform/Chassis FWD BKFA/BKFB/YMFA/YMFB/YMFS		2183350L	Drive Shaft		31	41	58	121	1092
2016.03-	6MT	F	L	Van FWD BKFA/BKFB/YMFA/YMFB/YMFS		2183340L	Drive Shaft		31	41	58	121	752
2016.03-	6MT	F	R	Van FWD BKFA/BKFB/YMFA/YMFB/YMFS		2183350L	Drive Shaft		31	41	58	121	1092
2019.05-	6MT	F	L	Bus FWD BKFC/BKFD		2183340L	Drive Shaft		31	41	58	121	752
2019.05-	6MT	F	R	Bus FWD BKFC/BKFD		2183350L	Drive Shaft		31	41	58	121	1092
2019.05-	6MT	F	L	Platform/Chassis FWD BKFC/BKFD		2183340L	Drive Shaft		31	41	58	121	752
2019.05-	6MT	F	R	Platform/Chassis FWD BKFC/BKFD		2183350L	Drive Shaft		31	41	58	121	1092
2019.05-	6MT	F	L	Van FWD BKFC/BKFD		2183340L	Drive Shaft		31	41	58	121	752
2019.05-	6MT	F	R	Van FWD BKFC/BKFD		2183350L	Drive Shaft		31	41	58	121	1092
2.0 (110 kw)													
2021.10-	6MT	F	L	Bus FWD POFA		2183340L	Drive Shaft		31	41	58	121	752
2021.10-	6MT	F	R	Bus FWD POFA		2183350L	Drive Shaft		31	41	58	121	1092
2021.10-	6MT	F	L	Bus FWD POFB		2183340L	Drive Shaft		31	41	58	121	752
2021.10-	6MT	F	R	Bus FWD POFB		2183350L	Drive Shaft		31	41	58	121	1092
2.0 (118 kw)													
2021.01-	6MT	F	L	Platform/Chassis FWD NOHA		2183340L	Drive Shaft		31	41	58	121	752
2021.01-	6MT	F	R	Platform/Chassis FWD NOHA		2183350L	Drive Shaft		31	41	58	121	1092
2021.01-	6MT	F	L	Van FWD NOHA		2183340L	Drive Shaft		31	41	58	121	752
2021.01-	6MT	F	R	Van FWD NOHA		2183350L	Drive Shaft		31	41	58	121	1092
2.0 (125 kw)													
2016.03-	6MT	F	L	Platform/Chassis FWD BLFA/BLFB/YNFA/YNFB/YNFS		2183340L	Drive Shaft		31	41	58	121	752
2016.03-	6MT	F	R	Platform/Chassis FWD BLFA/BLFB/YNFA/YNFB/YNFS		2183350L	Drive Shaft		31	41	58	121	1092
2016.03-	6MT	F	L	Van FWD BLFA/BLFB/YNFA/YNFB/YNFS		2183340L	Drive Shaft		31	41	58	121	752
2016.03-	6MT	F	R	Van FWD BLFA/BLFB/YNFA/YNFB/YNFS		2183350L	Drive Shaft		31	41	58	121	1092
2018.12-	6MT	F	L	Bus FWD BLFA/BLFB/YNFA/YNFB		2183340L	Drive Shaft		31	41	58	121	752
2018.12-	6MT	F	R	Bus FWD BLFA/BLFB/YNFA/YNFB		2183350L	Drive Shaft		31	41	58	121	1092
2019.05-	6MT	F	L	Bus FWD BLFC/BLFD		2183340L	Drive Shaft		31	41	58	121	752
2019.05-	6MT	F	R	Bus FWD BLFC/BLFD		2183350L	Drive Shaft		31	41	58	121	1092
2019.05-	6MT	F	L	Platform/Chassis FWD BLFC/BLFD		2183340L	Drive Shaft		31	41	58	121	752
2019.05-	6MT	F	R	Platform/Chassis FWD BLFC/BLFD		2183350L	Drive Shaft		31	41	58	121	1092
2019.05-	6MT	F	L	Van FWD BLFC/BLFD		2183340L	Drive Shaft		31	41	58	121	752
2019.05-	6MT	F	R	Van FWD BLFC/BLFD		2183350L	Drive Shaft		31	41	58	121	1092
2.0 (136 kw)													
2019.05-	6MT	F	L	Platform/Chassis FWD BCFB		2183340L	Drive Shaft		31	41	58	121	752
2019.05-	6MT	F	R	Platform/Chassis FWD BCFB		2183350L	Drive Shaft		31	41	58	121	1092
2019.05-	6MT	F	L	Van FWD BCFB		2183340L	Drive Shaft		31	41	58	121	752
2019.05-	6MT	F	R	Van FWD BCFB		2183350L	Drive Shaft		31	41	58	121	1092
2.2 (74 kw)													
2013.08-2018.12	6MT	F	L	Bus FWD DRF5/DRFF/DRFG		2183340L	Drive Shaft		31	41	58	121	752
2013.08-2018.12	6MT	F	R	Bus FWD DRF5/DRFF/DRFG		2183350L	Drive Shaft		31	41	58	121	1092
2013.08-2018.12	6MT	F	L	Platform/Chassis FWD DRF5/DRFF/DRFG		2183340L	Drive Shaft		31	41	58	121	752
2013.08-2018.12	6MT	F	R	Platform/Chassis FWD DRF5/DRFF/DRFG		2183350L	Drive Shaft		31	41	58	121	1092
2013.08-2018.12	6MT	F	L	Van FWD DRF5/DRFF/DRFG		2183340L	Drive Shaft		31	41	58	121	752
2013.08-2018.12	6MT	F	R	Van FWD DRF5/DRFF/DRFG		2183350L	Drive Shaft		31	41	58	121	1092
2.2 (92 kw)													
2013.08-2018.12	6MT	F	L	Bus FWD CY14/CYF5/CYFG/USF6		2183340L	Drive Shaft		31	41	58	121	752
2013.08-2018.12	6MT	F	R	Bus FWD CY14/CYF5/CYFG/USF6		2183350L	Drive Shaft		31	41	58	121	1092
2013.08-2018.12	6MT	F	L	Platform/Chassis FWD CY14/CYF5/CYFG/USF6		2183340L	Drive Shaft		31	41	58	121	752
2013.08-2018.12	6MT	F	R	Platform/Chassis FWD CY14/CYF5/CYFG/USF6		2183350L	Drive Shaft		31	41	58	121	1092
2013.08-2018.12	6MT	F	L	Van FWD CY14/CYF5/CYFG/USF6		2183340L	Drive Shaft		31	41	58	121	752
2013.08-2018.12	6MT	F	R	Van FWD CY14/CYF5/CYFG/USF6		2183350L	Drive Shaft		31	41	58	121	1092
2.2 (114 kw)													
2013.08-2018.12	6MT	F	L	Platform/Chassis FWD CVF5		2183340L	Drive Shaft		31	41	58	121	752
2013.08-2018.12	6MT	F	R	Platform/Chassis FWD CVF5		2183350L	Drive Shaft		31	41	58	121	1092
2013.08-2018.12	6MT	F	L	Van FWD CVF5		2183340L	Drive Shaft		31	41	58	121	752
2013.08-2018.12	6MT	F	R	Van FWD CVF5		2183350L	Drive Shaft		31	41	58	121	1092
2014.12-2018.12	6MT	F	L	Bus FWD CVF5		2183340L	Drive Shaft		31	41	58	121	752
2014.12-2018.12	6MT	F	R	Bus FWD CVF5		2183350L	Drive Shaft		31	41	58	121	1092
Transit 410													
2.0 (118 kw)													
2021.01-	6MT	F	L	Van FWD NOHA		2183340L	Drive Shaft		31	41	58	121	752
2021.01-	6MT	F	R	Van FWD NOHA		2183350L	Drive Shaft		31	41	58	121	1092



  YEAR	TRANSM.	F/R	L/R	BODY STYLE & DRIVE TYPE & ENGINE	REMARKS	GSP Ref.	 PRODUCT ABS	Technical Specifications				
								A	B	C	H	L
FORD												
Transit Custom 250												
2.0 (77 kw)	2015.12-	6MT	F	L	Van FWD YLF6/YLFS	2183340L	Drive Shaft	31	41	58	121	752
	2015.12-	6MT	F	R	Van FWD YLF6/YLFS	2183350L	Drive Shaft	31	41	58	121	1092
2.2 (74 kw)	2012.09-2015.12	6MT	F	L	Van FWD DRFF/DRFG	2183340L	Drive Shaft	31	41	58	121	752
	2012.09-2015.12	6MT	F	R	Van FWD DRFF/DRFG	2183350L	Drive Shaft	31	41	58	121	1092
Transit Custom 260												
2.0 (77 kw)	2018.03-	6MT	F	L	Van FWD BJFA/BJFB/YLF6/YLFA/YLFB/YLFS	2183340L	Drive Shaft	31	41	58	121	752
	2018.03-	6MT	F	R	Van FWD BJFA/BJFB/YLF6/YLFA/YLFB/YLFS	2183350L	Drive Shaft	31	41	58	121	1092
Transit Custom 270												
2.0 (77 kw)	2015.12-	6MT	F	L	Van FWD YLF6/YLFS	2183340L	Drive Shaft	31	41	58	121	752
	2015.12-	6MT	F	R	Van FWD YLF6/YLFS	2183350L	Drive Shaft	31	41	58	121	1092
2.0 (96 kw)	2015.12-	6MT	F	L	Van FWD YMF6/YMFS	2183340L	Drive Shaft	31	41	58	121	752
	2015.12-	6MT	F	R	Van FWD YMF6/YMFS	2183350L	Drive Shaft	31	41	58	121	1092
2.0 (125 kw)	2015.12-	6MT	F	L	Van FWD YNF6/YNFS	2183340L	Drive Shaft	31	41	58	121	752
	2015.12-	6MT	F	R	Van FWD YNF6/YNFS	2183350L	Drive Shaft	31	41	58	121	1092
2.2 (74 kw)	2012.09-2015.12	6MT	F	L	Van FWD DRF4/DRFF/DRFG	2183340L	Drive Shaft	31	41	58	121	752
	2012.09-2015.12	6MT	F	R	Van FWD DRF4/DRFF/DRFG	2183350L	Drive Shaft	31	41	58	121	1092
2.2 (92 kw)	2012.09-2015.12	6MT	F	L	Van FWD CYF4/CYFF	2183340L	Drive Shaft	31	41	58	121	752
	2012.09-2015.12	6MT	F	R	Van FWD CYF4/CYFF	2183350L	Drive Shaft	31	41	58	121	1092
2.2 (114 kw)	2012.09-2015.12	6MT	F	L	Van FWD CVFF	2183340L	Drive Shaft	31	41	58	121	752
	2012.09-2015.12	6MT	F	R	Van FWD CVFF	2183350L	Drive Shaft	31	41	58	121	1092
Transit Custom 280												
2.0 (77 kw)	2018.03-	6MT	F	L	Van FWD BJFA/BJFB/YLF6/YLFA/YLFB/YLFS	2183340L	Drive Shaft	31	41	58	121	752
	2018.03-	6MT	F	R	Van FWD BJFA/BJFB/YLF6/YLFA/YLFB/YLFS	2183350L	Drive Shaft	31	41	58	121	1092
2.0 (96 kw)	2018.03-	6MT	F	L	Van FWD BKFA/BKFB/YMF6/YMFA/YMFB/YMFS	2183340L	Drive Shaft	31	41	58	121	752
	2018.03-	6MT	F	R	Van FWD BKFA/BKFB/YMF6/YMFA/YMFB/YMFS	2183350L	Drive Shaft	31	41	58	121	1092
	2019.05-	6MT	F	L	Van FWD BKFC/BKFD	2183340L	Drive Shaft	31	41	58	121	752
	2019.05-	6MT	F	R	Van FWD BKFC/BKFD	2183350L	Drive Shaft	31	41	58	121	1092
2.0 (125 kw)	2018.03-	6MT	F	L	Van FWD BLFA/BLFB/YNF6/YNFA/YNFB/YNFS	2183340L	Drive Shaft	31	41	58	121	752
	2018.03-	6MT	F	R	Van FWD BLFA/BLFB/YNF6/YNFA/YNFB/YNFS	2183350L	Drive Shaft	31	41	58	121	1092
	2019.05-	6MT	F	L	Van FWD BLFC/BLFD	2183340L	Drive Shaft	31	41	58	121	752
	2019.05-	6MT	F	R	Van FWD BLFC/BLFD	2183350L	Drive Shaft	31	41	58	121	1092
Transit Custom 290												
2.0 (77 kw)	2015.12-	6MT	F	L	Van FWD YLF6/YLFS	2183340L	Drive Shaft	31	41	58	121	752
	2015.12-	6MT	F	R	Van FWD YLF6/YLFS	2183350L	Drive Shaft	31	41	58	121	1092
2.0 (96 kw)	2015.12-	6MT	F	L	Van FWD YMF6/YMFS	2183340L	Drive Shaft	31	41	58	121	752
	2015.12-	6MT	F	R	Van FWD YMF6/YMFS	2183350L	Drive Shaft	31	41	58	121	1092
2.0 (125 kw)	2015.12-	6MT	F	L	Van FWD YNF6/YNFS	2183340L	Drive Shaft	31	41	58	121	752
	2015.12-	6MT	F	R	Van FWD YNF6/YNFS	2183350L	Drive Shaft	31	41	58	121	1092
2.0 (136 kw)	2019.05-	6MT	F	L	Van FWD BCFA/BCFB	2183340L	Drive Shaft	31	41	58	121	752
	2019.05-	6MT	F	R	Van FWD BCFA/BCFB	2183350L	Drive Shaft	31	41	58	121	1092
	2019.05-	6MT	F	L	Van FWD BCFC/BCFD	2183340L	Drive Shaft	31	41	58	121	752
	2019.05-	6MT	F	R	Van FWD BCFC/BCFD	2183350L	Drive Shaft	31	41	58	121	1092
2.2 (74 kw)	2012.09-2015.12	6MT	F	L	Van FWD DRF4/DRFF/DRFG	2183340L	Drive Shaft	31	41	58	121	752
	2012.09-2015.12	6MT	F	R	Van FWD DRF4/DRFF/DRFG	2183350L	Drive Shaft	31	41	58	121	1092
2.2 (92 kw)	2012.09-2015.12	6MT	F	L	Van FWD CYF4/CYFF	2183340L	Drive Shaft	31	41	58	121	752
	2012.09-2015.12	6MT	F	R	Van FWD CYF4/CYFF	2183350L	Drive Shaft	31	41	58	121	1092
2.2 (114 kw)	2012.09-2015.12	6MT	F	L	Van FWD CVFF	2183340L	Drive Shaft	31	41	58	121	752
	2012.09-2015.12	6MT	F	R	Van FWD CVFF	2183350L	Drive Shaft	31	41	58	121	1092
Transit Custom 300												
2.0 (77 kw)	2018.03-	6MT	F	L	Van FWD BJFA/BJFB/YLF6/YLFA/YLFB/YLFS	2183340L	Drive Shaft	31	41	58	121	752
	2018.03-	6MT	F	R	Van FWD BJFA/BJFB/YLF6/YLFA/YLFB/YLFS	2183350L	Drive Shaft	31	41	58	121	1092
2.0 (96 kw)	2018.03-	6MT	F	L	Van FWD BKFA/BKFB/YMF6/YMFA/YMFB/YMFS	2183340L	Drive Shaft	31	41	58	121	752
	2018.03-	6MT	F	R	Van FWD BKFA/BKFB/YMF6/YMFA/YMFB/YMFS	2183350L	Drive Shaft	31	41	58	121	1092
	2019.05-	6MT	F	L	Van FWD BKFC/BKFD	2183340L	Drive Shaft	31	41	58	121	752
	2019.05-	6MT	F	R	Van FWD BKFC/BKFD	2183350L	Drive Shaft	31	41	58	121	1092
2.0 (125 kw)	2018.03-	6MT	F	L	Van FWD BLFA/BLFB/YNF6/YNFA/YNFB/YNFS	2183340L	Drive Shaft	31	41	58	121	752
	2018.03-	6MT	F	R	Van FWD BLFA/BLFB/YNF6/YNFA/YNFB/YNFS	2183350L	Drive Shaft	31	41	58	121	1092
	2019.05-	6MT	F	L	Van FWD BLFC/BLFD	2183340L	Drive Shaft	31	41	58	121	752
	2019.05-	6MT	F	R	Van FWD BLFC/BLFD	2183350L	Drive Shaft	31	41	58	121	1092
2.2 (74 kw)	2012.09-2015.12	6MT	F	L	Bus FWD DRF4/DRFF/DRFG	2183340L	Drive Shaft	31	41	58	121	752
	2012.09-2015.12	6MT	F	R	Bus FWD DRF4/DRFF/DRFG	2183350L	Drive Shaft	31	41	58	121	1092
2.2 (92 kw)	2012.09-2015.12	6MT	F	L	Bus FWD CYF4/CYFF	2183340L	Drive Shaft	31	41	58	121	752
	2012.09-2015.12	6MT	F	R	Bus FWD CYF4/CYFF	2183350L	Drive Shaft	31	41	58	121	1092
2.2 (114 kw)	2012.09-2015.12	6MT	F	L	Bus FWD CVFF	2183340L	Drive Shaft	31	41	58	121	752
	2012.09-2015.12	6MT	F	R	Bus FWD CVFF	2183350L	Drive Shaft	31	41	58	121	1092





	 YEAR	TRANSM.	F/R	L/R	BODY STYLE & DRIVE TYPE & ENGINE	REMARKS	GSP Ref.	 PRODUCT	 ABS	Technical Specifications				
										A	B	C	H	L
FORD														
Transit Custom 310														
2.0 (77 kw)	2015.12-	6MT	F	L	Bus FWD YLF6/YLFS		2183340L	Drive Shaft		31	41	58	121	752
	2015.12-	6MT	F	R	Bus FWD YLF6/YLFS		2183350L	Drive Shaft		31	41	58	121	1092
	2015.12-	6MT	F	L	Van FWD YLF6/YLFS		2183340L	Drive Shaft		31	41	58	121	752
	2015.12-	6MT	F	R	Van FWD YLF6/YLFS		2183350L	Drive Shaft		31	41	58	121	1092
2.0 (96 kw)	2015.12-	6MT	F	L	Bus FWD YMF6/YMFS		2183340L	Drive Shaft		31	41	58	121	752
	2015.12-	6MT	F	R	Bus FWD YMF6/YMFS		2183350L	Drive Shaft		31	41	58	121	1092
	2015.12-	6MT	F	L	Van FWD YMF6/YMFS		2183340L	Drive Shaft		31	41	58	121	752
	2015.12-	6MT	F	R	Van FWD YMF6/YMFS		2183350L	Drive Shaft		31	41	58	121	1092
2.0 (125 kw)	2015.12-	6MT	F	L	Bus FWD YNF6/YNFS		2183340L	Drive Shaft		31	41	58	121	752
	2015.12-	6MT	F	R	Bus FWD YNF6/YNFS		2183350L	Drive Shaft		31	41	58	121	1092
	2015.12-	6MT	F	L	Van FWD YNF6/YNFS		2183340L	Drive Shaft		31	41	58	121	752
	2015.12-	6MT	F	R	Van FWD YNF6/YNFS		2183350L	Drive Shaft		31	41	58	121	1092
2.0 (136 kw)	2019.05-	6MT	F	L	Van FWD BCFA/BCFB		2183340L	Drive Shaft		31	41	58	121	752
	2019.05-	6MT	F	R	Van FWD BCFA/BCFB		2183350L	Drive Shaft		31	41	58	121	1092
	2019.05-	6MT	F	L	Van FWD BCFC/BCFD		2183340L	Drive Shaft		31	41	58	121	752
	2019.05-	6MT	F	R	Van FWD BCFC/BCFD		2183350L	Drive Shaft		31	41	58	121	1092
2.2 (74 kw)	2012.09-2015.12	6MT	F	L	Bus FWD DRF4/DRFF/DRFG		2183340L	Drive Shaft		31	41	58	121	752
	2012.09-2015.12	6MT	F	R	Bus FWD DRF4/DRFF/DRFG		2183350L	Drive Shaft		31	41	58	121	1092
	2012.09-2015.12	6MT	F	L	Van FWD DRF4/DRFF/DRFG		2183340L	Drive Shaft		31	41	58	121	752
	2012.09-2015.12	6MT	F	R	Van FWD DRF4/DRFF/DRFG		2183350L	Drive Shaft		31	41	58	121	1092
2.2 (92 kw)	2012.09-2015.12	6MT	F	L	Bus FWD CYF4/CYFF		2183340L	Drive Shaft		31	41	58	121	752
	2012.09-2015.12	6MT	F	R	Bus FWD CYF4/CYFF		2183350L	Drive Shaft		31	41	58	121	1092
	2012.09-2015.12	6MT	F	L	Van FWD CYF4/CYFF		2183340L	Drive Shaft		31	41	58	121	752
	2012.09-2015.12	6MT	F	R	Van FWD CYF4/CYFF		2183350L	Drive Shaft		31	41	58	121	1092
2.2 (114 kw)	2012.09-2015.12	6MT	F	L	Bus FWD CVFF		2183340L	Drive Shaft		31	41	58	121	752
	2012.09-2015.12	6MT	F	R	Bus FWD CVFF		2183350L	Drive Shaft		31	41	58	121	1092
	2012.09-2015.12	6MT	F	L	Van FWD CVFF		2183340L	Drive Shaft		31	41	58	121	752
	2012.09-2015.12	6MT	F	R	Van FWD CVFF		2183350L	Drive Shaft		31	41	58	121	1092
Transit Custom 320														
2.0 (77 kw)	2018.03-	6MT	F	L	Bus FWD BJFA/BJFB/YLF6/YLFA/YLFB/YLFS		2183340L	Drive Shaft		31	41	58	121	752
	2018.03-	6MT	F	R	Bus FWD BJFA/BJFB/YLF6/YLFA/YLFB/YLFS		2183350L	Drive Shaft		31	41	58	121	1092
	2018.03-	6MT	F	L	Van FWD BJFA/BJFB/YLF6/YLFA/YLFB/YLFS		2183340L	Drive Shaft		31	41	58	121	752
	2018.03-	6MT	F	R	Van FWD BJFA/BJFB/YLF6/YLFA/YLFB/YLFS		2183350L	Drive Shaft		31	41	58	121	1092
	2019.05-	6MT	F	L	Bus FWD BJFC/BJFD		2183340L	Drive Shaft		31	41	58	121	752
	2019.05-	6MT	F	R	Bus FWD BJFC/BJFD		2183350L	Drive Shaft		31	41	58	121	1092
2.0 (96 kw)	2018.03-	6MT	F	L	Bus FWD BKFA/BKFB/YMF6/YMFA/YMFB/YMFS		2183340L	Drive Shaft		31	41	58	121	752
	2018.03-	6MT	F	R	Bus FWD BKFA/BKFB/YMF6/YMFA/YMFB/YMFS		2183350L	Drive Shaft		31	41	58	121	1092
	2018.03-	6MT	F	L	Van FWD BKFA/BKFB/YMF6/YMFA/YMFB/YMFS		2183340L	Drive Shaft		31	41	58	121	752
	2018.03-	6MT	F	R	Van FWD BKFA/BKFB/YMF6/YMFA/YMFB/YMFS		2183350L	Drive Shaft		31	41	58	121	1092
	2019.05-	6MT	F	L	Bus FWD BKFC/BKFD		2183340L	Drive Shaft		31	41	58	121	752
	2019.05-	6MT	F	R	Bus FWD BKFC/BKFD		2183350L	Drive Shaft		31	41	58	121	1092
	2019.05-	6MT	F	L	Van FWD BKFC/BKFD		2183340L	Drive Shaft		31	41	58	121	752
	2019.05-	6MT	F	R	Van FWD BKFC/BKFD		2183350L	Drive Shaft		31	41	58	121	1092
2.0 (125 kw)	2018.03-	6MT	F	L	Bus FWD BLFA/BLFB/YNF6/YNFA/YNFB/YNFS		2183340L	Drive Shaft		31	41	58	121	752
	2018.03-	6MT	F	R	Bus FWD BLFA/BLFB/YNF6/YNFA/YNFB/YNFS		2183350L	Drive Shaft		31	41	58	121	1092
	2018.03-	6MT	F	L	Van FWD BLFA/BLFB/YNF6/YNFA/YNFB/YNFS		2183340L	Drive Shaft		31	41	58	121	752
	2018.03-	6MT	F	R	Van FWD BLFA/BLFB/YNF6/YNFA/YNFB/YNFS		2183350L	Drive Shaft		31	41	58	121	1092
	2019.05-	6MT	F	L	Bus FWD BLFC/BLFD		2183340L	Drive Shaft		31	41	58	121	752
	2019.05-	6MT	F	R	Bus FWD BLFC/BLFD		2183350L	Drive Shaft		31	41	58	121	1092
	2019.05-	6MT	F	L	Van FWD BLFC/BLFD		2183340L	Drive Shaft		31	41	58	121	752
	2019.05-	6MT	F	R	Van FWD BLFC/BLFD		2183350L	Drive Shaft		31	41	58	121	1092
2.0 (136 kw)	2019.05-	6MT	F	L	Bus FWD BCFA/BCFB		2183340L	Drive Shaft		31	41	58	121	752
	2019.05-	6MT	F	R	Bus FWD BCFA/BCFB		2183350L	Drive Shaft		31	41	58	121	1092
	2019.05-	6MT	F	L	Bus FWD BCFC/BCFD		2183340L	Drive Shaft		31	41	58	121	752
	2019.05-	6MT	F	R	Bus FWD BCFC/BCFD		2183350L	Drive Shaft		31	41	58	121	1092
	2019.05-	6MT	F	L	Van FWD BCFA/BCFB		2183340L	Drive Shaft		31	41	58	121	752
	2019.05-	6MT	F	R	Van FWD BCFA/BCFB		2183350L	Drive Shaft		31	41	58	121	1092
Transit Custom 330														
2.2 (92 kw)	2012.09-2015.12	6MT	F	L	Bus FWD CYF4/CYFF		2183340L	Drive Shaft		31	41	58	121	752
	2012.09-2015.12	6MT	F	R	Bus FWD CYF4/CYFF		2183350L	Drive Shaft		31	41	58	121	1092
	2012.09-2015.12	6MT	F	L	Van FWD CYF4/CYFF		2183340L	Drive Shaft		31	41	58	121	752
	2012.09-2015.12	6MT	F	R	Van FWD CYF4/CYFF		2183350L	Drive Shaft		31	41	58	121	1092
2.2 (114 kw)	2012.09-2015.12	6MT	F	L	Bus FWD CVFF		2183340L	Drive Shaft		31	41	58	121	752
	2012.09-2015.12	6MT	F	R	Bus FWD CVFF		2183350L	Drive Shaft		31	41	58	121	1092
	2012.09-2015.12	6MT	F	L	Van FWD CVFF		2183340L	Drive Shaft		31	41	58	121	752





		TRANSM.	F/R	L/R	BODY STYLE & DRIVE TYPE & ENGINE	REMARKS	GSP Ref.		PRODUCT	ABS	Technical Specifications				
											A	B	C	H	L
FORD															
Transit Custom 330															
2.2 (114 kw)	2012.09-2015.12	6MT	F	R	Van FWD CVFF		2183350L	Drive Shaft			31	41	58	121	1092
Transit Custom 340															
2.0 (96 kw)	2015.12-	6MT	F	L	Bus FWD BKFA/BKFB/YMFB/YMFA/YMFB/YMFS		2183340L	Drive Shaft			31	41	58	121	752
	2015.12-	6MT	F	R	Bus FWD BKFA/BKFB/YMFB/YMFA/YMFB/YMFS		2183350L	Drive Shaft			31	41	58	121	1092
	2015.12-	6MT	F	L	Van FWD BKFA/BKFB/YMFB/YMFA/YMFB/YMFS		2183340L	Drive Shaft			31	41	58	121	752
	2015.12-	6MT	F	R	Van FWD BKFA/BKFB/YMFB/YMFA/YMFB/YMFS		2183350L	Drive Shaft			31	41	58	121	1092
	2019.05-	6MT	F	L	Bus FWD BKFC/BKFD		2183340L	Drive Shaft			31	41	58	121	752
	2019.05-	6MT	F	R	Bus FWD BKFC/BKFD		2183350L	Drive Shaft			31	41	58	121	1092
	2019.05-	6MT	F	L	Van FWD BKFC/BKFD		2183340L	Drive Shaft			31	41	58	121	752
	2019.05-	6MT	F	R	Van FWD BKFC/BKFD		2183350L	Drive Shaft			31	41	58	121	1092
2.0 (125 kw)	2015.12-	6MT	F	L	Bus FWD BLFA/BLFB/YNFB/YNFA/YNFB/YNFS		2183340L	Drive Shaft			31	41	58	121	752
	2015.12-	6MT	F	R	Bus FWD BLFA/BLFB/YNFB/YNFA/YNFB/YNFS		2183350L	Drive Shaft			31	41	58	121	1092
	2015.12-	6MT	F	L	Van FWD BLFA/BLFB/YNFB/YNFA/YNFB/YNFS		2183340L	Drive Shaft			31	41	58	121	752
	2015.12-	6MT	F	R	Van FWD BLFA/BLFB/YNFB/YNFA/YNFB/YNFS		2183350L	Drive Shaft			31	41	58	121	1092
	2019.05-	6MT	F	L	Bus FWD BLFC/BLFD		2183340L	Drive Shaft			31	41	58	121	752
	2019.05-	6MT	F	R	Bus FWD BLFC/BLFD		2183350L	Drive Shaft			31	41	58	121	1092
	2019.05-	6MT	F	L	Van FWD BLFC/BLFD		2183340L	Drive Shaft			31	41	58	121	752
	2019.05-	6MT	F	R	Van FWD BLFC/BLFD		2183350L	Drive Shaft			31	41	58	121	1092
2.0 (136 kw)	2019.05-	6MT	F	L	Bus FWD BCFA/BCFB		2183340L	Drive Shaft			31	41	58	121	752
	2019.05-	6MT	F	R	Bus FWD BCFA/BCFB		2183350L	Drive Shaft			31	41	58	121	1092
	2019.05-	6MT	F	L	Bus FWD BCFC/BCFD		2183340L	Drive Shaft			31	41	58	121	752
	2019.05-	6MT	F	R	Bus FWD BCFC/BCFD		2183350L	Drive Shaft			31	41	58	121	1092
FORD USA															
Ranger															
2.0 (96 kw)	2019.03-	6MT	F	L	Pick up 4WD T20DD0J		2342210L	Drive Shaft			28	29	61	104	609
	2019.03-	6MT	F	R	Pick up 4WD T20DD0J		2342200L	Drive Shaft			28	29	61	104	566
2.0 (125 kw)	2019.03-	10AT/6MT	F	L	Pick up 4WD T20DD0J		2342210L	Drive Shaft			28	29	61	104	609
	2019.03-	10AT/6MT	F	R	Pick up 4WD T20DD0J		2342200L	Drive Shaft			28	29	61	104	566
2.2 (92 kw)	2011.04-	AT/MT	F	L	Pick up 4WD GBVAJQW		2342210L	Drive Shaft			28	29	61	104	609
	2011.04-	AT/MT	F	R	Pick up 4WD GBVAJQW		2342200L	Drive Shaft			28	29	61	104	566
2.2 (96 kw)	2015.05-	AT/MT	F	L	Pick up 4WD T22DD0P		2342210L	Drive Shaft			28	29	61	104	609
	2015.05-	AT/MT	F	R	Pick up 4WD T22DD0P		2342200L	Drive Shaft			28	29	61	104	566
2.2 (110 kw)	2011.04-	AT/MT	F	L	Pick up 4WD GBVAJQJ		2342210L	Drive Shaft			28	29	61	104	609
	2011.04-	AT/MT	F	R	Pick up 4WD GBVAJQJ		2342200L	Drive Shaft			28	29	61	104	566
2.2 (118 kw)	2015.05-	AT/MT	F	L	Pick up 4WD GBVAJQJ/T22DD0P		2342210L	Drive Shaft			28	29	61	104	609
	2015.05-	AT/MT	F	R	Pick up 4WD GBVAJQJ/T22DD0P		2342200L	Drive Shaft			28	29	61	104	566
2.5 (122 kw)	2011.11-	MT	F	L	Pick up 4WD GBVAF/GBVAK/GBVAL		2342210L	Drive Shaft			28	29	61	104	609
	2011.11-	MT	F	R	Pick up 4WD GBVAF/GBVAK/GBVAL		2342200L	Drive Shaft			28	29	61	104	566
3.2 (147 kw)	2011.04-	AT/MT	F	L	Pick up 4WD SA2R/SA2S/SA2W/SAFA		2342210L	Drive Shaft			28	29	61	104	609
	2011.04-	AT/MT	F	R	Pick up 4WD SA2R/SA2S/SA2W/SAFA		2342200L	Drive Shaft			28	29	61	104	566
HONDA															
CR-V															
2.0 (110 kw)	2017.09-	CVT	R	L	SUV 4WD R20Z9	Model year to:2019	2031030L	Drive Shaft			23	20	52	88	797
	2017.09-	CVT	R	R	SUV 4WD R20Z9	Model year to:2019	2031020L	Drive Shaft			23	20	52	88	841
2.4 (137 kw)	2017.09-	CVT	R	L	SUV 4WD K24W9	Model year to:2019	2031030L	Drive Shaft			23	20	52	88	797
	2017.09-	CVT	R	R	SUV 4WD K24W9	Model year to:2019	2031020L	Drive Shaft			23	20	52	88	841
LAND ROVER															
Defender 110															
2.0 (147 kw)	2019.09-	8AT	R	L	Terrain cab wagon closed 4WD 204DT		2023460L	Drive Shaft			31	31	68.2	97	838
	2019.09-	8AT	R	R	Terrain cab wagon closed 4WD 204DT		2023450L	Drive Shaft			31	31	68.2	97	860
	2020.02-	8AT	R	L	Terrain cab wagon closed Van 4WD 204DT		2023460L	Drive Shaft			31	31	68.2	97	838
	2020.02-	8AT	R	R	Terrain cab wagon closed Van 4WD 204DT		2023450L	Drive Shaft			31	31	68.2	97	860
2.0 (177 kw)	2019.09-	8AT	R	L	Terrain cab wagon closed 4WD 204DT		2023460L	Drive Shaft			31	31	68.2	97	838
	2019.09-	8AT	R	R	Terrain cab wagon closed 4WD 204DT		2023450L	Drive Shaft			31	31	68.2	97	860
	2020.02-	8AT	R	L	Terrain cab wagon closed Van 4WD 204DT		2023460L	Drive Shaft			31	31	68.2	97	838
	2020.02-	8AT	R	R	Terrain cab wagon closed Van 4WD 204DT		2023450L	Drive Shaft			31	31	68.2	97	860
2.0 (221 kw)	2019.09-	8AT	R	L	Terrain cab wagon closed 4WD PT204		2023460L	Drive Shaft			31	31	68.2	97	838
	2019.09-	8AT	R	R	Terrain cab wagon closed 4WD PT204		2023450L	Drive Shaft			31	31	68.2	97	860
	2020.02-	8AT	R	L	Terrain cab wagon closed Van 4WD PT204		2023460L	Drive Shaft			31	31	68.2	97	838
	2020.02-	8AT	R	R	Terrain cab wagon closed Van 4WD PT204		2023450L	Drive Shaft			31	31	68.2	97	860
	2020.09-	8AT	R	L	Terrain cab wagon closed 4WD PT204		2023460L	Drive Shaft			31	31	68.2	97	838
	2020.09-	8AT	R	R	Terrain cab wagon closed 4WD PT204		2023450L	Drive Shaft			31	31	68.2	97	860
	2020.09-	8AT	R	L	Terrain cab wagon closed Van 4WD PT204		2023460L	Drive Shaft			31	31	68.2	97	838
	2020.09-	8AT	R	R	Terrain cab wagon closed Van 4WD PT204		2023450L	Drive Shaft			31	31	68.2	97	860
3.0 (147 kw)	2020.09-	8AT	R	L	Terrain cab wagon closed 4WD AJ20D6		2023460L	Drive Shaft			31	31	68.2	97	838





	 YEAR	TRANSM.	F/R	L/R	BODY STYLE & DRIVE TYPE & ENGINE	REMARKS	GSP Ref.	 PRODUCT ABS	Technical Specifications				
									A	B	C	H	L
LAND ROVER													
Defender 110													
3.0 (147 kw)	2020.09-	8AT	R	R	Terrain cab wagon closed 4WD AJ20D6		2023450L	Drive Shaft	31	31	68.2	97	860
	2020.09-	8AT	R	L	Terrain cab wagon closed Van 4WD AJ20D6		2023460L	Drive Shaft	31	31	68.2	97	838
	2020.09-	8AT	R	R	Terrain cab wagon closed Van 4WD AJ20D6		2023450L	Drive Shaft	31	31	68.2	97	860
3.0 (183 kw)	2020.09-	8AT	R	L	Terrain cab wagon closed 4WD AJ20D6		2023460L	Drive Shaft	31	31	68.2	97	838
	2020.09-	8AT	R	R	Terrain cab wagon closed 4WD AJ20D6		2023450L	Drive Shaft	31	31	68.2	97	860
	2020.09-	8AT	R	L	Terrain cab wagon closed Van 4WD AJ20D6		2023460L	Drive Shaft	31	31	68.2	97	838
3.0 (221 kw)	2020.09-	8AT	R	R	Terrain cab wagon closed Van 4WD AJ20D6		2023450L	Drive Shaft	31	31	68.2	97	860
	2020.09-	8AT	R	L	Terrain cab wagon closed 4WD AJ20D6		2023460L	Drive Shaft	31	31	68.2	97	838
	2020.09-	8AT	R	R	Terrain cab wagon closed Van 4WD AJ20D6		2023450L	Drive Shaft	31	31	68.2	97	860
3.0 (294 kw)	2020.09-	8AT	R	L	Terrain cab wagon closed 4WD AJ20D6		2023460L	Drive Shaft	31	31	68.2	97	838
	2020.09-	8AT	R	R	Terrain cab wagon closed 4WD AJ20D6		2023450L	Drive Shaft	31	31	68.2	97	860
	2020.09-	8AT	R	L	Terrain cab wagon closed Van 4WD AJ20D6		2023460L	Drive Shaft	31	31	68.2	97	838
5.0 (386 kw)	2021.05-	8AT	R	L	Terrain cab wagon closed 4WD 508PS		2023460L	Drive Shaft	31	31	68.2	97	838
	2021.05-	8AT	R	R	Terrain cab wagon closed 4WD 508PS		2023450L	Drive Shaft	31	31	68.2	97	860
	2021.05-	8AT	R	R	Terrain cab wagon closed 4WD 508PS		2023450L	Drive Shaft	31	31	68.2	97	860
Defender 130													
3.0 (183 kw)	2020.09-	AT	R	L	Terrain cab wagon closed 4WD AJ20D6	Chassis no. to:L2999999	2023460L	Drive Shaft	31	31	68.2	97	838
	2020.09-	AT	R	R	Terrain cab wagon closed 4WD AJ20D6		2023450L	Drive Shaft	31	31	68.2	97	860
3.0 (221 kw)	2020.09-	AT	R	L	Terrain cab wagon closed 4WD AJ20D6	Chassis no. to:L2999999	2023460L	Drive Shaft	31	31	68.2	97	838
	2020.09-	AT	R	R	Terrain cab wagon closed 4WD AJ20D6		2023450L	Drive Shaft	31	31	68.2	97	860
	2022.05-	AT	R	L	Terrain cab wagon closed 4WD AJ20P6		2023460L	Drive Shaft	31	31	68.2	97	838
3.0 (294 kw)	2022.05-	AT	R	R	Terrain cab wagon closed 4WD AJ20P6		2023450L	Drive Shaft	31	31	68.2	97	860
	2019.09-	AT	R	L	Terrain cab wagon closed 4WD PT306		2023460L	Drive Shaft	31	31	68.2	97	838
2019.09-	AT	R	R	Terrain cab wagon closed 4WD PT306		2023450L	Drive Shaft	31	31	68.2	97	860	
Defender 90													
2.0 (147 kw)	2019.09-	8AT	R	L	Terrain cab wagon closed 4WD 204DT		2023460L	Drive Shaft	31	31	68.2	97	838
	2019.09-	8AT	R	R	Terrain cab wagon closed 4WD 204DT		2023450L	Drive Shaft	31	31	68.2	97	860
	2020.02-	8AT	R	L	Terrain cab wagon closed Van 4WD 204DT		2023460L	Drive Shaft	31	31	68.2	97	838
	2020.02-	8AT	R	R	Terrain cab wagon closed Van 4WD 204DT		2023450L	Drive Shaft	31	31	68.2	97	860
2.0 (177 kw)	2019.09-	8AT	R	L	Terrain cab wagon closed 4WD 204DT		2023460L	Drive Shaft	31	31	68.2	97	838
	2019.09-	8AT	R	R	Terrain cab wagon closed 4WD 204DT		2023450L	Drive Shaft	31	31	68.2	97	860
	2020.02-	8AT	R	L	Terrain cab wagon closed Van 4WD 204DT		2023460L	Drive Shaft	31	31	68.2	97	838
	2020.02-	8AT	R	R	Terrain cab wagon closed Van 4WD 204DT		2023450L	Drive Shaft	31	31	68.2	97	860
2.0 (221 kw)	2019.09-	8AT	R	L	Terrain cab wagon closed 4WD PT204		2023460L	Drive Shaft	31	31	68.2	97	838
	2019.09-	8AT	R	R	Terrain cab wagon closed 4WD PT204		2023450L	Drive Shaft	31	31	68.2	97	860
	2020.02-	8AT	R	L	Terrain cab wagon closed Van 4WD PT204		2023460L	Drive Shaft	31	31	68.2	97	838
	2020.02-	8AT	R	R	Terrain cab wagon closed Van 4WD PT204		2023450L	Drive Shaft	31	31	68.2	97	860
3.0 (147 kw)	2020.09-	8AT	R	L	Terrain cab wagon closed 4WD AJ20D6		2023460L	Drive Shaft	31	31	68.2	97	838
	2020.09-	8AT	R	R	Terrain cab wagon closed 4WD AJ20D6		2023450L	Drive Shaft	31	31	68.2	97	860
	2020.09-	8AT	R	L	Terrain cab wagon closed Van 4WD AJ20D6		2023460L	Drive Shaft	31	31	68.2	97	838
	2020.09-	8AT	R	R	Terrain cab wagon closed Van 4WD AJ20D6		2023450L	Drive Shaft	31	31	68.2	97	860
3.0 (183 kw)	2020.09-	8AT	R	L	Terrain cab wagon closed 4WD AJ20D6		2023460L	Drive Shaft	31	31	68.2	97	838
	2020.09-	8AT	R	R	Terrain cab wagon closed 4WD AJ20D6		2023450L	Drive Shaft	31	31	68.2	97	860
	2020.09-	8AT	R	L	Terrain cab wagon closed Van 4WD AJ20D6		2023460L	Drive Shaft	31	31	68.2	97	838
	2020.09-	8AT	R	R	Terrain cab wagon closed Van 4WD AJ20D6		2023450L	Drive Shaft	31	31	68.2	97	860
3.0 (221 kw)	2020.09-	8AT	R	L	Terrain cab wagon closed 4WD AJ20D6		2023460L	Drive Shaft	31	31	68.2	97	838
	2020.09-	8AT	R	R	Terrain cab wagon closed 4WD AJ20D6		2023450L	Drive Shaft	31	31	68.2	97	860
	2020.09-	8AT	R	L	Terrain cab wagon closed Van 4WD AJ20D6		2023460L	Drive Shaft	31	31	68.2	97	838
	2020.09-	8AT	R	R	Terrain cab wagon closed Van 4WD AJ20D6		2023450L	Drive Shaft	31	31	68.2	97	860
3.0 (294 kw)	2019.09-	8AT	R	L	Terrain cab wagon closed 4WD PT306		2023460L	Drive Shaft	31	31	68.2	97	838
	2019.09-	8AT	R	R	Terrain cab wagon closed 4WD PT306		2023450L	Drive Shaft	31	31	68.2	97	860
	2020.02-	8AT	R	L	Terrain cab wagon closed Van 4WD PT306		2023460L	Drive Shaft	31	31	68.2	97	838
	2020.02-	8AT	R	R	Terrain cab wagon closed Van 4WD PT306		2023450L	Drive Shaft	31	31	68.2	97	860
5.0 (386 kw)	2021.05-	8AT	R	L	Terrain cab wagon closed 4WD 508PS		2023460L	Drive Shaft	31	31	68.2	97	838
	2021.05-	8AT	R	R	Terrain cab wagon closed 4WD 508PS		2023450L	Drive Shaft	31	31	68.2	97	860
Discovery													
2.0 (132 kw)	2016.09-2018.12	8AT	R	L	SUV 4WD 204DTD		2023460L	Drive Shaft	31	31	68.2	97	838
	2016.09-2018.12	8AT	R	R	SUV 4WD 204DTD		2023450L	Drive Shaft	31	31	68.2	97	860
	2016.09-2018.12	8AT	R	L	SUV Van 4WD 204DTD		2023460L	Drive Shaft	31	31	68.2	97	838
	2016.09-2018.12	8AT	R	R	SUV Van 4WD 204DTD		2023450L	Drive Shaft	31	31	68.2	97	860
2.0 (177 kw)	2016.09-	8AT	R	L	SUV 4WD 204DTA		2023460L	Drive Shaft	31	31	68.2	97	838
	2016.09-	8AT	R	R	SUV 4WD 204DTA		2023450L	Drive Shaft	31	31	68.2	97	860
	2016.09-	8AT	R	L	SUV Van 4WD 204DTA		2023460L	Drive Shaft	31	31	68.2	97	838



		TRANSM.	F/R	L/R	BODY STYLE & DRIVE TYPE & ENGINE	REMARKS	GSP Ref.		ABS	Technical Specifications				
										A	B	C	H	L
LAND ROVER														
Discovery														
2.0 (177 kw)	2016.09-	8AT	R	R	SUV Van 4WD 204DTA		2023450L	Drive Shaft		31	31	68.2	97	860
2.0 (221 kw)	2017.09-	8AT	R	L	SUV 4WD PT204		2023460L	Drive Shaft		31	31	68.2	97	838
	2017.09-	8AT	R	R	SUV 4WD PT204		2023450L	Drive Shaft		31	31	68.2	97	860
	2017.09-	8AT	R	L	SUV Van 4WD PT204		2023460L	Drive Shaft		31	31	68.2	97	838
	2017.09-	8AT	R	R	SUV Van 4WD PT204		2023450L	Drive Shaft		31	31	68.2	97	860
2.7 (140 kw)	2004.07-2009.08	Semi-AT	F	L	Terrain cab wagon closed 4WD 276DT		2595350L	Drive Shaft	48T	29	29	74	96	639
	2004.07-2009.08	Semi-AT	F	R	Terrain cab wagon closed 4WD 276DT		2596230L	Drive Shaft	48T	29	29	74	96	998
	2007.01-2009.07	6MT	F	L	Van 4WD 276DT		2595350L	Drive Shaft	48T	29	29	74	96	639
	2007.01-2009.07	6MT	F	R	Van 4WD 276DT		2596230L	Drive Shaft	48T	29	29	74	96	998
	2009.09-2018.12	6AT	F	L	Terrain cab wagon closed 4WD 276DT		2595350L	Drive Shaft	48T	29	29	74	96	639
	2009.09-2018.12	6AT/6MT	F	R	Terrain cab wagon closed 4WD 276DT		2596230L	Drive Shaft	48T	29	29	74	96	998
3.0 (155 kw)	2009.09-2018.12	6AT/8AT	F	L	Terrain cab wagon closed 4WD 306DT		2595350L	Drive Shaft	48T	29	29	74	96	639
	2009.09-2018.12	6AT/8AT	F	R	Terrain cab wagon closed 4WD 306DT		2596230L	Drive Shaft	48T	29	29	74	96	998
	2011.01-2017.12	6AT	F	L	Van 4WD 306DT		2595350L	Drive Shaft	48T	29	29	74	96	639
	2011.01-2017.12	6AT	F	R	Van 4WD 306DT		2596230L	Drive Shaft	48T	29	29	74	96	998
	2016.09-	8AT	R	L	SUV 4WD 306DT		2023460L	Drive Shaft		31	31	68.2	97	838
	2016.09-	8AT	R	R	SUV 4WD 306DT		2023450L	Drive Shaft		31	31	68.2	97	860
3.0 (180 kw)	2009.09-2018.12	6AT	F	L	Terrain cab wagon closed 4WD 306DT		2595350L	Drive Shaft	48T	29	29	74	96	639
	2009.09-2018.12	6AT	F	R	Terrain cab wagon closed 4WD 306DT		2596230L	Drive Shaft	48T	29	29	74	96	998
	2011.01-2011.12	6AT	F	L	Van 4WD 306DT		2595350L	Drive Shaft	48T	29	29	74	96	639
	2011.01-2011.12	6AT	F	R	Van 4WD 306DT		2596230L	Drive Shaft	48T	29	29	74	96	998
3.0 (183 kw)	2013.01-2018.12	6AT/8AT	F	L	Terrain cab wagon closed 4WD 306DT		2595350L	Drive Shaft	48T	29	29	74	96	639
	2013.01-2018.12	6AT/8AT	F	R	Terrain cab wagon closed 4WD 306DT		2596230L	Drive Shaft	48T	29	29	74	96	998
	2016.09-	8AT	R	L	SUV 4WD 306DT		2023460L	Drive Shaft		31	31	68.2	97	838
	2016.09-	8AT	R	R	SUV 4WD 306DT		2023450L	Drive Shaft		31	31	68.2	97	860
	2020.12-	8AT	R	L	SUV 4WD AJ20D6		2023460L	Drive Shaft		31	31	68.2	97	838
	2020.12-	8AT	R	R	SUV 4WD AJ20D6		2023450L	Drive Shaft		31	31	68.2	97	860
3.0 (188 kw)	2009.09-2018.12	8AT	F	L	Terrain cab wagon closed 4WD 306DT		2595350L	Drive Shaft	48T	29	29	74	96	639
	2009.09-2018.12	8AT	F	R	Terrain cab wagon closed 4WD 306DT		2596230L	Drive Shaft	48T	29	29	74	96	998
	2011.07-2017.12	8AT	F	L	Van 4WD 306DT		2595350L	Drive Shaft	48T	29	29	74	96	639
	2011.07-2017.12	8AT	F	R	Van 4WD 306DT		2596230L	Drive Shaft	48T	29	29	74	96	998
3.0 (190 kw)	2016.09-	8AT	R	L	SUV 4WD 306DT		2023460L	Drive Shaft		31	31	68.2	97	838
	2016.09-	8AT	R	R	SUV 4WD 306DT		2023450L	Drive Shaft		31	31	68.2	97	860
	2016.09-	8AT	R	L	SUV Van 4WD 306DT		2023460L	Drive Shaft		31	31	68.2	97	838
	2016.09-	8AT	R	R	SUV Van 4WD 306DT		2023450L	Drive Shaft		31	31	68.2	97	860
	2016.09-	8AT	R	R	SUV Van 4WD 306DT		2023450L	Drive Shaft		31	31	68.2	97	860
3.0 (200 kw)	2009.09-2018.12	6AT	F	L	Terrain cab wagon closed 4WD 306DT		2595350L	Drive Shaft	48T	29	29	74	96	639
	2009.09-2018.12	6AT	F	R	Terrain cab wagon closed 4WD 306DT		2596230L	Drive Shaft	48T	29	29	74	96	998
3.0 (221 kw)	2020.12-	8AT	R	L	SUV 4WD AJ20D6		2023460L	Drive Shaft		31	31	68.2	97	838
	2020.12-	8AT	R	R	SUV 4WD AJ20D6		2023450L	Drive Shaft		31	31	68.2	97	860
	2020.12-	8AT	R	L	SUV Van 4WD AJ20D6		2023460L	Drive Shaft		31	31	68.2	97	838
	2020.12-	8AT	R	R	SUV Van 4WD AJ20D6		2023450L	Drive Shaft		31	31	68.2	97	860
3.0 (225 kw)	2018.09-	8AT	R	L	SUV 4WD 306DT		2023460L	Drive Shaft		31	31	68.2	97	838
	2018.09-	8AT	R	R	SUV 4WD 306DT		2023450L	Drive Shaft		31	31	68.2	97	860
	2018.09-	8AT	R	L	SUV Van 4WD 306DT		2023460L	Drive Shaft		31	31	68.2	97	838
	2018.09-	8AT	R	R	SUV Van 4WD 306DT		2023450L	Drive Shaft		31	31	68.2	97	860
3.0 (250 kw)	2013.08-2018.12	6AT/8AT	F	R	Terrain cab wagon closed 4WD 306PS		2596230L	Drive Shaft	48T	29	29	74	96	998
	2016.09-	8AT	R	L	SUV 4WD 306PS		2023460L	Drive Shaft		31	31	68.2	97	838
	2016.09-	8AT	R	R	SUV 4WD 306PS		2023450L	Drive Shaft		31	31	68.2	97	860
	2016.09-	8AT	R	L	SUV Van 4WD 306PS		2023460L	Drive Shaft		31	31	68.2	97	838
	2016.09-	8AT	R	R	SUV Van 4WD 306PS		2023450L	Drive Shaft		31	31	68.2	97	860
3.0 (265 kw)	2020.12-	8AT	R	L	SUV 4WD AJ20P6		2023460L	Drive Shaft		31	31	68.2	97	838
	2020.12-	8AT	R	R	SUV 4WD AJ20P6		2023450L	Drive Shaft		31	31	68.2	97	860
4.0 (160 kw)	2004.10-2009.09	AT	F	R	Terrain cab wagon closed 4WD 406PN		2596230L	Drive Shaft	48T	29	29	74	96	998
	2010.01-2018.12	AT	F	R	Terrain cab wagon closed 4WD 406PN		2596230L	Drive Shaft	48T	29	29	74	96	998
4.0 (161 kw)	2005.02-2009.09	6MT	F	R	Terrain cab wagon closed 4WD 40VSR		2596230L	Drive Shaft	48T	29	29	74	96	998
4.4 (220 kw)	2004.07-2009.08	6MT	F	R	Terrain cab wagon closed 4WD 448PN		2596230L	Drive Shaft	48T	29	29	74	96	998
5.0 (276 kw)	2009.09-2018.12	6AT	F	R	Terrain cab wagon closed 4WD 508PN		2596230L	Drive Shaft	48T	29	29	74	96	998
Discovery Sport														
2.0 (110 kw)	2014.12-	AT	F	L	SUV 4WD 204DTD		2029920L	Drive Shaft		31	31	68.3	97	590
	2014.12-	MT	F	L	SUV 4WD 204DTD		2184080L	Drive Shaft		31	31	68.3	97	602
	2015.08-	MT	F	L	SUV FWD 204DTD		2184080L	Drive Shaft		31	31	68.3	97	602
2.0 (132 kw)	2015.06-	MT	F	L	SUV 4WD 204DTD	Date From:2016.01	2184080L	Drive Shaft		31	31	68.3	97	602
2.0 (177 kw)	2017.08-	MT	F	L	SUV 4WD 204DTA	Date From:2018.01	2184080L	Drive Shaft		31	31	68.3	97	602
2.2 (110 kw)	2014.09-	MT	F	L	SUV 4WD 224DT		2184080L	Drive Shaft		31	31	68.3	97	602
2.2 (140 kw)	2014.09-	AT	F	L	SUV 4WD 224DT		2029920L	Drive Shaft		31	31	68.3	97	590





 YEAR	TRANSM.	F/R	L/R	BODY STYLE & DRIVE TYPE & ENGINE	REMARKS	GSP Ref.	 PRODUCT ABS	Technical Specifications						
								A	B	C	H	L		
LAND ROVER Discovery Sport														
2.2 (140 kw)	2014.09-	MT	F	L	SUV 4WD 224DT		2184080L	Drive Shaft		31	31	68.3	97	602
Range Rover														
2.0 (221 kw)	2017.10-	8AT	R	L	SUV 4WD PT204	Without differential lock	2023460L	Drive Shaft		31	31	68.2	97	838
	2017.10-	8AT	R	R	SUV 4WD PT204		2023450L	Drive Shaft		31	31	68.2	97	860
3.0 (155 kw)	2013.10-	8AT	R	L	SUV 4WD 306DT		2023460L	Drive Shaft		31	31	68.2	97	838
	2013.10-	8AT	R	R	SUV 4WD 306DT		2023450L	Drive Shaft		31	31	68.2	97	860
3.0 (183 kw)	2012.08-	8AT	R	L	SUV 4WD 306DT		2023460L	Drive Shaft		31	31	68.2	97	838
	2012.08-	8AT	R	R	SUV 4WD 306DT		2023450L	Drive Shaft		31	31	68.2	97	860
	2020.07-	8AT	R	L	SUV 4WD AJ20D6		2023460L	Drive Shaft		31	31	68.2	97	838
	2020.07-	8AT	R	R	SUV 4WD AJ20D6		2023450L	Drive Shaft		31	31	68.2	97	860
3.0 (190 kw)	2012.10-	8AT	R	L	SUV 4WD 306DT		2023460L	Drive Shaft		31	31	68.2	97	838
	2012.10-	8AT	R	R	SUV 4WD 306DT		2023450L	Drive Shaft		31	31	68.2	97	860
3.0 (202 kw)	2018.10-	8AT	R	L	SUV 4WD 306DT		2023460L	Drive Shaft		31	31	68.2	97	838
	2018.10-	8AT	R	R	SUV 4WD 306DT		2023450L	Drive Shaft		31	31	68.2	97	860
3.0 (215 kw)	2012.10-	8AT	R	L	SUV 4WD 306DT		2023460L	Drive Shaft		31	31	68.2	97	838
	2012.10-	8AT	R	R	SUV 4WD 306DT		2023450L	Drive Shaft		31	31	68.2	97	860
	2013.10-	8AT	R	L	SUV 4WD 306DT	Without differential lock	2023460L	Drive Shaft		31	31	68.2	97	838
	2013.10-	8AT	R	R	SUV 4WD 306DT		2023450L	Drive Shaft		31	31	68.2	97	860
3.0 (221 kw)	2020.07-	8AT	R	L	SUV 4WD AJ20D6		2023460L	Drive Shaft		31	31	68.2	97	838
	2020.07-	8AT	R	R	SUV 4WD AJ20D6		2023450L	Drive Shaft		31	31	68.2	97	860
3.0 (225 kw)	2015.06-	8AT	R	L	SUV 4WD 306DT	Without differential lock	2023460L	Drive Shaft		31	31	68.2	97	838
	2015.06-	8AT	R	R	SUV 4WD 306DT		2023450L	Drive Shaft		31	31	68.2	97	860
3.0 (250 kw)	2013.10-	8AT	R	L	SUV 4WD 306PS		2023460L	Drive Shaft		31	31	68.2	97	838
	2013.10-	8AT	R	R	SUV 4WD 306PS		2023450L	Drive Shaft		31	31	68.2	97	860
3.0 (258 kw)	2020.07-	8AT	R	L	SUV 4WD AJ20D6		2023460L	Drive Shaft		31	31	68.2	97	838
	2020.07-	8AT	R	R	SUV 4WD AJ20D6		2023450L	Drive Shaft		31	31	68.2	97	860
3.0 (265 kw)	2019.12-	8AT	R	L	SUV 4WD PT306		2023460L	Drive Shaft		31	31	68.2	97	838
	2019.12-	8AT	R	R	SUV 4WD PT306		2023450L	Drive Shaft		31	31	68.2	97	860
3.0 (280 kw)	2015.06-	8AT	R	L	SUV 4WD 306PS		2023460L	Drive Shaft		31	31	68.2	97	838
	2015.06-	8AT	R	R	SUV 4WD 306PS		2023450L	Drive Shaft		31	31	68.2	97	860
3.0 (294 kw)	2019.05-	8AT	R	L	SUV 4WD PT306	Without differential lock	2023460L	Drive Shaft		31	31	68.2	97	838
	2019.05-	8AT	R	R	SUV 4WD PT306		2023450L	Drive Shaft		31	31	68.2	97	860
	2020.07-	8AT	R	L	SUV 4WD PT306		2023460L	Drive Shaft		31	31	68.2	97	838
	2020.07-	8AT	R	R	SUV 4WD PT306		2023450L	Drive Shaft		31	31	68.2	97	860
4.4 (249 kw)	2013.08-	8AT	R	L	SUV 4WD 448DT		2023460L	Drive Shaft		31	31	68.2	97	838
	2013.08-	8AT	R	R	SUV 4WD 448DT		2023450L	Drive Shaft		31	31	68.2	97	860
4.4 (250 kw)	2012.08-	8AT	R	L	SUV 4WD 448DT		2023460L	Drive Shaft		31	31	68.2	97	838
	2012.08-	8AT	R	R	SUV 4WD 448DT		2023450L	Drive Shaft		31	31	68.2	97	860
5.0 (276 kw)	2013.12-	8AT	R	L	SUV 4WD 508PN		2023460L	Drive Shaft		31	31	68.2	97	838
	2013.12-	8AT	R	R	SUV 4WD 508PN		2023450L	Drive Shaft		31	31	68.2	97	860
5.0 (375 kw)	2012.08-	8AT	R	L	SUV 4WD 508PS		2023460L	Drive Shaft		31	31	68.2	97	838
	2012.08-	8AT	R	R	SUV 4WD 508PS		2023450L	Drive Shaft		31	31	68.2	97	860
5.0 (386 kw)	2017.11-	8AT	R	L	SUV 4WD 508PS		2023460L	Drive Shaft		31	31	68.2	97	838
	2017.11-	8AT	R	R	SUV 4WD 508PS		2023450L	Drive Shaft		31	31	68.2	97	860
5.0 (405 kw)	2015.06-	8AT	R	L	SUV 4WD 508PS	For vehicles w/o electronic ltd slip differential	2023460L	Drive Shaft		31	31	68.2	97	838
	2015.06-	8AT	R	R	SUV 4WD 508PS		2023450L	Drive Shaft		31	31	68.2	97	860
5.0 (416 kw)	2017.11-	8AT	R	L	SUV 4WD 508PS		2023460L	Drive Shaft		31	31	68.2	97	838
	2017.11-	8AT	R	R	SUV 4WD 508PS		2023450L	Drive Shaft		31	31	68.2	97	860
Range Rover Evoque														
2.0 (110 kw)	2015.06-2019.12	MT	F	L	SUV 4WD 204DTD	Date From:2016.01	2184080L	Drive Shaft		31	31	68.3	97	602
	2015.06-2019.12	MT	F	L	SUV FWD 204DTD		2184080L	Drive Shaft		31	31	68.3	97	602
	2015.11-2019.12	MT	F	L	Cabriolet 4WD 204DTD	Date From:2016.01	2184080L	Drive Shaft		31	31	68.3	97	602
2.0 (132 kw)	2015.05-2019.12	MT	F	L	SUV 4WD 204DTD		2184080L	Drive Shaft		31	31	68.3	97	602
	2015.11-2019.12	MT	F	L	Cabriolet 4WD 204DTD	Date From:2016.01	2184080L	Drive Shaft		31	31	68.3	97	602
2.0 (177 kw)	2017.08-2019.12	MT	F	L	Cabriolet 4WD 204DTA	Date From:2018.01	2184080L	Drive Shaft		31	31	68.3	97	602
	2017.08-2019.12	MT	F	L	SUV 4WD 204DTA	Date From:2018.01	2184080L	Drive Shaft		31	31	68.3	97	602
2.2 (110 kw)	2011.06-2019.12	6AT	F	L	SUV 4WD 224DT		2029920L	Drive Shaft		31	31	68.3	97	590
	2011.06-2019.12	6AT	F	R	SUV 4WD 224DT		2031770L	Drive Shaft		31	28	68.3	97	1052
	2011.06-2019.12	6MT	F	L	SUV 4WD 224DT	Chassis no. to:(V)DH999999	2184080L	Drive Shaft		31	31	68.3	97	602
	2011.06-2019.12	6MT	F	L	SUV FWD 224DT	Chassis no. to:(V)DH999999	2184080L	Drive Shaft		31	31	68.3	97	602
	2011.06-2019.12	6MT	F	R	SUV FWD 224DT	Chassis no. to:(V)DH999999	2184090L	Drive Shaft		31	28	68.3	97	1069
	2015.05-2019.12	6MT	F	L	SUV Van 4WD 224DT	Chassis no. to:(V)DH999999	2184080L	Drive Shaft		31	31	68.3	97	602
	2015.05-2019.12	6MT	F	L	SUV Van FWD 224DT	Chassis no. to:(V)DH999999	2184080L	Drive Shaft		31	31	68.3	97	602
2.2 (140 kw)	2015.05-2019.12	6MT	F	R	SUV Van FWD 224DT	Chassis no. to:(V)DH999999	2184090L	Drive Shaft		31	28	68.3	97	1069
2.2 (140 kw)	2011.06-2019.12	6AT	F	L	SUV 4WD 224DT		2029920L	Drive Shaft		31	31	68.3	97	590





  YEAR	TRANSM.	F/R	L/R	BODY STYLE & DRIVE TYPE & ENGINE	REMARKS	GSP Ref.	 PRODUCT	 ABS	Technical Specifications					
									A	B	C	H	L	
LAND ROVER														
Range Rover Evoque														
2.2 (140 kw)	2011.06-2019.12	6AT	F	R	SUV 4WD 224DT		2031770L	Drive Shaft		31	28	68.3	97	1052
	2011.06-2019.12	6MT	F	L	SUV 4WD 224DT	Chassis no. to:(V)DH999999	2184080L	Drive Shaft		31	31	68.3	97	602
	2015.05-2019.12	6MT	F	L	SUV Van 4WD 224DT	Chassis no. to:(V)DH999999	2184080L	Drive Shaft		31	31	68.3	97	602
Range Rover Sport														
2.0 (177 kw)	2016.10-	8AT	R	L	SUV 4WD 204DTA		2023460L	Drive Shaft		31	31	68.2	97	838
	2016.10-	8AT	R	R	SUV 4WD 204DTA		2023450L	Drive Shaft		31	31	68.2	97	860
2.0 (221 kw)	2017.10-	8AT	R	L	SUV 4WD PT204		2023460L	Drive Shaft		31	31	68.2	97	838
	2017.10-	8AT	R	R	SUV 4WD PT204		2023450L	Drive Shaft		31	31	68.2	97	860
2.7 (140 kw)	2005.02-2009.09	6AT	F	L	SUV 4WD 276DT		2595350L	Drive Shaft	48T	29	29	74	96	639
	2005.02-2009.09	6AT	F	R	SUV 4WD 276DT		2596230L	Drive Shaft	48T	29	29	74	96	998
3.0 (155 kw)	2010.05-2013.06	6AT/8AT	F	L	SUV 4WD 306DT		2595350L	Drive Shaft	48T	29	29	74	96	639
	2010.05-2013.06	6AT/8AT	F	R	SUV 4WD 306DT		2596230L	Drive Shaft	48T	29	29	74	96	998
	2013.07-2018.12	8AT	R	L	SUV 4WD 306DT		2023460L	Drive Shaft		31	31	68.2	97	838
	2013.07-2018.12	8AT	R	R	SUV 4WD 306DT		2023450L	Drive Shaft		31	31	68.2	97	860
3.0 (180 kw)	2009.09-2013.06	6AT	F	L	SUV 4WD 306DT		2595350L	Drive Shaft	48T	29	29	74	96	639
	2009.09-2013.06	6AT	F	R	SUV 4WD 306DT		2596230L	Drive Shaft	48T	29	29	74	96	998
3.0 (183 kw)	2010.09-2013.06	8AT	F	L	SUV 4WD 306DT		2595350L	Drive Shaft	48T	29	29	74	96	639
	2010.09-2013.06	8AT	F	R	SUV 4WD 306DT		2596230L	Drive Shaft	48T	29	29	74	96	998
	2013.07-	8AT	R	L	SUV 4WD 306DT		2023460L	Drive Shaft		31	31	68.2	97	838
	2013.07-	8AT	R	R	SUV 4WD 306DT		2023450L	Drive Shaft		31	31	68.2	97	860
	2020.07-	8AT	R	L	SUV 4WD AJ20D6		2023460L	Drive Shaft		31	31	68.2	97	838
	2020.07-	8AT	R	R	SUV 4WD AJ20D6		2023450L	Drive Shaft		31	31	68.2	97	860
3.0 (188 kw)	2011.06-2013.06	8AT	F	L	SUV 4WD 306DT		2595350L	Drive Shaft	48T	29	29	74	96	639
	2011.06-2013.06	8AT	F	R	SUV 4WD 306DT		2596230L	Drive Shaft	48T	29	29	74	96	998
3.0 (190 kw)	2013.07-2019.12	8AT	R	L	SUV 4WD 306DT		2023460L	Drive Shaft		31	31	68.2	97	838
	2013.07-2019.12	8AT	R	R	SUV 4WD 306DT		2023450L	Drive Shaft		31	31	68.2	97	860
3.0 (215 kw)	2013.07-2016.12	8AT	R	L	SUV 4WD 306DT		2023460L	Drive Shaft		31	31	68.2	97	838
	2013.07-2016.12	8AT	R	R	SUV 4WD 306DT		2023450L	Drive Shaft		31	31	68.2	97	860
	2013.10-2017.12	8AT	R	L	SUV 4WD 306DT		2023460L	Drive Shaft		31	31	68.2	97	838
	2013.10-2017.12	8AT	R	R	SUV 4WD 306DT		2023450L	Drive Shaft		31	31	68.2	97	860
3.0 (221 kw)	2020.07-	8AT	R	L	SUV 4WD AJ20D6		2023460L	Drive Shaft		31	31	68.2	97	838
	2020.07-	8AT	R	R	SUV 4WD AJ20D6		2023450L	Drive Shaft		31	31	68.2	97	860
3.0 (225 kw)	2014.09-	8AT	R	L	SUV 4WD 306DT		2023460L	Drive Shaft		31	31	68.2	97	838
	2014.09-	8AT	R	R	SUV 4WD 306DT		2023450L	Drive Shaft		31	31	68.2	97	860
	2015.06-2017.12	8AT	R	L	SUV 4WD 306DT		2023460L	Drive Shaft		31	31	68.2	97	838
	2015.06-2017.12	8AT	R	R	SUV 4WD 306DT		2023450L	Drive Shaft		31	31	68.2	97	860
3.0 (250 kw)	2013.07-2019.12	8AT	R	L	SUV 4WD 306PS		2023460L	Drive Shaft		31	31	68.2	97	838
	2013.07-2019.12	8AT	R	R	SUV 4WD 306PS		2023450L	Drive Shaft		31	31	68.2	97	860
3.0 (258 kw)	2020.07-	8AT	R	L	SUV 4WD AJ20D6		2023460L	Drive Shaft		31	31	68.2	97	838
	2020.07-	8AT	R	R	SUV 4WD AJ20D6		2023450L	Drive Shaft		31	31	68.2	97	860
3.0 (265 kw)	2019.06-	8AT	R	L	SUV 4WD PT306		2023460L	Drive Shaft		31	31	68.2	97	838
	2019.06-	8AT	R	R	SUV 4WD PT306		2023450L	Drive Shaft		31	31	68.2	97	860
3.0 (280 kw)	2015.06-2019.12	8AT	R	L	SUV 4WD 306PS		2023460L	Drive Shaft		31	31	68.2	97	838
	2015.06-2019.12	8AT	R	R	SUV 4WD 306PS		2023450L	Drive Shaft		31	31	68.2	97	860
3.0 (294 kw)	2019.02-	8AT	R	L	SUV 4WD AJ20P6		2023460L	Drive Shaft		31	31	68.2	97	838
	2019.02-	8AT	R	R	SUV 4WD AJ20P6		2023450L	Drive Shaft		31	31	68.2	97	860
3.6 (200 kw)	2006.04-2012.12	6AT/8AT	F	R	SUV 4WD 36DDEX		2596230L	Drive Shaft	48T	29	29	74	96	998
4.2 (287 kw)	2005.02-2013.06	6AT	F	R	SUV 4WD 428PS		2596230L	Drive Shaft	48T	29	29	74	96	998
4.2 (291 kw)	2006.01-2010.02	6AT	F	R	SUV 4WD 428PS		2596230L	Drive Shaft	48T	29	29	74	96	998
4.4 (220 kw)	2005.02-2013.12	6AT	F	R	SUV 4WD 448PN		2596230L	Drive Shaft	48T	29	29	74	96	998
4.4 (250 kw)	2013.10-	8AT	R	L	SUV 4WD 44DD0R		2023460L	Drive Shaft		31	31	68.2	97	838
	2013.10-	8AT	R	R	SUV 4WD 44DD0R		2023450L	Drive Shaft		31	31	68.2	97	860
5.0 (276 kw)	2009.07-2013.06	6AT	F	R	SUV 4WD 508PN		2596230L	Drive Shaft	48T	29	29	74	96	998
5.0 (372 kw)	2010.01-2013.06	6AT	F	R	SUV 4WD 508PS		2596230L	Drive Shaft	48T	29	29	74	96	998
5.0 (375 kw)	2009.09-2013.06	6AT	F	R	SUV 4WD 508PS		2596230L	Drive Shaft	48T	29	29	74	96	998
	2013.07-2018.12	8AT	R	L	SUV 4WD 508PS		2023460L	Drive Shaft		31	31	68.2	97	838
	2013.07-2018.12	8AT	R	R	SUV 4WD 508PS		2023450L	Drive Shaft		31	31	68.2	97	860
5.0 (386 kw)	2017.11-	8AT	R	L	SUV 4WD 508PS		2023460L	Drive Shaft		31	31	68.2	97	838
	2017.11-	8AT	R	R	SUV 4WD 508PS		2023450L	Drive Shaft		31	31	68.2	97	860
5.0 (405 kw)	2014.01-2018.12	8AT	R	L	SUV 4WD 508PS		2023460L	Drive Shaft		31	31	68.2	97	838
	2014.01-2018.12	8AT	R	R	SUV 4WD 508PS		2023450L	Drive Shaft		31	31	68.2	97	860
5.0 (423 kw)	2017.11-	8AT	R	L	SUV 4WD 508PS		2023460L	Drive Shaft		31	31	68.2	97	838
	2017.11-	8AT	R	R	SUV 4WD 508PS		2023450L	Drive Shaft		31	31	68.2	97	860





  YEAR	TRANSM.	F/R	L/R	BODY STYLE & DRIVE TYPE & ENGINE	REMARKS	GSP Ref.	 PRODUCT	 ABS	Technical Specifications					
									A	B	C	H	L	
LEXUS														
ES 350														
3.5 (183 kw)	2014.01-2018.06	6AT	F	L	Saloon FWD 2GRFE		2593240L	Drive Shaft	48T	30	24		100	659
	2014.01-2018.06	6AT	F	R	Saloon FWD 2GRFE		2593230L	Drive Shaft	48T	30	24		100	978
3.5 (204 kw)	2006.06-2012.06	6AT	F	L	Saloon FWD 2GRFE		2593240L	Drive Shaft	48T	30	24		100	659
	2006.06-2012.06	6AT	F	R	Saloon FWD 2GRFE		2593230L	Drive Shaft	48T	30	24		100	978
	2012.06-2018.06	6AT	F	L	Saloon FWD 2GRFE		2593240L	Drive Shaft	48T	30	24		100	659
	2012.06-2018.06	6AT	F	R	Saloon FWD 2GRFE		2593230L	Drive Shaft	48T	30	24		100	978
GX 460														
4.6 (218 kw)	2010.01-	6AT	F	L/R	SUV 4WD 1URFE		2590150L	Drive Shaft		30	30	70	101.5	648
4.6 (225 kw)	2010.01-	6AT	F	L/R	SUV 4WD 1URFE		2590150L	Drive Shaft		30	30	70	101.5	648
GX 470														
4.7 (175 kw)	2001.11-2009.11	5AT	F	L/R	SUV 4WD 2UZFE		2590150L	Drive Shaft		30	30	70	101.5	648
4.7 (199 kw)	2001.11-2009.11	5AT	F	L/R	SUV 4WD 2UZFE		2590150L	Drive Shaft		30	30	70	101.5	648
MAN														
TGE 2.140														
2.0 (103 kw)	2016.11-	6MT	F	L	Platform/Chassis FWD DAUA	Date from:2017.04,Model code:U*	2039380L	Drive Shaft		44	42	72.4	109.5	722
	2016.11-	6MT	F	R	Platform/Chassis FWD DAUA	Date from:2017.04,Model code:U*	2039350L	Drive Shaft		44	42	72.4	109.5	1089
	2016.11-	8AT	F	L	Platform/Chassis FWD DAUA	Model code:U*	2039370L	Drive Shaft		44	42	72.4	109.5	707
	2016.11-	8AT	F	R	Platform/Chassis FWD DAUA	Model code:U*	2039350L	Drive Shaft		44	42	72.4	109.5	1089
	2017.02-	6MT	F	L	Van FWD DAUA	Date from:2017.04,Model code:U*	2039380L	Drive Shaft		44	42	72.4	109.5	722
	2017.02-	6MT	F	R	Van FWD DAUA	Date from:2017.04,Model code:U*	2039350L	Drive Shaft		44	42	72.4	109.5	1089
	2017.02-	8AT	F	L	Van FWD DAUA	Model code:U*	2039370L	Drive Shaft		44	42	72.4	109.5	707
	2017.02-	8AT	F	R	Van FWD DAUA	Model code:U*	2039350L	Drive Shaft		44	42	72.4	109.5	1089
	2017.04-	6MT	F	L	Van 4WD DAUA	Model code:U*	2039380L	Drive Shaft		44	42	72.4	109.5	722
	2017.04-	6MT	F	R	Van 4WD DAUA	Model code:U*	2039360L	Drive Shaft		44	26	72.4	109.5	687
	2017.05-	6MT	F	L	Platform/Chassis 4WD DAUA	Model code:U*	2039380L	Drive Shaft		44	42	72.4	109.5	722
	2017.05-	6MT	F	R	Platform/Chassis 4WD DAUA	Model code:U*	2039360L	Drive Shaft		44	26	72.4	109.5	687
TGE 2.180														
2.0 (130 kw)	2016.11-	6MT	F	L	Platform/Chassis FWD DAVA	Date from:2017.04,Model code:U*	2039380L	Drive Shaft		44	42	72.4	109.5	722
	2016.11-	6MT	F	R	Platform/Chassis FWD DAVA	Date from:2017.04,Model code:U*	2039350L	Drive Shaft		44	42	72.4	109.5	1089
	2016.11-	8AT	F	L	Platform/Chassis FWD DAVA	Model code:U*	2039370L	Drive Shaft		44	42	72.4	109.5	707
	2016.11-	8AT	F	R	Platform/Chassis FWD DAVA	Model code:U*	2039350L	Drive Shaft		44	42	72.4	109.5	1089
	2017.02-	6MT	F	L	Van FWD DAVA	Date from:2017.04,Model code:U*	2039380L	Drive Shaft		44	42	72.4	109.5	722
	2017.02-	6MT	F	R	Van FWD DAVA	Date from:2017.04,Model code:U*	2039350L	Drive Shaft		44	42	72.4	109.5	1089
	2017.02-	8AT	F	L	Van FWD DAVA	Model code:U*	2039370L	Drive Shaft		44	42	72.4	109.5	707
	2017.02-	8AT	F	R	Van FWD DAVA	Model code:U*	2039350L	Drive Shaft		44	42	72.4	109.5	1089
	2017.03-	8AT/6MT	F	L	Van 4WD DAVA	Date from:2017.04,Model code:U*	2039380L	Drive Shaft		44	42	72.4	109.5	722
	2017.03-	8AT/6MT	F	R	Van 4WD DAVA	Date from:2017.04,Model code:U*	2039360L	Drive Shaft		44	26	72.4	109.5	687
	2017.05-	8AT/6MT	F	L	Platform/Chassis 4WD DAVA	Model code:U*	2039380L	Drive Shaft		44	42	72.4	109.5	722
	2017.05-	8AT/6MT	F	R	Platform/Chassis 4WD DAVA	Model code:U*	2039360L	Drive Shaft		44	26	72.4	109.5	687
	TGE 3.140													
	2.0 (103 kw)	2017.02-	6MT	F	L	Bus FWD DAUA	Date from:2017.04,Model code:U*	2039380L	Drive Shaft		44	42	72.4	109.5
2017.02-		6MT	F	R	Bus FWD DAUA	Date from:2017.04,Model code:U*	2039350L	Drive Shaft		44	42	72.4	109.5	1089
2017.02-		8AT	F	L	Bus FWD DAUA	Model code:U*	2039370L	Drive Shaft		44	42	72.4	109.5	707
2017.02-		8AT	F	R	Bus FWD DAUA	Model code:U*	2039350L	Drive Shaft		44	42	72.4	109.5	1089
2017.02-		6MT	F	L	Platform/Chassis FWD DAUA	Date from:2017.04,Model code:U*	2039380L	Drive Shaft		44	42	72.4	109.5	722
2017.02-		6MT	F	R	Platform/Chassis FWD DAUA	Date from:2017.04,Model code:U*	2039350L	Drive Shaft		44	42	72.4	109.5	1089
2017.02-		8AT	F	L	Platform/Chassis FWD DAUA	Model code:U*	2039370L	Drive Shaft		44	42	72.4	109.5	707
2017.02-		8AT	F	R	Platform/Chassis FWD DAUA	Model code:U*	2039350L	Drive Shaft		44	42	72.4	109.5	1089
2017.02-		6MT	F	L	Van FWD DAUA	Date from:2017.04,Model code:U*	2039380L	Drive Shaft		44	42	72.4	109.5	722
2017.02-		6MT	F	R	Van FWD DAUA	Date from:2017.04,Model code:U*	2039350L	Drive Shaft		44	42	72.4	109.5	1089
2017.02-		8AT	F	L	Van FWD DAUA	Model code:U*	2039370L	Drive Shaft		44	42	72.4	109.5	707
2017.02-		8AT	F	R	Van FWD DAUA	Model code:U*	2039350L	Drive Shaft		44	42	72.4	109.5	1089
2017.04-		6MT	F	L	Bus 4WD DAUA	Model code:U*	2039380L	Drive Shaft		44	42	72.4	109.5	722
2017.04-		6MT	F	R	Bus 4WD DAUA	Model code:U*	2039360L	Drive Shaft		44	26	72.4	109.5	687
2017.04-		6MT	F	L	Van 4WD DAUA	Model code:U*	2039380L	Drive Shaft		44	42	72.4	109.5	722
2017.04-		6MT	F	R	Van 4WD DAUA	Model code:U*	2039360L	Drive Shaft		44	26	72.4	109.5	687
2017.05-		6MT	F	L	Platform/Chassis 4WD DAUA	Model code:U*	2039380L	Drive Shaft		44	42	72.4	109.5	722
2017.05-		6MT	F	R	Platform/Chassis 4WD DAUA	Model code:U*	2039360L	Drive Shaft		44	26	72.4	109.5	687
TGE 3.180														
2.0 (130 kw)		2017.02-	6MT	F	L	Bus FWD DAVA	Date from:2017.04,Model code:U*	2039380L	Drive Shaft		44	42	72.4	109.5
	2017.02-	6MT	F	R	Bus FWD DAVA	Date from:2017.04,Model code:U*	2039350L	Drive Shaft		44	42	72.4	109.5	1089
	2017.02-	8AT	F	L	Bus FWD DAVA	Model code:U*	2039370L	Drive Shaft		44	42	72.4	109.5	707
	2017.02-	8AT	F	R	Bus FWD DAVA	Model code:U*	2039350L	Drive Shaft		44	42	72.4	109.5	1089
	2017.02-	6MT	F	L	Platform/Chassis FWD DAVA	Date from:2017.04,Model code:U*	2039380L	Drive Shaft		44	42	72.4	109.5	722
	2017.02-	6MT	F	R	Platform/Chassis FWD DAVA	Date from:2017.04,Model code:U*	2039350L	Drive Shaft		44	42	72.4	109.5	1089



  YEAR	TRANSM.	F/R	L/R	BODY STYLE & DRIVE TYPE & ENGINE	REMARKS	GSP Ref.	 PRODUCT	 ABS	Technical Specifications				
									A	B	C	H	L
MAN													
TGE 3.180													
2.0 (130 kw)	2017.02-	8AT	F	L	Platform/Chassis FWD DAVA	Model code:U*	2039370L	Drive Shaft	44	42	72.4	109.5	707
	2017.02-	8AT	F	R	Platform/Chassis FWD DAVA	Model code:U*	2039350L	Drive Shaft	44	42	72.4	109.5	1089
	2017.02-	6MT	F	L	Van FWD DAVA	Date from:2017.04,Model code:U*	2039380L	Drive Shaft	44	42	72.4	109.5	722
	2017.02-	6MT	F	R	Van FWD DAVA	Date from:2017.04,Model code:U*	2039350L	Drive Shaft	44	42	72.4	109.5	1089
	2017.02-	8AT	F	L	Van FWD DAVA	Model code:U*	2039370L	Drive Shaft	44	42	72.4	109.5	707
	2017.02-	8AT	F	R	Van FWD DAVA	Model code:U*	2039350L	Drive Shaft	44	42	72.4	109.5	1089
	2017.03-	8AT/6MT	F	L	Bus 4WD DAVA	Date from:2017.04,Model code:U*	2039380L	Drive Shaft	44	42	72.4	109.5	722
	2017.03-	8AT/6MT	F	R	Bus 4WD DAVA	Date from:2017.04,Model code:U*	2039360L	Drive Shaft	44	26	72.4	109.5	687
	2017.03-	8AT/6MT	F	L	Van 4WD DAVA	Date from:2017.04,Model code:U*	2039380L	Drive Shaft	44	42	72.4	109.5	722
	2017.03-	8AT/6MT	F	R	Van 4WD DAVA	Date from:2017.04,Model code:U*	2039360L	Drive Shaft	44	26	72.4	109.5	687
	2017.11-	8AT/6MT	F	L	Platform/Chassis 4WD DAVA	Model code:U*	2039380L	Drive Shaft	44	42	72.4	109.5	722
	2017.11-	8AT/6MT	F	R	Platform/Chassis 4WD DAVA	Model code:U*	2039360L	Drive Shaft	44	26	72.4	109.5	687
TGE 4.140													
2.0 (103 kw)	2017.02-	6MT	F	L	Bus FWD DAUA	Date from:2017.04,Model code:U*	2039380L	Drive Shaft	44	42	72.4	109.5	722
	2017.02-	6MT	F	R	Bus FWD DAUA	Date from:2017.04,Model code:U*	2039350L	Drive Shaft	44	42	72.4	109.5	1089
	2017.02-	8AT	F	L	Bus FWD DAUA	Model code:U*	2039370L	Drive Shaft	44	42	72.4	109.5	707
	2017.02-	8AT	F	R	Bus FWD DAUA	Model code:U*	2039350L	Drive Shaft	44	42	72.4	109.5	1089
	2017.02-	6MT	F	L	Platform/Chassis FWD DAUA	Date from:2017.04,Model code:U*	2039380L	Drive Shaft	44	42	72.4	109.5	722
	2017.02-	6MT	F	R	Platform/Chassis FWD DAUA	Date from:2017.04,Model code:U*	2039350L	Drive Shaft	44	42	72.4	109.5	1089
	2017.02-	8AT	F	L	Platform/Chassis FWD DAUA	Model code:U*	2039370L	Drive Shaft	44	42	72.4	109.5	707
	2017.02-	8AT	F	R	Platform/Chassis FWD DAUA	Model code:U*	2039350L	Drive Shaft	44	42	72.4	109.5	1089
	2017.02-	6MT	F	L	Van FWD DAUA	Date from:2017.04,Model code:U*	2039380L	Drive Shaft	44	42	72.4	109.5	722
	2017.02-	6MT	F	R	Van FWD DAUA	Date from:2017.04,Model code:U*	2039350L	Drive Shaft	44	42	72.4	109.5	1089
	2017.02-	8AT	F	L	Van FWD DAUA	Model code:U*	2039370L	Drive Shaft	44	42	72.4	109.5	707
	2017.02-	8AT	F	R	Van FWD DAUA	Model code:U*	2039350L	Drive Shaft	44	42	72.4	109.5	1089
	2017.04-	6MT	F	L	Bus 4WD DAUA	Model code:U*	2039380L	Drive Shaft	44	42	72.4	109.5	722
	2017.04-	6MT	F	R	Bus 4WD DAUA	Model code:U*	2039360L	Drive Shaft	44	26	72.4	109.5	687
	2017.04-	6MT	F	L	Van 4WD DAUA	Model code:U*	2039380L	Drive Shaft	44	42	72.4	109.5	722
	2017.04-	6MT	F	R	Van 4WD DAUA	Model code:U*	2039360L	Drive Shaft	44	26	72.4	109.5	687
	2017.05-	6MT	F	L	Platform/Chassis 4WD DAUA	Model code:U*	2039380L	Drive Shaft	44	42	72.4	109.5	722
	2017.05-	6MT	F	R	Platform/Chassis 4WD DAUA	Model code:U*	2039360L	Drive Shaft	44	26	72.4	109.5	687
TGE 4.180													
2.0 (130 kw)	2017.02-	6MT	F	L	Bus FWD DAVA	Date from:2017.04,Model code:U*	2039380L	Drive Shaft	44	42	72.4	109.5	722
	2017.02-	6MT	F	R	Bus FWD DAVA	Date from:2017.04,Model code:U*	2039350L	Drive Shaft	44	42	72.4	109.5	1089
	2017.02-	8AT	F	L	Bus FWD DAVA	Model code:U*	2039370L	Drive Shaft	44	42	72.4	109.5	707
	2017.02-	8AT	F	R	Bus FWD DAVA	Model code:U*	2039350L	Drive Shaft	44	42	72.4	109.5	1089
	2017.02-	6MT	F	L	Platform/Chassis FWD DAVA	Date from:2017.04,Model code:U*	2039380L	Drive Shaft	44	42	72.4	109.5	722
	2017.02-	6MT	F	R	Platform/Chassis FWD DAVA	Date from:2017.04,Model code:U*	2039350L	Drive Shaft	44	42	72.4	109.5	1089
	2017.02-	8AT	F	L	Platform/Chassis FWD DAVA	Model code:U*	2039370L	Drive Shaft	44	42	72.4	109.5	707
	2017.02-	8AT	F	R	Platform/Chassis FWD DAVA	Model code:U*	2039350L	Drive Shaft	44	42	72.4	109.5	1089
	2017.02-	6MT	F	L	Van FWD DAVA	Date from:2017.04,Model code:U*	2039380L	Drive Shaft	44	42	72.4	109.5	722
	2017.02-	6MT	F	R	Van FWD DAVA	Date from:2017.04,Model code:U*	2039350L	Drive Shaft	44	42	72.4	109.5	1089
	2017.02-	8AT	F	L	Van FWD DAVA	Model code:U*	2039370L	Drive Shaft	44	42	72.4	109.5	707
	2017.02-	8AT	F	R	Van FWD DAVA	Model code:U*	2039350L	Drive Shaft	44	42	72.4	109.5	1089
	2017.03-	8AT/6MT	F	L	Bus 4WD DAVA	Date from:2017.04,Model code:U*	2039380L	Drive Shaft	44	42	72.4	109.5	722
	2017.03-	8AT/6MT	F	R	Bus 4WD DAVA	Date from:2017.04,Model code:U*	2039360L	Drive Shaft	44	26	72.4	109.5	687
	2017.03-	8AT/6MT	F	L	Van 4WD DAVA	Date from:2017.04,Model code:U*	2039380L	Drive Shaft	44	42	72.4	109.5	722
	2017.03-	8AT/6MT	F	R	Van 4WD DAVA	Date from:2017.04,Model code:U*	2039360L	Drive Shaft	44	26	72.4	109.5	687
	2017.11-	8AT/6MT	F	L	Platform/Chassis 4WD DAVA	Model code:U*	2039380L	Drive Shaft	44	42	72.4	109.5	722
	2017.11-	8AT/6MT	F	R	Platform/Chassis 4WD DAVA	Model code:U*	2039360L	Drive Shaft	44	26	72.4	109.5	687
MERCEDES-BENZ													
A160													
1.5 (66 kw)	2013.06-2018.05	MT	F	L	Hatchback FWD 607951		2350670L	Drive Shaft	30	27	65.5	53.5	537
1.5 (70 kw)	2019.05-	6MT	F	L	Hatchback FWD 608915		2039800L	Drive Shaft	30	27	65	53	543
	2019.05-	6MT	F	R	Hatchback FWD 608915		2039790L	Drive Shaft	30	27	65	53	509
	2019.10-	6MT	F	L	Saloon FWD 608915		2039800L	Drive Shaft	30	27	65	53	543
	2019.10-	6MT	F	R	Saloon FWD 608915		2039790L	Drive Shaft	30	27	65	53	509
A180													
1.5 (80 kw)	2012.06-2018.05	7AT/6MT	F	L	Hatchback FWD 607951		2350670L	Drive Shaft	30	27	65.5	53.5	537
1.5 (85 kw)	2018.03-	6MT	F	L	Hatchback FWD 608915		2039800L	Drive Shaft	30	27	65	53	543
	2018.03-	6MT	F	R	Hatchback FWD 608915		2039790L	Drive Shaft	30	27	65	53	509
	2018.03-	7DCT	F	L	Hatchback FWD 608915		2036820L	Drive Shaft	30	27	65	53	576
	2018.03-	7DCT	F	R	Hatchback FWD 608915		2036850L	Drive Shaft	30	27	65	53	501
	2018.09-	6MT	F	L	Saloon FWD 608915		2039800L	Drive Shaft	30	27	65	53	543
	2018.09-	6MT	F	R	Saloon FWD 608915		2039790L	Drive Shaft	30	27	65	53	509



		TRANSM.	F/R	L/R	BODY STYLE & DRIVE TYPE & ENGINE	REMARKS	GSP Ref.		Technical Specifications				
									A	B	C	H	L
MERCEDES-BENZ A180													
1.5 (85 kw)	2018.09-	7DCT	F	L	Saloon FWD 608915		2036820L	Drive Shaft	30	27	65	53	576
	2018.09-	7DCT	F	R	Saloon FWD 608915		2036850L	Drive Shaft	30	27	65	53	501
1.6 (90 kw)	2012.09-2018.05	7AT/6MT	F	L	Hatchback FWD 270910		2350670L	Drive Shaft	30	27	65.5	53.5	537
1.8 (80 kw)	2012.06-2014.10	7AT/6MT	F	L	Hatchback FWD 651901		2350670L	Drive Shaft	30	27	65.5	53.5	537
	2012.06-2014.10	7AT/6MT	F	R	Hatchback FWD 651901	With Intermediate Shaft	2014700L	Drive Shaft	30	27	65.5	53.5	998
2.0 (85 kw)	2020.10-	6MT	F	L	Hatchback FWD 654920		2039800L	Drive Shaft	30	27	65	53	543
	2020.10-	6MT	F	R	Hatchback FWD 654920		2039790L	Drive Shaft	30	27	65	53	509
	2020.10-	8DCT	F	R	Hatchback FWD 654920		2036850L	Drive Shaft	30	27	65	53	501
	2020.10-	6MT	F	L	Saloon FWD 654920		2039800L	Drive Shaft	30	27	65	53	543
	2020.10-	6MT	F	R	Saloon FWD 654920		2039790L	Drive Shaft	30	27	65	53	509
	2020.10-	8DCT	F	R	Saloon FWD 654920	Date To:2021.02	2036850L	Drive Shaft	30	27	65	53	501
A200													
1.6 (115 kw)	2012.06-2018.05	7AT/6MT	F	L	Hatchback FWD 270910		2350670L	Drive Shaft	30	27	65.5	53.5	537
1.8 (100 kw)	2012.06-2014.10	7AT/6MT	F	L	Hatchback FWD 651901		2350670L	Drive Shaft	30	27	65.5	53.5	537
	2012.06-2014.10	7AT/6MT	F	R	Hatchback FWD 651901	With Intermediate Shaft	2014700L	Drive Shaft	30	27	65.5	53.5	998
2.0 (110 kw)	2018.11-	6MT	F	L	Hatchback FWD 654920		2039800L	Drive Shaft	30	27	65	53	543
	2018.11-	6MT	F	R	Hatchback FWD 654920		2039790L	Drive Shaft	30	27	65	53	509
	2018.11-	8DCT	F	R	Hatchback FWD 654920		2036850L	Drive Shaft	30	27	65	53	501
	2019.08-	8DCT	F	R	Saloon FWD 654920		2036850L	Drive Shaft	30	27	65	53	501
	2019.10-	8DCT	F	R	Hatchback 4WD 654920		2036850L	Drive Shaft	30	27	65	53	501
	2019.10-	8DCT	F	R	Saloon 4WD 654920		2036850L	Drive Shaft	30	27	65	53	501
2.2 (100 kw)	2014.02-2018.05	AT	F	L	Hatchback 4WD 651930		2350670L	Drive Shaft	30	27	65.5	53.5	537
	2014.02-2018.05	AT	F	R	Hatchback 4WD 651930	With Intermediate Shaft	2014700L	Drive Shaft	30	27	65.5	53.5	998
	2014.02-2018.05	AT	F	L	Hatchback FWD 651930		2350670L	Drive Shaft	30	27	65.5	53.5	537
	2014.02-2018.05	AT	F	R	Hatchback FWD 651930	With Intermediate Shaft	2014700L	Drive Shaft	30	27	65.5	53.5	998
A220													
2.0 (135 kw)	2014.05-2018.05	AT	F	L	Hatchback 4WD 270920		2350670L	Drive Shaft	30	27	65.5	53.5	537
2.2 (120 kw)	2014.01-2018.05	AT	F	L	Hatchback FWD 651930		2350670L	Drive Shaft	30	27	65.5	53.5	537
	2014.01-2018.05	AT	F	R	Hatchback FWD 651930	With Intermediate Shaft	2014700L	Drive Shaft	30	27	65.5	53.5	998
2.2 (125 kw)	2012.06-2018.05	7AT/6MT	F	L	Hatchback FWD 651930		2350670L	Drive Shaft	30	27	65.5	53.5	537
	2014.02-2018.05	AT	F	L	Hatchback 4WD 651930		2350670L	Drive Shaft	30	27	65.5	53.5	537
	2014.02-2018.05	AT	F	R	Hatchback 4WD 651930	With Intermediate Shaft	2014700L	Drive Shaft	30	27	65.5	53.5	998
2.2 (130 kw)	2015.07-2018.05	DCT	F	L	Hatchback 4WD 651930		2350670L	Drive Shaft	30	27	65.5	53.5	537
	2015.07-2018.05	DCT	F	R	Hatchback 4WD 651930	With Intermediate Shaft	2014700L	Drive Shaft	30	27	65.5	53.5	998
	2015.07-2018.05	DCT	F	L	Hatchback FWD 651930		2350670L	Drive Shaft	30	27	65.5	53.5	537
	2015.07-2018.05	DCT	F	R	Hatchback FWD 651930	With Intermediate Shaft	2014700L	Drive Shaft	30	27	65.5	53.5	998
A250													
2.0 (155 kw)	2012.06-2018.05	7AT/6MT	F	L	Hatchback FWD 270920		2350670L	Drive Shaft	30	27	65.5	53.5	537
	2013.06-2018.05	AT	F	L	Hatchback 4WD 270920		2350670L	Drive Shaft	30	27	65.5	53.5	537
2.0 (160 kw)	2015.07-2018.05	DCT	F	L	Hatchback 4WD 270920		2350670L	Drive Shaft	30	27	65.5	53.5	537
	2015.07-2018.05	MT/DCT	F	L	Hatchback FWD 270920		2350670L	Drive Shaft	30	27	65.5	53.5	537
A45 AMG													
2.0 (280 kw)	2015.07-2018.05	7AT	F	L	Hatchback 4WD 133980		2350670L	Drive Shaft	30	27	65.5	53.5	537
	2015.07-2018.05	7AT	F	R	Hatchback 4WD 133980		2014700L	Drive Shaft	30	27	65.5	53.5	998
B160													
1.5 (66 kw)	2013.05-2018.12	AT/MT	F	L	Hatchback FWD 607951		2350670L	Drive Shaft	30	27	65.5	53.5	537
1.5 (70 kw)	2019.05-	6MT	F	L	Hatchback FWD 608915		2039800L	Drive Shaft	30	27	65	53	543
	2019.05-	6MT	F	R	Hatchback FWD 608915		2039790L	Drive Shaft	30	27	65	53	509
	2019.05-	7DCT	F	L	Hatchback FWD 608915		2036820L	Drive Shaft	30	27	65	53	576
	2019.05-	7DCT	F	R	Hatchback FWD 608915		2036850L	Drive Shaft	30	27	65	53	501
	2019.05-	7DCT	F	R	Hatchback FWD 608915		2036850L	Drive Shaft	30	27	65	53	501
1.6 (75 kw)	2015.07-2018.12	MT/DCT	F	L	Hatchback FWD 270910		2350670L	Drive Shaft	30	27	65.5	53.5	537
B180													
1.5 (80 kw)	2013.02-2018.12	AT/MT	F	L	Hatchback FWD 607951		2350670L	Drive Shaft	30	27	65.5	53.5	537
1.5 (85 kw)	2018.12-	6MT	F	L	Hatchback FWD 608915		2039800L	Drive Shaft	30	27	65	53	543
	2018.12-	6MT	F	R	Hatchback FWD 608915		2039790L	Drive Shaft	30	27	65	53	509
	2018.12-	7DCT	F	L	Hatchback FWD 608915		2036820L	Drive Shaft	30	27	65	53	576
	2018.12-	7DCT	F	R	Hatchback FWD 608915		2036850L	Drive Shaft	30	27	65	53	501
1.6 (90 kw)	2011.11-2018.12	AT/MT	F	L	Hatchback FWD 270910		2350670L	Drive Shaft	30	27	65.5	53.5	537
1.8 (80 kw)	2011.11-2014.08	AT/MT	F	L	Hatchback FWD 651901		2350670L	Drive Shaft	30	27	65.5	53.5	537
	2011.11-2014.08	AT/MT	F	R	Hatchback FWD 651901	With Intermediate Shaft	2014700L	Drive Shaft	30	27	65.5	53.5	998
2.0 (85 kw)	2020.10-	6MT	F	L	Hatchback FWD 654920		2039800L	Drive Shaft	30	27	65	53	543
	2020.10-	6MT	F	R	Hatchback FWD 654920		2039790L	Drive Shaft	30	27	65	53	509
	2020.10-	8DCT	F	R	Hatchback FWD 654920		2036850L	Drive Shaft	30	27	65	53	501
2.2 (80 kw)	2013.06-2014.08	7AT/6MT	F	R	Hatchback FWD 651930	With Intermediate Shaft	2014700L	Drive Shaft	30	27	65.5	53.5	998



	 YEAR	TRANSM.	F/R	L/R	BODY STYLE & DRIVE TYPE & ENGINE	REMARKS	GSP Ref.	 PRODUCT	 ABS	Technical Specifications				
										A	B	C	H	L
MERCEDES-BENZ B200														
1.6 (115 kw)	2011.11-2018.12	AT/MT	F	L	Hatchback FWD 270910		2350670L	Drive Shaft		30	27	65.5	53.5	537
1.8 (100 kw)	2011.11-2014.08	AT/MT	F	L	Hatchback FWD 651901		2350670L	Drive Shaft		30	27	65.5	53.5	537
	2011.11-2014.08	AT/MT	F	R	Hatchback FWD 651901	With Intermediate Shaft	2014700L	Drive Shaft		30	27	65.5	53.5	998
2.0 (110 kw)	2018.12-	6MT	F	L	Hatchback FWD 654920		2039800L	Drive Shaft		30	27	65	53	543
	2018.12-	6MT	F	R	Hatchback FWD 654920		2039790L	Drive Shaft		30	27	65	53	509
	2018.12-	8DCT	F	R	Hatchback FWD 654920	Date To:2021.02	2036850L	Drive Shaft		30	27	65	53	501
	2019.10-	8DCT	F	R	Hatchback 4WD 654920		2036850L	Drive Shaft		30	27	65	53	501
2.0 (115 kw)	2012.11-2017.12	AT/MT	F	L	Hatchback FWD 270920NGT		2350670L	Drive Shaft		30	27	65.5	53.5	537
2.2 (100 kw)	2014.08-2018.12	AT/MT	F	L	Hatchback 4WD 651930		2350670L	Drive Shaft		30	27	65.5	53.5	537
	2014.08-2018.12	AT/MT	F	R	Hatchback 4WD 651930	With Intermediate Shaft	2014700L	Drive Shaft		30	27	65.5	53.5	998
	2014.08-2018.12	AT/MT	F	L	Hatchback FWD 651930		2350670L	Drive Shaft		30	27	65.5	53.5	537
	2014.08-2018.12	AT/MT	F	R	Hatchback FWD 651930	With Intermediate Shaft	2014700L	Drive Shaft		30	27	65.5	53.5	998
B220														
2.0 (135 kw)	2013.05-2018.12	AT/MT	F	L	Hatchback 4WD 270920		2350670L	Drive Shaft		30	27	65.5	53.5	537
2.2 (120 kw)	2013.06-2018.12	AT/MT	F	L/R	Hatchback FWD 651930		2350670L	Drive Shaft		30	27	65.5	53.5	537
2.2 (125 kw)	2011.11-2018.12	AT/MT	F	L/R	Hatchback FWD 651930		2350670L	Drive Shaft		30	27	65.5	53.5	537
	2018.06-2018.12	7AT/6MT	F	L	Hatchback 4WD 651930		2350670L	Drive Shaft		30	27	65.5	53.5	537
	2018.06-2018.12	7AT/6MT	F	R	Hatchback 4WD 651930	With Intermediate Shaft	2014700L	Drive Shaft		30	27	65.5	53.5	998
2.2 (130 kw)	2014.08-2018.12	7AT/6MT	F	L	Hatchback 4WD 651930		2350670L	Drive Shaft		30	27	65.5	53.5	537
	2014.08-2018.12	7AT/6MT	F	R	Hatchback 4WD 651930	With Intermediate Shaft	2014700L	Drive Shaft		30	27	65.5	53.5	998
	2014.08-2018.12	MT/DCT	F	L	Hatchback FWD 651930		2350670L	Drive Shaft		30	27	65.5	53.5	537
	2014.08-2018.12	MT/DCT	F	R	Hatchback FWD 651930	With Intermediate Shaft	2014700L	Drive Shaft		30	27	65.5	53.5	998
B250														
2.0 (155 kw)	2012.05-2018.12	MT/DCT	F	L	Hatchback FWD 270920		2350670L	Drive Shaft		30	27	65.5	53.5	537
	2014.08-2018.12	AT	F	L	Hatchback 4WD 270920		2350670L	Drive Shaft		30	27	65.5	53.5	537
C160														
1.5 (95 kw)	2019.06-	9AT	R	L/R	Estate RWD 264915		2037940L	Drive Shaft		27	27	68.5	72	782
	2019.06-	9AT	R	L/R	Saloon RWD 264915		2037940L	Drive Shaft		27	27	68.5	72	782
1.6 (95 kw)	2015.04-	7AT	R	R	Estate RWD 274910	Date To:2016.10	2351060L	Drive Shaft		27	27	68.5	72	783
	2015.04-	6MT	R	L	Saloon RWD 274910	Veh Prd Country:USA	2351090L	Drive Shaft		27	27	68.5	72	783
	2015.04-	7AT	R	R	Saloon RWD 274910	Date To:2015.10, To Chassis R134785, Veh Prd Country:South Africa	2351060L	Drive Shaft		27	27	68.5	72	783
C180														
1.5 (115 kw)	2019.06-	9AT	R	L/R	Cabriolet RWD 264915		2037940L	Drive Shaft		27	27	68.5	72	782
	2019.06-	9AT	R	L/R	Coupe RWD 264915		2037940L	Drive Shaft		27	27	68.5	72	782
	2019.06-	9AT	R	L/R	Estate RWD 264915		2037940L	Drive Shaft		27	27	68.5	72	782
	2019.06-	9AT	R	L/R	Saloon RWD 264915		2037940L	Drive Shaft		27	27	68.5	72	782
1.6 (85 kw)	2014.05-2018.05	7AT	R	L	Saloon RWD 626951	Date To:2016.04, To Chassis R186403, For SA code:M013	2351090L	Drive Shaft		27	27	68.5	72	783
	2014.05-2018.05	7AT	R	R	Saloon RWD 626951	For SA code:M013, All Version: 2053504019	2351060L	Drive Shaft		27	27	68.5	72	783
1.6 (90 kw)	2018.05-	9AT	R	R	Estate RWD 654916		2037940L	Drive Shaft		27	27	68.5	72	782
	2018.05-	9AT	R	R	Saloon RWD 654916		2037940L	Drive Shaft		27	27	68.5	72	782
1.6 (110 kw)	2018.10-	9AT	R	L/R	Saloon RWD 274910		2037940L	Drive Shaft		27	27	68.5	72	782
	2018.11-	9AT	R	L/R	Coupe RWD 274910		2037940L	Drive Shaft		27	27	68.5	72	782
1.6 (115 kw)	2013.07-	6MT	R	L	Saloon RWD 274910	Veh Prd Country:USA	2351090L	Drive Shaft		27	27	68.5	72	783
	2013.07-	6MT	R	R	Saloon RWD 274910	For SA code:806, Date To:2016.05, To Chassis R186275, Veh Prd Country:USA	2351060L	Drive Shaft		27	27	68.5	72	783
	2013.07-	7AT	R	R	Saloon RWD 274910	Date To:2015.10, To Chassis R186403, Veh Prd Country:USA	2351060L	Drive Shaft		27	27	68.5	72	783
	2013.07-	9AT	R	L/R	Saloon RWD 274910		2037940L	Drive Shaft		27	27	68.5	72	782
	2014.09-	6MT	R	L	Estate RWD 274910	Model year to:2015	2351090L	Drive Shaft		27	27	68.5	72	783
	2014.09-	6MT	R	R	Estate RWD 274910	Model year to:2015	2351060L	Drive Shaft		27	27	68.5	72	783
	2014.09-	7AT	R	R	Estate RWD 274910	For SA code:805/806	2351060L	Drive Shaft		27	27	68.5	72	783
	2014.09-	9AT	R	L/R	Estate RWD 274910		2037940L	Drive Shaft		27	27	68.5	72	782
	2015.10-	6MT	R	R	Coupe RWD 274910	Date From:2018.09	2037940L	Drive Shaft		27	27	68.5	72	782
C200														
1.5 (135 kw)	2018.04-	9AT	F	L	Estate 4WD 264915		2036790L	Drive Shaft		30	27	71	56	526
	2018.04-	9AT	R	L/R	Estate 4WD 264915		2037940L	Drive Shaft		27	27	68.5	72	782
	2018.04-	9AT	R	L/R	Estate RWD 264915		2037940L	Drive Shaft		27	27	68.5	72	782
	2018.04-	9AT	F	L	Saloon 4WD 264915		2036790L	Drive Shaft		30	27	71	56	526
	2018.04-	9AT	R	R	Saloon 4WD 264915		2037940L	Drive Shaft		27	27	68.5	72	782
	2018.04-	9AT	R	R	Saloon RWD 264915		2037940L	Drive Shaft		27	27	68.5	72	782
	2018.05-	9AT	F	L	Cabriolet 4WD 264915		2036790L	Drive Shaft		30	27	71	56	526
	2018.05-	9AT	R	L/R	Cabriolet 4WD 264915		2037940L	Drive Shaft		27	27	68.5	72	782
	2018.05-	9AT	R	L/R	Cabriolet RWD 264915		2037940L	Drive Shaft		27	27	68.5	72	782
	2018.05-	9AT	F	L	Coupe 4WD 264915		2036790L	Drive Shaft		30	27	71	56	526
	2018.05-	9AT	R	L/R	Coupe 4WD 264915		2037940L	Drive Shaft		27	27	68.5	72	782
	2018.05-	9AT	R	L/R	Coupe RWD 264915		2037940L	Drive Shaft		27	27	68.5	72	782
1.6 (100 kw)	2014.05-2018.05	7AT	R	L	Saloon RWD 626951	Date To:2016.04, To Chassis R186403, For SA code:M013	2351090L	Drive Shaft		27	27	68.5	72	783



	 YEAR	TRANSM.	F/R	L/R	BODY STYLE & DRIVE TYPE & ENGINE	REMARKS	GSP Ref.	 PRODUCT	 ABS	Technical Specifications				
										A	B	C	H	L
MERCEDES-BENZ C200														
1.6 (100 kw)	2014.05-2018.05	7AT	R	R	Saloon RWD 626951	For SA code:M013,All Version:2053504019	2351060L	Drive Shaft		27	27	68.5	72	783
1.6 (118 kw)	2018.05-	9AT	R	R	Estate RWD 654916		2037940L	Drive Shaft		27	27	68.5	72	782
	2018.05-	9AT	R	R	Saloon RWD 654916		2037940L	Drive Shaft		27	27	68.5	72	782
	2018.07-	9AT	R	R	Cabriolet RWD 654916		2037940L	Drive Shaft		27	27	68.5	72	782
	2018.07-	9AT	R	R	Coupe RWD 654916		2037940L	Drive Shaft		27	27	68.5	72	782
2.0 (135 kw)	2013.12-2018.08	6MT	R	L	Saloon RWD 274920	Date to:2016.04	2351090L	Drive Shaft		27	27	68.5	72	783
	2013.12-2018.08	6MT	R	R	Saloon RWD 274920	Date To:2016.05,To Chassis:R195675	2351060L	Drive Shaft		27	27	68.5	72	783
	2013.12-2018.08	7AT	R	R	Saloon RWD 274920	Veh Prd Country:South Africa	2351060L	Drive Shaft		27	27	68.5	72	783
	2013.12-2018.08		R	L/R	Saloon RWD 274920	For Modelcode:205042	2037940L	Drive Shaft		27	27	68.5	72	782
	2014.09-2018.05	6MT	R	L	Estate RWD 274920	Date To:2016.04	2351090L	Drive Shaft		27	27	68.5	72	783
	2014.09-2018.05	6MT	R	R	Estate RWD 274920		2351090L	Drive Shaft		27	27	68.5	72	783
	2014.09-2018.05	7AT	R	L	Estate RWD 274920	Inner teeth of transm.side:28	2037940L	Drive Shaft		27	27	68.5	72	782
	2014.09-2018.05	7AT	R	L/R	Estate RWD 274920		2351060L	Drive Shaft		27	27	68.5	72	783
	2014.09-2018.05	9AT	R	L/R	Estate RWD 274920	Date from:2016.05	2037940L	Drive Shaft		27	27	68.5	72	782
	2015.04-2018.05	7AT	F	R	Estate 4WD 274920		2032310L	Drive Shaft		30	27	71	56	556
	2015.04-2018.05	7AT/9AT	F	L	Estate 4WD 274920		2036790L	Drive Shaft		30	27	71	56	526
	2015.04-2018.05	7AT	R	L	Estate 4WD 274920	Date From:2016.05	2351060L	Drive Shaft		27	27	68.5	72	783
	2015.04-2018.05	7AT	R	L	Estate 4WD 274920	Date To:2016.04	2351090L	Drive Shaft		27	27	68.5	72	783
	2015.04-2018.05	7AT	R	R	Estate 4WD 274920		2351060L	Drive Shaft		27	27	68.5	72	783
	2015.04-2018.08	7AT	F	R	Saloon 4WD 274920	For left-hand drive vehicles	2032310L	Drive Shaft		30	27	71	56	556
	2015.04-2018.08	7AT/9AT	F	L	Saloon 4WD 274920		2036790L	Drive Shaft		30	27	71	56	526
	2015.04-2018.08	7AT	R	L	Saloon 4WD 274920	Veh Prd Country:South Africa	2351090L	Drive Shaft		27	27	68.5	72	783
	2015.04-2018.08	7AT	R	R	Saloon 4WD 274920		2351060L	Drive Shaft		27	27	68.5	72	783
	2015.10-2018.05	AT	R	L	Coupe RWD 274920	Date From:2016.11	2037940L	Drive Shaft		27	27	68.5	72	782
	2016.04-2018.05	9AT	F	L	Coupe 4WD 274920		2036790L	Drive Shaft		30	27	71	56	526
2016.06-2018.05	9AT	F	L	Cabriolet 4WD 274920		2036790L	Drive Shaft		30	27	71	56	526	
2.0 (150 kw)	2019.08-	9AT	F	L	Saloon 4WD 264920		2036790L	Drive Shaft		30	27	71	56	526
2.2 (100 kw)	2015.10-2018.05	7AT	R	L	Estate RWD 651921		2351090L	Drive Shaft		27	27	68.5	72	783
	2015.10-2018.05	7AT	R	R	Estate RWD 651921		2351060L	Drive Shaft		27	27	68.5	72	783
	2015.10-2018.05	9AT	R	R	Estate RWD 651921		2037940L	Drive Shaft		27	27	68.5	72	782
	2015.10-2018.05	7AT	R	R	Saloon RWD 651921	Veh Prd Country:South Africa,All Version:2053504019	2351060L	Drive Shaft		27	27	68.5	72	783
	2015.10-2018.05	9AT	R	R	Saloon RWD 651921		2037940L	Drive Shaft		27	27	68.5	72	782
C220														
2.0 (143 kw)	2018.05-	9AT	F	L	Estate 4WD 654920		2036790L	Drive Shaft		30	27	71	56	526
	2018.05-	9AT	F	L	Saloon 4WD 654920		2036790L	Drive Shaft		30	27	71	56	526
	2018.06-	9AT	F	L	Cabriolet 4WD 654920		2036790L	Drive Shaft		30	27	71	56	526
	2018.06-	9AT	F	L	Coupe 4WD 654920		2036790L	Drive Shaft		30	27	71	56	526
2.2 (120 kw)	2008.12-2014.01	6MT	R	L/R	Estate RWD 651911	Model year to:2001	2037930L	Drive Shaft	48NS	27	30	68	72	767
	2013.12-2016.05	7AT	R	L	Saloon RWD 651921	Date To:2015.03	2351090L	Drive Shaft		27	27	68.5	72	783
	2013.12-2016.05	7AT	R	R	Saloon RWD 651921	See 10.2015.03,All Prd Country:USA,All Prd Country:South Africa,All Version:2053504019	2351060L	Drive Shaft		27	27	68.5	72	783
	2014.09-2018.05	7AT	R	L	Estate RWD 651921		2351090L	Drive Shaft		27	27	68.5	72	783
	2014.09-2018.05	7AT	R	R	Estate RWD 651921		2351060L	Drive Shaft		27	27	68.5	72	783
2.2 (125 kw)	2008.12-2014.01	MT	R	L/R	Estate RWD 651911		2037930L	Drive Shaft	48NS	27	30	68	72	767
	2013.12-2018.05	7AT	R	L	Saloon RWD 651921	Date To:2015.03	2351090L	Drive Shaft		27	27	68.5	72	783
	2013.12-2018.05	7AT	R	R	Saloon RWD 651921	See 10.2015.03,All Prd Country:USA,All Prd Country:South Africa,All Version:2053504019	2351060L	Drive Shaft		27	27	68.5	72	783
	2013.12-2018.05	7AT/9AT	R	R	Saloon RWD 651921		2037940L	Drive Shaft		27	27	68.5	72	782
	2014.09-2018.05	7AT	R	L	Estate RWD 651921		2351090L	Drive Shaft		27	27	68.5	72	783
	2014.09-2018.05	7AT	R	R	Estate RWD 651921		2351060L	Drive Shaft		27	27	68.5	72	783
	2015.04-2018.05	7AT	F	R	Estate 4WD 651921		2032310L	Drive Shaft		30	27	71	56	556
	2015.04-2018.05	7AT/9AT	F	L	Estate 4WD 651921		2036790L	Drive Shaft		30	27	71	56	526
	2015.04-2018.05	6MT/7AT/9AT	F	L	Saloon 4WD 651921		2036790L	Drive Shaft		30	27	71	56	526
	2015.04-2018.05	6MT/7AT/9AT	F	R	Saloon 4WD 651921	For left-hand drive vehicles	2032310L	Drive Shaft		30	27	71	56	556
	2015.04-2018.05	7AT	R	R	Saloon 4WD 651921	For SA code:805	2037940L	Drive Shaft		27	27	68.5	72	782
	2016.04-2018.05	9AT	F	L	Coupe 4WD 651921		2036790L	Drive Shaft		30	27	71	56	526
2016.06-2018.05	9AT	F	L	Cabriolet 4WD 651921		2036790L	Drive Shaft		30	27	71	56	526	
C250														
2.0 (155 kw)	2014.03-2018.05	6MT	R	L	Saloon RWD 274920	Date to:2016.04	2351090L	Drive Shaft		27	27	68.5	72	783
	2014.03-2018.05	6MT	R	R	Saloon RWD 274920	Date To:2016.05,To Chassis:R195675	2351060L	Drive Shaft		27	27	68.5	72	783
	2014.03-2018.05	7AT	R	R	Saloon RWD 274920	Veh Prd Country:South Africa	2351060L	Drive Shaft		27	27	68.5	72	783
	2014.09-2018.05	6MT	R	L	Estate RWD 274920	Model year to:2015	2351090L	Drive Shaft		27	27	68.5	72	783
	2014.09-2018.05	7AT	R	L/R	Estate RWD 274920		2351060L	Drive Shaft		27	27	68.5	72	783
	2015.10-2018.05	9AT	R	L	Coupe RWD 274920		2037940L	Drive Shaft		27	27	68.5	72	782
2.2 (150 kw)	2008.08-2014.01	5AT/7AT/6MT	R	L/R	Saloon RWD 651911		2037930L	Drive Shaft	48NS	27	30	68	72	767
	2009.05-2014.01	5AT/7AT	R	L/R	Estate RWD 651911	For SA code:800/801/809	2037930L	Drive Shaft	48NS	27	30	68	72	767
	2009.05-2014.01	6MT	R	L/R	Estate RWD 651911		2037920L	Drive Shaft	48NS	27	30	68	72	768



	 YEAR	TRANSM.	F/R	L/R	BODY STYLE & DRIVE TYPE & ENGINE	REMARKS	GSP Ref.	 PRODUCT	 ABS	Technical Specifications				
										A	B	C	H	L
MERCEDES-BENZ C250														
2.2 (150 kw)	2011.06-2014.01	AT	R	L/R	Coupe RWD 651911		2037930L	Drive Shaft	48NS	27	30	68	72	767
	2011.06-2014.01	MT	R	L/R	Coupe RWD 651911		2037920L	Drive Shaft	48NS	27	30	68	72	768
	2014.02-2018.05	6MT/7AT/9AT	F	L	Saloon 4WD 651921		2036790L	Drive Shaft		30	27	71	56	526
	2014.02-2018.05	6MT/7AT/9AT	F	R	Saloon 4WD 651921	For left-hand drive vehicles	2032310L	Drive Shaft		30	27	71	56	556
	2014.02-2018.05	7AT	R	L	Saloon RWD 651921	Date to:2015.03	2351090L	Drive Shaft		27	27	68.5	72	783
	2014.02-2018.05	7AT	R	R	Saloon RWD 651921		2351060L	Drive Shaft		27	27	68.5	72	783
	2014.02-2018.05	7AT/9AT	R	R	Saloon RWD 651921		2037940L	Drive Shaft		27	27	68.5	72	782
	2014.10-2018.05	7AT	F	R	Estate 4WD 651921		2032310L	Drive Shaft		30	27	71	56	556
	2014.10-2018.05	7AT/9AT	F	L	Estate 4WD 651921		2036790L	Drive Shaft		30	27	71	56	526
	2016.04-2018.05	9AT	F	L	Coupe 4WD 651921		2036790L	Drive Shaft		30	27	71	56	526
C300														
2.0 (180 kw)	2015.01-2018.08	7AT	R	R	Saloon RWD 274920	Veh Prd Country:South Africa	2351060L	Drive Shaft		27	27	68.5	72	783
	2015.09-2018.08	7AT	F	R	Saloon 4WD 274920	For left-hand drive vehicles	2032310L	Drive Shaft		30	27	71	56	556
	2015.09-2018.08	7AT/9AT	F	L	Saloon 4WD 274920		2036790L	Drive Shaft		30	27	71	56	526
	2015.09-2018.08	7AT	R	L	Saloon 4WD 274920	Veh Prd Country:South Africa	2351090L	Drive Shaft		27	27	68.5	72	783
	2015.09-2018.08	7AT	R	R	Saloon 4WD 274920		2351060L	Drive Shaft		27	27	68.5	72	783
	2018.06-	9AT	F	L	Estate 4WD 654920		2036790L	Drive Shaft		30	27	71	56	526
	2018.06-	9AT	F	L	Saloon 4WD 654920		2036790L	Drive Shaft		30	27	71	56	526
	2018.07-	9AT	F	L	Coupe 4WD 654920		2036790L	Drive Shaft		30	27	71	56	526
2.0 (190 kw)	2018.05-	9AT	F	L	Coupe 4WD 264920		2036790L	Drive Shaft		30	27	71	56	526
	2018.05-	9AT	R	R	Coupe 4WD 264920		2037940L	Drive Shaft		27	27	68.5	72	782
	2018.05-	9AT	F	L	Estate 4WD 264920		2036790L	Drive Shaft		30	27	71	56	526
	2018.05-	9AT	R	R	Estate 4WD 264920		2037940L	Drive Shaft		27	27	68.5	72	782
	2018.05-	9AT	F	L	Saloon 4WD 264920		2036790L	Drive Shaft		30	27	71	56	526
	2019.05-	9AT	F	L	Cabriolet 4WD 264920		2036790L	Drive Shaft		30	27	71	56	526
	2019.05-	9AT	R	R	Cabriolet 4WD 264920		2037940L	Drive Shaft		27	27	68.5	72	782
	2019.05-	9AT	F	L	Coupe 4WD 264920		2036790L	Drive Shaft		30	27	71	56	526
	2019.05-	9AT	R	R	Coupe 4WD 264920		2037940L	Drive Shaft		27	27	68.5	72	782
	2019.05-	9AT	F	L	Estate 4WD 264920		2036790L	Drive Shaft		30	27	71	56	526
	2019.05-	9AT	R	R	Estate 4WD 264920		2037940L	Drive Shaft		27	27	68.5	72	782
	2019.05-	9AT	F	L	Saloon 4WD 264920		2036790L	Drive Shaft		30	27	71	56	526
C320														
3.0 (165 kw)	2007.02-2014.01	AT/MT	R	L/R	Saloon RWD 642960		2037920L	Drive Shaft	48NS	27	30	68	72	768
	2007.11-2010.12	AT/MT	R	L/R	Estate RWD 642960		2037920L	Drive Shaft	48NS	27	30	68	72	768
C350														
3.0 (165 kw)	2007.02-2014.01	7AT/6MT	R	L/R	Saloon RWD 642830/642960		2037920L	Drive Shaft	48NS	27	30	68	72	768
	2007.11-2011.12	7AT/6MT	R	L/R	Estate RWD 642830/642960		2037920L	Drive Shaft	48NS	27	30	68	72	768
3.0 (170 kw)	2009.07-2014.01	7AT/6MT	R	L/R	Estate RWD 642830		2037920L	Drive Shaft	48NS	27	30	68	72	768
	2009.07-2014.01	7AT	R	L/R	Saloon RWD 642830		2037920L	Drive Shaft	48NS	27	30	68	72	768
C400														
3.0 (245 kw)	2014.10-	7AT/9AT	F	L	Estate 4WD 276823		2036790L	Drive Shaft		30	27	71	56	526
	2014.10-	7AT/9AT	F	L	Saloon 4WD 276823		2036790L	Drive Shaft		30	27	71	56	526
	2014.10-	7AT/9AT	F	R	Saloon 4WD 276823		2032310L	Drive Shaft		30	27	71	56	556
	2014.10-	AT	R	L	Saloon 4WD 276823		2351090L	Drive Shaft		27	27	68.5	72	783
	2014.10-	AT	R	R	Saloon 4WD 276823		2351060L	Drive Shaft		27	27	68.5	72	783
	2016.04-	9AT	F	L	Coupe 4WD 276823		2036790L	Drive Shaft		30	27	71	56	526
	2016.06-	9AT	F	L	Cabriolet 4WD 276823		2036790L	Drive Shaft		30	27	71	56	526
C43 AMG														
3.0 (270 kw)	2016.04-2018.05	9AT	F	L	Coupe 4WD 276823		2036790L	Drive Shaft		30	27	71	56	526
	2016.04-2018.05	9AT	R	L	Coupe 4WD 276823		2037940L	Drive Shaft		27	27	68.5	72	782
	2016.04-2018.05	9AT	R	R	Coupe 4WD 276823	Date From:2016.05	2037940L	Drive Shaft		27	27	68.5	72	782
	2016.04-2018.05	9AT	R	R	Coupe 4WD 276823	Date To:2016.04	2351060L	Drive Shaft		27	27	68.5	72	783
	2016.04-2018.05	9AT	F	L	Estate 4WD 276823		2036790L	Drive Shaft		30	27	71	56	526
	2016.04-2018.05	9AT	R	L/R	Estate 4WD 276823		2037940L	Drive Shaft		27	27	68.5	72	782
	2016.04-2018.05	9AT	F	L	Saloon 4WD 276823		2036790L	Drive Shaft		30	27	71	56	526
	2016.04-2018.05	9AT	R	L/R	Saloon 4WD 276823		2037940L	Drive Shaft		27	27	68.5	72	782
	2016.10-2018.05	9AT	F	L	Cabriolet 4WD 276823		2036790L	Drive Shaft		30	27	71	56	526
	2016.10-2018.05	9AT	R	L/R	Cabriolet 4WD 276823		2037940L	Drive Shaft		27	27	68.5	72	782
3.0 (287 kw)	2018.05-	9AT	F	L	Cabriolet 4WD 276823		2036790L	Drive Shaft		30	27	71	56	526
	2018.05-	9AT	R	L/R	Cabriolet 4WD 276823		2037940L	Drive Shaft		27	27	68.5	72	782
	2018.05-	9AT	F	L	Coupe 4WD 276823		2036790L	Drive Shaft		30	27	71	56	526
	2018.05-	9AT	R	L/R	Coupe 4WD 276823		2037940L	Drive Shaft		27	27	68.5	72	782
	2018.05-	9AT	F	L	Estate 4WD 276823		2036790L	Drive Shaft		30	27	71	56	526
	2018.05-	9AT	R	L/R	Estate 4WD 276823		2037940L	Drive Shaft		27	27	68.5	72	782
	2018.05-	9AT	F	L	Saloon 4WD 276823		2036790L	Drive Shaft		30	27	71	56	526



  YEAR	TRANSM.	F/R	L/R	BODY STYLE & DRIVE TYPE & ENGINE	REMARKS	GSP Ref.	 PRODUCT ABS	Technical Specifications						
								A	B	C	H	L		
MERCEDES-BENZ														
C43 AMG														
3.0 (287 kw)	2018.05-	9AT	R	L/R	Saloon 4WD 276823		203794OL	Drive Shaft		27	27	68.5	72	782
C450 AMG														
3.0 (270 kw)	2015.04-2018.05	7AT	F	L	Estate 4WD 276823		203679OL	Drive Shaft		30	27	71	56	526
	2015.04-2018.05	7AT	F	R	Estate 4WD 276823	For left-hand drive vehicles	203231OL	Drive Shaft		30	27	71	56	556
	2015.04-2018.05	7AT	R	L/R	Estate 4WD 276823	Date From:2015.08	203794OL	Drive Shaft		27	27	68.5	72	782
	2015.04-2018.05	7AT	R	L/R	Estate 4WD 276823	Date To:2015.07	235106OL	Drive Shaft		27	27	68.5	72	783
	2015.04-2018.05	7AT	F	L	Saloon 4WD 276823		203679OL	Drive Shaft		30	27	71	56	526
	2015.04-2018.05	7AT	F	R	Saloon 4WD 276823	For left-hand drive vehicles	203231OL	Drive Shaft		30	27	71	56	556
	2015.04-2018.05	7AT	R	L/R	Saloon 4WD 276823	Date From:2015.08	203794OL	Drive Shaft		27	27	68.5	72	782
	2015.04-2018.05	7AT	R	L/R	Saloon 4WD 276823	Date To:2015.07	235106OL	Drive Shaft		27	27	68.5	72	783
C63 AMG														
6.2 (380 kw)	2012.01-2014.01	7AT	R	L/R	Coupe RWD 156985		235119OL	Drive Shaft	48NS	27	27	45	79	803
CL500														
4.7 (320 kw)	2010.10-2013.12	7AT	R	L/R	Coupe 4WD 278920		235119OL	Drive Shaft	48NS	27	27	45	79	803
5.5 (285 kw)	2008.02-2013.12	7AT	R	L/R	Coupe 4WD 273968		235119OL	Drive Shaft	48NS	27	27	45	79	803
CLA180														
1.5 (80 kw)	2013.10-2018.05	AT/MT	F	L	Coupe FWD 607951		235067OL	Drive Shaft		30	27	65.5	53.5	537
	2015.07-2018.05	MT/DCT	F	L	Estate FWD 607951		235067OL	Drive Shaft		30	27	65.5	53.5	537
1.6 (90 kw)	2013.01-2019.03	AT/MT	F	L	Coupe FWD 270910		235067OL	Drive Shaft		30	27	65.5	53.5	537
	2015.01-2019.03	AT/MT	F	L	Estate FWD 270910		235067OL	Drive Shaft		30	27	65.5	53.5	537
CLA200														
1.6 (110 kw)	2018.07-2019.03	7AT/6MT	F	L	Coupe FWD 270910		235067OL	Drive Shaft		30	27	65.5	53.5	537
1.6 (115 kw)	2013.01-2019.03	AT/MT	F	L	Coupe FWD 270910		235067OL	Drive Shaft		30	27	65.5	53.5	537
	2015.01-2019.03	AT/MT	F	L	Estate FWD 270910		235067OL	Drive Shaft		30	27	65.5	53.5	537
1.8 (100 kw)	2013.06-2014.08	AT/MT	F	L	Coupe FWD 651901		235067OL	Drive Shaft		30	27	65.5	53.5	537
	2013.06-2014.08	AT/MT	F	R	Coupe FWD 651901	With Intermediate Shaft	201470OL	Drive Shaft		30	27	65.5	53.5	998
2.2 (100 kw)	2014.07-2019.03	MT/DCT	F	L	Coupe 4WD 651930		235067OL	Drive Shaft		30	27	65.5	53.5	537
	2014.07-2019.03	MT/DCT	F	R	Coupe 4WD 651930	With Intermediate Shaft	201470OL	Drive Shaft		30	27	65.5	53.5	998
	2014.07-2019.03	AT/MT	F	L	Coupe FWD 651930		235067OL	Drive Shaft		30	27	65.5	53.5	537
	2014.07-2019.03	AT/MT	F	R	Coupe FWD 651930	With Intermediate Shaft	201470OL	Drive Shaft		30	27	65.5	53.5	998
	2015.01-2019.03	DCT	F	L	Estate 4WD 651930		235067OL	Drive Shaft		30	27	65.5	53.5	537
	2015.01-2019.03	DCT	F	R	Estate 4WD 651930	With Intermediate Shaft	201470OL	Drive Shaft		30	27	65.5	53.5	998
	2015.01-2019.03	AT/MT	F	L	Estate FWD 651930		235067OL	Drive Shaft		30	27	65.5	53.5	537
	2015.01-2019.03	AT/MT	F	R	Estate FWD 651930	With Intermediate Shaft	201470OL	Drive Shaft		30	27	65.5	53.5	998
CLA220														
2.0 (135 kw)	2015.01-2019.03	7AT	F	L	Coupe 4WD 270920		235067OL	Drive Shaft		30	27	65.5	53.5	537
	2016.04-2019.03	7AT	F	L	Estate 4WD 270920		235067OL	Drive Shaft		30	27	65.5	53.5	537
2.2 (120 kw)	2013.01-2019.03	MT/DCT	F	L	Coupe FWD 651930		235067OL	Drive Shaft		30	27	65.5	53.5	537
	2013.01-2019.03	MT/DCT	F	R	Coupe FWD 651930	With Intermediate Shaft	201470OL	Drive Shaft		30	27	65.5	53.5	998
	2014.08-2019.03	7AT/6MT	F	L	Coupe 4WD 651930		235067OL	Drive Shaft		30	27	65.5	53.5	537
	2014.08-2019.03	7AT/6MT	F	R	Coupe 4WD 651930	With Intermediate Shaft	201470OL	Drive Shaft		30	27	65.5	53.5	998
	2015.01-2019.03	7AT	F	L	Estate FWD 651930		235067OL	Drive Shaft		30	27	65.5	53.5	537
	2015.01-2019.03	7AT	F	R	Estate FWD 651930	With Intermediate Shaft	201470OL	Drive Shaft		30	27	65.5	53.5	998
	2015.09-2019.03	7AT	F	L	Estate 4WD 651930		235067OL	Drive Shaft		30	27	65.5	53.5	537
	2015.09-2019.03	7AT	F	R	Estate 4WD 651930	With Intermediate Shaft	201470OL	Drive Shaft		30	27	65.5	53.5	998
2.2 (125 kw)	2013.01-2019.03	MT/DCT	F	L	Coupe FWD 651930		235067OL	Drive Shaft		30	27	65.5	53.5	537
	2013.01-2019.03	MT/DCT	F	R	Coupe FWD 651930	With Intermediate Shaft	201470OL	Drive Shaft		30	27	65.5	53.5	998
	2014.07-2019.03	MT/DCT	F	L	Coupe 4WD 651930		235067OL	Drive Shaft		30	27	65.5	53.5	537
	2014.07-2019.03	MT/DCT	F	R	Coupe 4WD 651930	With Intermediate Shaft	201470OL	Drive Shaft		30	27	65.5	53.5	998
	2018.07-2019.03	7AT	F	L	Estate 4WD 651930		235067OL	Drive Shaft		30	27	65.5	53.5	537
	2018.07-2019.03	7AT	F	R	Estate 4WD 651930	With Intermediate Shaft	201470OL	Drive Shaft		30	27	65.5	53.5	998
	2018.07-2019.03	7AT	F	L	Estate FWD 651930		235067OL	Drive Shaft		30	27	65.5	53.5	537
	2018.07-2019.03	7AT	F	R	Estate FWD 651930	With Intermediate Shaft	201470OL	Drive Shaft		30	27	65.5	53.5	998
2.2 (130 kw)	2014.09-2019.03	AT	F	L	Coupe 4WD 651930		235067OL	Drive Shaft		30	27	65.5	53.5	537
	2014.09-2019.03	AT	F	R	Coupe 4WD 651930	With Intermediate Shaft	201470OL	Drive Shaft		30	27	65.5	53.5	998
	2014.09-2019.03	MT/DCT	F	L	Coupe FWD 651930		235067OL	Drive Shaft		30	27	65.5	53.5	537
	2014.09-2019.03	MT/DCT	F	R	Coupe FWD 651930	With Intermediate Shaft	201470OL	Drive Shaft		30	27	65.5	53.5	998
	2015.01-2019.03	7AT	F	L	Estate 4WD 651930		235067OL	Drive Shaft		30	27	65.5	53.5	537
	2015.01-2019.03	7AT	F	R	Estate 4WD 651930	With Intermediate Shaft	201470OL	Drive Shaft		30	27	65.5	53.5	998
	2015.01-2019.03	7AT	F	L	Estate FWD 651930		235067OL	Drive Shaft		30	27	65.5	53.5	537
	2015.01-2019.03	7AT	F	R	Estate FWD 651930	With Intermediate Shaft	201470OL	Drive Shaft		30	27	65.5	53.5	998
CLA250														
2.0 (155 kw)	2013.01-2019.03	AT	F	L	Coupe FWD 270920		235067OL	Drive Shaft		30	27	65.5	53.5	537
	2013.07-2019.03	AT	F	L	Coupe 4WD 270920		235067OL	Drive Shaft		30	27	65.5	53.5	537
	2015.01-2019.03	AT	F	L	Estate 4WD 270920		235067OL	Drive Shaft		30	27	65.5	53.5	537



		TRANSM.	F/R	L/R	BODY STYLE & DRIVE TYPE & ENGINE	REMARKS	GSP Ref.		ABS	Technical Specifications				
										A	B	C	H	L
MERCEDES-BENZ CLA250														
2.0 (155 kw)	2015.01-2019.03	MT/DCT	F	L	Estate FWD 270920		2350670L	Drive Shaft		30	27	65.5	53.5	537
2.0 (160 kw)	2015.07-2019.03	DCT	F	L	Coupe 4WD 270920		2350670L	Drive Shaft		30	27	65.5	53.5	537
	2015.07-2019.03	MT/DCT	F	L	Coupe FWD 270920		2350670L	Drive Shaft		30	27	65.5	53.5	537
	2015.07-2019.03	DCT	F	L	Estate 4WD 270920		2350670L	Drive Shaft		30	27	65.5	53.5	537
CLS220														
2.2 (120 kw)	2014.05-2017.12	9AT	R	L/R	Coupe RWD 651924		2351190L	Drive Shaft	48NS	27	27	45	79	803
	2014.05-2017.12	9AT	R	L/R	Estate RWD 651924		2351190L	Drive Shaft	48NS	27	27	45	79	803
2.2 (125 kw)	2014.05-2017.12	7AT/9AT	R	L/R	Coupe RWD 651924		2351190L	Drive Shaft	48NS	27	27	45	79	803
	2014.05-2017.12	7AT/9AT	R	L/R	Estate RWD 651924		2351190L	Drive Shaft	48NS	27	27	45	79	803
2.2 (130 kw)	2014.05-2017.12	7AT	R	L/R	Coupe RWD 651924		2351190L	Drive Shaft	48NS	27	27	45	79	803
	2014.05-2017.12	7AT	R	L/R	Estate RWD 651924		2351190L	Drive Shaft	48NS	27	27	45	79	803
CLS350														
2.0 (220 kw)	2018.08-	9AT	R	L	Coupe 4WD 264920		2037410L	Drive Shaft		27	27		82	800
	2018.08-	9AT	R	R	Coupe 4WD 264920		2037430L	Drive Shaft		27	27		82	800
3.0 (185 kw)	2013.02-2017.12	7AT/9AT	R	L/R	Coupe 4WD 642854/642858		2351190L	Drive Shaft	48NS	27	27	45	79	803
	2014.05-2017.12	7AT	R	L/R	Estate 4WD 642854/642858		2351190L	Drive Shaft	48NS	27	27	45	79	803
3.0 (190 kw)	2015.04-2017.12	9AT	R	L/R	Coupe 4WD 642854/642858		2351190L	Drive Shaft	48NS	27	27	45	79	803
	2015.04-2017.12	9AT	R	L/R	Estate 4WD 642854/642858		2351190L	Drive Shaft	48NS	27	27	45	79	803
3.0 (195 kw)	2011.09-2014.08	7AT	R	L/R	Coupe 4WD 642854		2351190L	Drive Shaft	48NS	27	27	45	79	803
	2012.10-2014.08	7AT	R	L/R	Estate 4WD 642854		2351190L	Drive Shaft	48NS	27	27	45	79	803
3.5 (225 kw)	2011.01-2014.08	7AT	R	L/R	Coupe RWD 276952		2351190L	Drive Shaft	48NS	27	27	45	79	803
	2012.10-2014.08	7AT	R	L/R	Estate RWD 276952		2351190L	Drive Shaft	48NS	27	27	45	79	803
CLS400														
3.0 (245 kw)	2014.05-2017.12	7AT	R	L/R	Coupe RWD 276820		2351190L	Drive Shaft	48NS	27	27	45	79	803
	2014.05-2017.12	7AT	R	L/R	Estate RWD 276820		2351190L	Drive Shaft	48NS	27	27	45	79	803
3.5 (245 kw)	2014.07-2017.12	7AT	R	L/R	Coupe RWD 276850		2351190L	Drive Shaft	48NS	27	27	45	79	803
	2014.07-2017.12	7AT	R	L/R	Estate RWD 276850		2351190L	Drive Shaft	48NS	27	27	45	79	803
CLS500														
4.7 (300 kw)	2011.09-2017.12	7AT/9AT	R	L/R	Coupe 4WD 278922		2351190L	Drive Shaft	48NS	27	27	45	79	803
	2012.10-2017.12	7AT/9AT	R	L/R	Estate 4WD 278922		2351190L	Drive Shaft	48NS	27	27	45	79	803
CLS63 AMG														
5.5 (386 kw)	2011.02-2017.12	7AT	R	L/R	Coupe RWD 157980/157981		2351190L	Drive Shaft	48NS	27	27	45	79	803
	2012.10-2017.12	7AT	R	L/R	Estate RWD 157981		2351190L	Drive Shaft	48NS	27	27	45	79	803
5.5 (410 kw)	2011.01-2017.12	7AT	R	L/R	Coupe RWD 157981		2351190L	Drive Shaft	48NS	27	27	45	79	803
	2013.05-2017.12	7AT	R	L/R	Coupe 4WD 157981		2351190L	Drive Shaft	48NS	27	27	45	79	803
	2013.05-2017.12	7AT	R	L/R	Estate 4WD 157981		2351190L	Drive Shaft	48NS	27	27	45	79	803
	2013.05-2017.12	7AT	R	L/R	Estate RWD 157981		2351190L	Drive Shaft	48NS	27	27	45	79	803
5.5 (430 kw)	2013.02-2017.12	7AT	R	L/R	Coupe 4WD 157981		2351190L	Drive Shaft	48NS	27	27	45	79	803
	2013.02-2017.12	7AT	R	L/R	Coupe RWD 157981		2351190L	Drive Shaft	48NS	27	27	45	79	803
	2013.02-2017.12	7AT	R	L/R	Estate 4WD 157981		2351190L	Drive Shaft	48NS	27	27	45	79	803
	2013.02-2017.12	7AT	R	L/R	Estate RWD 157981		2351190L	Drive Shaft	48NS	27	27	45	79	803
E180														
1.6 (115 kw)	2013.08-2015.12	7AT	R	L/R	Saloon RWD 274910	Date from:2014.04,Date to:2014.11	2351190L	Drive Shaft	48NS	27	27	45	79	803
E200														
1.8 (135 kw)	2009.01-2016.12	6MT	R	L/R	Estate RWD 271860		2351190L	Drive Shaft	48NS	27	27	45	79	803
2.0 (135 kw)	2013.01-2016.12	7AT/6MT	R	L/R	Estate RWD 274920		2351190L	Drive Shaft	48NS	27	27	45	79	803
	2013.01-2016.12	7AT	R	L/R	Saloon RWD 274920	Date from:2014.04	2351190L	Drive Shaft	48NS	27	27	45	79	803
	2016.07-	9AT	R	L	Saloon 4WD 274920		2037410L	Drive Shaft		27	27		82	800
	2016.07-	9AT	R	R	Saloon 4WD 274920		2037430L	Drive Shaft		27	27		82	800
	2017.01-	9AT	R	L	Estate 4WD 274920		2037410L	Drive Shaft		27	27		82	800
	2017.01-	9AT	R	R	Estate 4WD 274920		2037430L	Drive Shaft		27	27		82	800
	2017.06-	9AT	R	L	Coupe 4WD 274920		2037410L	Drive Shaft		27	27		82	800
	2017.06-	9AT	R	R	Coupe 4WD 274920		2037430L	Drive Shaft		27	27		82	800
	2017.10-	9AT	R	L	Cabriolet 4WD 274920		2037410L	Drive Shaft		27	27		82	800
	2017.10-	9AT	R	R	Cabriolet 4WD 274920		2037430L	Drive Shaft		27	27		82	800
2.0 (145 kw)	2019.06-	9AT	R	L/R	Cabriolet 4WD 264920		2037430L	Drive Shaft		27	27		82	800
	2019.06-	9AT	R	L/R	Coupe 4WD 264920		2037430L	Drive Shaft		27	27		82	800
	2019.06-	9AT	R	L/R	Estate 4WD 264920		2037430L	Drive Shaft		27	27		82	800
	2019.06-	9AT	R	L/R	Saloon 4WD 264920		2037430L	Drive Shaft		27	27		82	800
2.2 (100 kw)	2009.01-2015.12	7AT/9AT	R	L/R	Saloon RWD 651925		2351190L	Drive Shaft	48NS	27	27	45	79	803
	2009.01-2016.12	7AT/9AT	R	L/R	Estate RWD 651925		2351190L	Drive Shaft	48NS	27	27	45	79	803
E220														
2.2 (120 kw)	2009.01-2014.08	6MT/7AT	R	L/R	Estate RWD 651924		2351190L	Drive Shaft	48NS	27	27	45	79	803
	2009.01-2015.12	6MT	R	L/R	Saloon RWD 651924		2351190L	Drive Shaft	48NS	27	27	45	79	803
	2009.01-2015.12	7AT	R	L/R	Saloon RWD 651924	For SA code:800/051/801/427	2351190L	Drive Shaft	48NS	27	27	45	79	803



		TRANSM.	F/R	L/R	BODY STYLE & DRIVE TYPE & ENGINE	REMARKS	GSP Ref.		ABS	Technical Specifications				
										A	B	C	H	L
MERCEDES-BENZ E220														
2.2 (125 kw)	2009.01-2016.12	6MT/7AT/9AT	R	L/R	Estate RWD 651924		2351190L	Drive Shaft	48NS	27	27	45	79	803
	2009.01-2016.12	6MT/9AT	R	L/R	Saloon RWD 651924		2351190L	Drive Shaft	48NS	27	27	45	79	803
	2009.01-2016.12	7AT	R	L/R	Saloon RWD 651924	For SA code:800/051/801/427	2351190L	Drive Shaft	48NS	27	27	45	79	803
2.2 (130 kw)	2014.05-2015.12	7AT	R	L/R	Saloon RWD 651924		2351190L	Drive Shaft	48NS	27	27	45	79	803
	2015.05-2016.12	7AT	R	L/R	Estate RWD 651924		2351190L	Drive Shaft	48NS	27	27	45	79	803
E250														
1.8 (150 kw)	2009.01-2013.12	5AT/7AT	R	L/R	Estate RWD 271860		2351190L	Drive Shaft	48NS	27	27	45	79	803
	2009.01-2015.12	5AT/7AT	R	L/R	Saloon RWD 271860		2351190L	Drive Shaft	48NS	27	27	45	79	803
2.0 (155 kw)	2013.01-2016.12	7AT/6MT	R	L/R	Estate RWD 274920		2351190L	Drive Shaft	48NS	27	27	45	79	803
	2013.01-2016.12	7AT/6MT	R	L/R	Saloon RWD 274920		2351190L	Drive Shaft	48NS	27	27	45	79	803
2.2 (150 kw)	2009.01-2016.12	AT	R	L/R	Coupe RWD 651911		2037930L	Drive Shaft	48NS	27	30	68	72	767
	2009.01-2016.12	MT	R	L/R	Coupe RWD 651911		2037920L	Drive Shaft	48NS	27	30	68	72	768
	2010.01-2016.12	AT	R	L/R	Cabriolet RWD 651911		2037930L	Drive Shaft	48NS	27	30	68	72	767
	2010.01-2016.12	MT	R	L/R	Cabriolet RWD 651911		2037920L	Drive Shaft	48NS	27	30	68	72	768
E300														
3.5 (185 kw)	2011.07-2015.12	7AT	R	L/R	Saloon RWD 276952		2351190L	Drive Shaft	48NS	27	27	45	79	803
	2011.07-2016.12	7AT	R	L/R	Estate RWD 276952		2351190L	Drive Shaft	48NS	27	27	45	79	803
E350														
3.0 (170 kw)	2009.01-2011.06	7AT	R	L/R	Coupe RWD 642836		2037920L	Drive Shaft	48NS	27	30	68	72	768
	2010.01-2011.12	7AT	R	L/R	Cabriolet RWD 642836		2037920L	Drive Shaft	48NS	27	30	68	72	768
3.0 (185 kw)	2013.01-2015.12	7AT	R	L/R	Saloon 4WD 642858		2351190L	Drive Shaft	48NS	27	27	45	79	803
	2013.01-2016.12	7AT	R	L/R	Estate 4WD 642858		2351190L	Drive Shaft	48NS	27	27	45	79	803
	2013.03-2016.12	AT	R	L/R	Cabriolet RWD 642838		2037920L	Drive Shaft	48NS	27	30	68	72	768
	2013.06-2016.12	AT	R	L/R	Coupe RWD 642838		2037920L	Drive Shaft	48NS	27	30	68	72	768
3.0 (190 kw)	2014.05-2015.12	7AT	R	L/R	Saloon 4WD 642858		2351190L	Drive Shaft	48NS	27	27	45	79	803
	2014.05-2016.12	AT	R	L/R	Cabriolet RWD 642838		2037920L	Drive Shaft	48NS	27	30	68	72	768
	2014.05-2016.12	AT	R	L/R	Coupe RWD 642838		2037920L	Drive Shaft	48NS	27	30	68	72	768
	2014.05-2016.12	7AT	R	L/R	Estate 4WD 642858		2351190L	Drive Shaft	48NS	27	27	45	79	803
3.0 (195 kw)	2011.03-2015.12	7AT	R	L/R	Saloon 4WD 642858		2351190L	Drive Shaft	48NS	27	27	45	79	803
	2011.04-2013.12	7AT	R	L/R	Cabriolet RWD 642838		2037920L	Drive Shaft	48NS	27	30	68	72	768
	2011.06-2013.06	7AT	R	L/R	Coupe RWD 642838		2037920L	Drive Shaft	48NS	27	30	68	72	768
	2011.07-2013.12	7AT	R	L/R	Estate 4WD 642858		2351190L	Drive Shaft	48NS	27	27	45	79	803
3.5 (200 kw)	2009.01-2013.12	7AT	R	L/R	Saloon RWD 272980		2351190L	Drive Shaft	48NS	27	27	45	79	803
	2009.08-2011.12	7AT	R	L/R	Estate RWD 272980		2351190L	Drive Shaft	48NS	27	27	45	79	803
3.5 (215 kw)	2009.01-2011.08	7AT	R	L/R	Saloon RWD 272983		2351190L	Drive Shaft	48NS	27	27	45	79	803
	2009.01-2011.12	7AT	R	L/R	Estate RWD 272983		2351190L	Drive Shaft	48NS	27	27	45	79	803
3.5 (225 kw)	2011.09-2014.12	7AT	R	L/R	Estate RWD 276952		2351190L	Drive Shaft	48NS	27	27	45	79	803
	2011.09-2015.12	7AT	R	L/R	Saloon RWD 276952		2351190L	Drive Shaft	48NS	27	27	45	79	803
E400														
3.0 (245 kw)	2013.01-2016.12	7AT	R	L/R	Estate RWD 276820	Model year from:2014	2351190L	Drive Shaft	48NS	27	27	45	79	803
	2013.01-2016.12	7AT	R	L/R	Saloon RWD 276820	Model year from:2014	2351190L	Drive Shaft	48NS	27	27	45	79	803
	2013.03-2016.12	AT	R	L/R	Cabriolet RWD 276820		2037920L	Drive Shaft	48NS	27	30	68	72	768
	2013.03-2016.12	AT	R	L/R	Coupe RWD 276820		2037920L	Drive Shaft	48NS	27	30	68	72	768
3.5 (245 kw)	2014.07-2015.12	7AT	R	L/R	Saloon RWD 276850		2351190L	Drive Shaft	48NS	27	27	45	79	803
	2014.07-2016.12	7AT	R	L/R	Estate RWD 276850		2351190L	Drive Shaft	48NS	27	27	45	79	803
E500														
4.7 (300 kw)	2011.09-2015.12	7AT	R	L/R	Saloon 4WD 278922	Alt Version:2213501910	2351190L	Drive Shaft	48NS	27	27	45	79	803
	2011.09-2016.12	7AT	R	L/R	Estate 4WD 278922		2351190L	Drive Shaft	48NS	27	27	45	79	803
5.5 (285 kw)	2009.01-2016.12	7AT	R	L/R	Coupe RWD 273966		2037920L	Drive Shaft	48NS	27	30	68	72	768
	2010.01-2011.12	7AT	R	L/R	Cabriolet RWD 273966		2037920L	Drive Shaft	48NS	27	30	68	72	768
E63 AMG														
5.5 (386 kw)	2011.02-2016.12	7AT	R	L/R	Estate RWD 157981		2351190L	Drive Shaft	48NS	27	27	45	79	803
	2011.02-2016.12	7AT	R	L/R	Saloon RWD 157981		2351190L	Drive Shaft	48NS	27	27	45	79	803
5.5 (410 kw)	2010.10-2016.12	7AT	R	L/R	Estate RWD 157981		2351190L	Drive Shaft	48NS	27	27	45	79	803
	2011.05-2016.12	7AT	R	L/R	Saloon RWD 157981		2351190L	Drive Shaft	48NS	27	27	45	79	803
	2013.01-2016.12	7AT	R	L/R	Estate 4WD 157981		2351190L	Drive Shaft	48NS	27	27	45	79	803
	2013.01-2016.12	7AT	R	L/R	Saloon 4WD 157981		2351190L	Drive Shaft	48NS	27	27	45	79	803
5.5 (430 kw)	2013.01-2016.12	7AT	R	L/R	Estate 4WD 157981		2351190L	Drive Shaft	48NS	27	27	45	79	803
	2013.01-2016.12	7AT	R	L/R	Saloon 4WD 157981		2351190L	Drive Shaft	48NS	27	27	45	79	803
	2013.06-2016.12	7AT	R	L/R	Estate RWD 157981		2351190L	Drive Shaft	48NS	27	27	45	79	803
	2013.06-2016.12	7AT	R	L/R	Saloon RWD 157981		2351190L	Drive Shaft	48NS	27	27	45	79	803
6.2 (386 kw)	2009.12-2015.12	7AT	R	L/R	Saloon RWD 156985		2351190L	Drive Shaft	48NS	27	27	45	79	803
GL320														
3.0 (155 kw)	2009.12-2012.08	7AT	F	L	SUV 4WD 642820		2050600L	Drive Shaft		30	37	70.2	90.5	665
	2009.12-2012.08	7AT	F	R	SUV 4WD 642820		2050610L	Drive Shaft		30	37	70.2	90.5	1004



		TRANSM.	F/R	L/R	BODY STYLE & DRIVE TYPE & ENGINE	REMARKS	GSP Ref.		Technical Specifications					
									PRODUCT	ABS	A	B	C	H
MERCEDES-BENZ GL320														
3.0 (165 kw)	2006.09-2009.05	7AT	F	L	SUV 4WD 642940		2050600L	Drive Shaft		30	37	70.2	90.5	665
	2006.09-2009.05	7AT	F	R	SUV 4WD 642940		2050610L	Drive Shaft		30	37	70.2	90.5	1004
GL350														
3.0 (155 kw)	2009.06-2012.08	7AT	F	L	SUV 4WD 642820		2050600L	Drive Shaft		30	37	70.2	90.5	665
	2009.06-2012.08	7AT	F	R	SUV 4WD 642820		2050610L	Drive Shaft		30	37	70.2	90.5	1004
3.0 (165 kw)	2009.06-2012.08	7AT	F	L	SUV 4WD 642940		2050600L	Drive Shaft		30	37	70.2	90.5	665
	2009.06-2012.08	7AT	F	R	SUV 4WD 642940		2050610L	Drive Shaft		30	37	70.2	90.5	1004
3.0 (183 kw)	2012.07-2015.10	7AT	R	L/R	SUV 4WD 642826		2350900L	Drive Shaft		27	30	44.97	79	841
3.0 (190 kw)	2012.07-2015.10	7AT	R	L/R	SUV 4WD 642826		2350900L	Drive Shaft		27	30	44.97	79	841
3.0 (195 kw)	2010.10-2012.08	7AT	F	L	SUV 4WD 642822		2050600L	Drive Shaft		30	37	70.2	90.5	665
	2010.10-2012.08	7AT	F	R	SUV 4WD 642822		2050610L	Drive Shaft		30	37	70.2	90.5	1004
GL400														
3.0 (245 kw)	2013.08-2015.10	7AT	R	L/R	SUV 4WD 276821	For vehicles without off-road suspension	2350900L	Drive Shaft		27	30	44.97	79	841
GL420														
4.0 (225 kw)	2006.01-2010.12	7AT	F	L	SUV 4WD 629912		2050600L	Drive Shaft		30	37	70.2	90.5	665
	2006.01-2010.12	7AT	F	R	SUV 4WD 629912		2050610L	Drive Shaft		30	37	70.2	90.5	1004
GL450														
4.0 (225 kw)	2009.06-2012.08	7AT	F	L	SUV 4WD 629912		2050600L	Drive Shaft		30	37	70.2	90.5	665
	2009.06-2012.08	7AT	F	R	SUV 4WD 629912		2050610L	Drive Shaft		30	37	70.2	90.5	1004
4.7 (250 kw)	2006.01-2012.08	7AT	F	L	SUV 4WD 273923		2050600L	Drive Shaft		30	37	70.2	90.5	665
	2006.01-2012.08	7AT	F	R	SUV 4WD 273923		2050610L	Drive Shaft		30	37	70.2	90.5	1004
GL500														
4.7 (320 kw)	2012.07-2015.10	7AT/9AT	R	L/R	SUV 4WD 278928		2350900L	Drive Shaft		27	30	44.97	79	841
5.5 (285 kw)	2006.01-2012.08	7AT	F	L	SUV 4WD 273963		2050600L	Drive Shaft		30	37	70.2	90.5	665
	2006.01-2012.08	7AT	F	R	SUV 4WD 273963		2050610L	Drive Shaft		30	37	70.2	90.5	1004
GL550														
5.5 (285 kw)	2006.07-2011.12	7AT	F	L	SUV 4WD 273963		2050600L	Drive Shaft		30	37	70.2	90.5	665
	2006.07-2011.12	7AT	F	R	SUV 4WD 273963		2050610L	Drive Shaft		30	37	70.2	90.5	1004
GLA180														
1.5 (80 kw)	2014.07-	7AT/6MT	F	L	SUV FWD 607951		2350670L	Drive Shaft		30	27	65.5	53.5	537
	2014.07-	7AT/6MT	F	R	SUV FWD 607951	Due to 2016.03 For SA code 452 For vehicles with increased ground clearance	2014700L	Drive Shaft		30	27	65.5	53.5	998
1.6 (90 kw)	2015.02-	AT/MT	F	L	SUV FWD 270910	Not for vehicles with increased ground clearance. Not for taxis	2350670L	Drive Shaft		30	27	65.5	53.5	537
	2015.02-	AT/MT	F	L	SUV FWD 270910	Not for vehicles with increased ground clearance. For taxis	2350670L	Drive Shaft		30	27	65.5	53.5	537
	2015.02-	AT/MT	F	L	SUV FWD 270910	For vehicles with increased ground clearance	2350670L	Drive Shaft		30	27	65.5	53.5	537
GLA200														
1.6 (115 kw)	2013.12-	7AT/6MT	F	L	SUV FWD 270910	Due to 2016.03 For SA code 452 For vehicles with increased ground clearance	2350670L	Drive Shaft		30	27	65.5	53.5	537
	2013.12-	7AT/6MT	F	R	SUV FWD 270910	Due to 2016.03 For SA code 452 For vehicles with increased ground clearance	2014700L	Drive Shaft		30	27	65.5	53.5	998
2.2 (100 kw)	2013.12-	AT	F	L	SUV 4WD 651930		2350670L	Drive Shaft		30	27	65.5	53.5	537
	2013.12-	AT	F	R	SUV 4WD 651930	With Intermediate Shaft	2014700L	Drive Shaft		30	27	65.5	53.5	998
	2013.12-	AT/MT	F	L	SUV FWD 651930		2350670L	Drive Shaft		30	27	65.5	53.5	537
	2013.12-	AT/MT	F	R	SUV FWD 651930	With Intermediate Shaft	2014700L	Drive Shaft		30	27	65.5	53.5	998
GLA220														
2.0 (135 kw)	2017.01-	7AT	F	L	SUV 4WD 270920		2350670L	Drive Shaft		30	27	65.5	53.5	537
	2017.01-	7AT	F	R	SUV 4WD 270920		2014700L	Drive Shaft		30	27	65.5	53.5	998
2.2 (120 kw)	2013.12-	7AT	F	R	SUV 4WD 651930	With Intermediate Shaft	2014700L	Drive Shaft		30	27	65.5	53.5	998
	2013.12-	AT	F	R	SUV FWD 651930	With Intermediate Shaft	2014700L	Drive Shaft		30	27	65.5	53.5	998
2.2 (125 kw)	2013.12-	7AT	F	L	SUV 4WD 651930		2350670L	Drive Shaft		30	27	65.5	53.5	537
	2013.12-	7AT	F	R	SUV 4WD 651930	With Intermediate Shaft	2014700L	Drive Shaft		30	27	65.5	53.5	998
	2013.12-	AT	F	R	SUV FWD 651930	With Intermediate Shaft	2014700L	Drive Shaft		30	27	65.5	53.5	998
2.2 (130 kw)	2015.07-	DCT	F	L	SUV 4WD 651930		2350670L	Drive Shaft		30	27	65.5	53.5	537
	2015.07-	DCT	F	R	SUV 4WD 651930	With Intermediate Shaft	2014700L	Drive Shaft		30	27	65.5	53.5	998
	2015.07-	DCT	F	R	SUV FWD 651930	With Intermediate Shaft	2014700L	Drive Shaft		30	27	65.5	53.5	998
GLA250														
2.0 (155 kw)	2013.12-	7AT	F	L	SUV 4WD 270920	Due to 2016.04 For vehicles with increased ground clearance For SA code 462	2350670L	Drive Shaft		30	27	65.5	53.5	537
	2013.12-	7AT	F	R	SUV 4WD 270920	Due to 2016.04 For vehicles with increased ground clearance For SA code 462	2014700L	Drive Shaft		30	27	65.5	53.5	998
	2013.12-	7AT/6MT	F	L	SUV FWD 270920	Due to 2016.04 For vehicles with increased ground clearance For SA code 462	2350670L	Drive Shaft		30	27	65.5	53.5	537
	2013.12-	MT/DCT	F	R	SUV FWD 270920	Due to 2016.04 For vehicles with increased ground clearance For SA code 462	2014700L	Drive Shaft		30	27	65.5	53.5	998
GLC200														
2.0 (120 kw)	2019.04-	9AT	F	L	SUV 4WD 654920	For left-hand drive vehicles; 8 balls	2036550L	Drive Shaft		30	27	71	56	526
	2019.04-	9AT	F	L	SUV 4WD 654920	6 balls	2037840L	Drive Shaft		30	27	71	56	524
	2019.04-	9AT	F	R	SUV 4WD 654920	For left-hand drive vehicles	2037420L	Drive Shaft		30	24	71	56	592
	2019.04-	9AT	F	R	SUV 4WD 654920	6balls,length2:54.5mm	2037420L	Drive Shaft		30	24	71	56	592
	2019.04-	9AT	F	R	SUV 4WD 654920	For left-hand drive vehicles; 8balls,length2:62mm	2037820L	Drive Shaft		30	27	71	56	556
	2019.04-	9AT	R	L/R	SUV 4WD 654920		2037430L	Drive Shaft		27	27		82	800
2.0 (145 kw)	2019.04-	9AT	F	L	SUV 4WD 264920	For left-hand drive vehicles; 8 balls	2036550L	Drive Shaft		30	27	71	56	526



	 YEAR	TRANSM.	F/R	L/R	BODY STYLE & DRIVE TYPE & ENGINE	REMARKS	GSP Ref.	 PRODUCT ABS	Technical Specifications				
									A	B	C	H	L
MERCEDES-BENZ GLC200													
2.0 (145 kw)													
	2019.04-	9AT	F	L	SUV 4WD 264920	6 balls	2037840L	Drive Shaft	30	27	71	56	524
	2019.04-	9AT	F	L	SUV 4WD 264920	For left-hand drive vehicles,6 balls	2037840L	Drive Shaft	30	27	71	56	524
	2019.04-	9AT	F	R	SUV 4WD 264920		2037820L	Drive Shaft	30	27	71	56	556
	2019.04-	9AT	R	L	SUV 4WD 264920		2037430L	Drive Shaft	27	27		82	800
	2019.04-	9AT	R	R	SUV 4WD 264920		2037410L	Drive Shaft	27	27		82	800
	2022.05-	9AT	F	L	SUV 4WD M 274.920		2037840L	Drive Shaft	30	27	71	56	524
	2022.05-	9AT	F	R	SUV 4WD M 274.920		2037820L	Drive Shaft	30	27	71	56	556
	2022.05-	9AT	R	L	SUV 4WD M 274.920		2037430L	Drive Shaft	27	27		82	800
	2022.05-	9AT	R	R	SUV 4WD M 274.920		2037410L	Drive Shaft	27	27		82	800
GLC220													
2.0 (143 kw)													
	2019.04-	9AT	F	L	SUV 4WD 654920	8 balls	2036550L	Drive Shaft	30	27	71	56	526
	2019.04-	9AT	F	L	SUV 4WD 654920	For left-hand drive vehicles,8 balls	2036550L	Drive Shaft	30	27	71	56	526
	2019.04-	9AT	F	L	SUV 4WD 654920	6 balls	2037840L	Drive Shaft	30	27	71	56	524
	2019.04-	9AT	F	R	SUV 4WD 654920		2037420L	Drive Shaft	30	24	71	56	592
	2019.04-	9AT	F	R	SUV 4WD 654920	For left-hand drive vehicles	2037420L	Drive Shaft	30	24	71	56	592
	2019.04-	9AT	F	R	SUV 4WD 654920	For SA code 430,For vehicles with off-road suspension,For left-hand drive vehicles	2037820L	Drive Shaft	30	27	71	56	556
	2019.04-	9AT	R	L/R	SUV 4WD 654920		2037430L	Drive Shaft	27	27		82	800
2.2 (120 kw)													
	2015.06-2019.04	9AT	F	L	SUV 4WD 651921	8 balls	2036550L	Drive Shaft	30	27	71	56	526
	2015.06-2019.04	9AT	F	L	SUV 4WD 651921	6 balls	2037840L	Drive Shaft	30	27	71	56	524
	2015.06-2019.04	9AT	F	R	SUV 4WD 651921	6 balls	2037420L	Drive Shaft	30	24	71	56	592
	2015.06-2019.04	9AT	F	R	SUV 4WD 651921	For SA code 430,For vehicles with off-road suspension	2037820L	Drive Shaft	30	27	71	56	556
	2015.06-2019.04	9AT	R	L	SUV 4WD 651921	Date from:2016.12,Chassis no. from:V000608	2037430L	Drive Shaft	27	27		82	800
	2015.06-2019.04	9AT	R	R	SUV 4WD 651921	Date from:2016.12,Chassis no. from:V000608 To Chassis V00283	2037410L	Drive Shaft	27	27		82	800
	2015.06-2019.04	9AT	R	R	SUV 4WD 651921	Date from:2017.02,Chassis no. from:V002283	2037430L	Drive Shaft	27	27		82	800
	2016.06-2019.04	9AT	F	L	SUV 4WD 651921	8 balls	2036550L	Drive Shaft	30	27	71	56	526
	2016.06-2019.04	9AT	F	L	SUV 4WD 651921	6 balls	2037840L	Drive Shaft	30	27	71	56	524
	2016.06-2019.04	9AT	F	R	SUV 4WD 651921		2037420L	Drive Shaft	30	24	71	56	592
	2016.06-2019.04	9AT	R	L/R	SUV 4WD 651921		2037430L	Drive Shaft	27	27		82	800
2.2 (125 kw)													
	2015.06-2019.04	6MT/9AT	F	R	SUV 4WD 651921	6 balls	2037420L	Drive Shaft	30	24	71	56	592
	2015.06-2019.04	9AT	F	L	SUV 4WD 651921	8 balls	2036550L	Drive Shaft	30	27	71	56	526
	2015.06-2019.04	9AT	F	L	SUV 4WD 651921	6 balls	2037840L	Drive Shaft	30	27	71	56	524
	2015.06-2019.04	9AT	F	R	SUV 4WD 651921	For SA code 430,For vehicles with off-road suspension	2037820L	Drive Shaft	30	27	71	56	556
	2015.06-2019.04	9AT	R	L	SUV 4WD 651921	Date from:2016.12,Chassis no. from:V000608	2037430L	Drive Shaft	27	27		82	800
	2015.06-2019.04	9AT	R	R	SUV 4WD 651921	Date from:2016.12,Chassis no. from:V000608 To Chassis V00283	2037410L	Drive Shaft	27	27		82	800
	2015.06-2019.04	9AT	R	R	SUV 4WD 651921	Date from:2017.02,Chassis no. from:V002283	2037430L	Drive Shaft	27	27		82	800
	2016.06-2019.04	9AT	F	L	SUV 4WD 651921	8 balls	2036550L	Drive Shaft	30	27	71	56	526
	2016.06-2019.04	9AT	F	L	SUV 4WD 651921	6 balls	2037840L	Drive Shaft	30	27	71	56	524
	2016.06-2019.04	9AT	F	R	SUV 4WD 651921		2037420L	Drive Shaft	30	24	71	56	592
	2016.06-2019.04	9AT	R	L/R	SUV 4WD 651921		2037430L	Drive Shaft	27	27		82	800
GLC250													
2.0 (155 kw)													
	2015.06-2019.04	6MT/9AT	F	R	SUV 4WD 274920		2037420L	Drive Shaft	30	24	71	56	592
	2015.06-2019.04	9AT	F	L	SUV 4WD 274920	8 balls	2036550L	Drive Shaft	30	27	71	56	526
	2015.06-2019.04	9AT	F	L	SUV 4WD 274920	6 balls	2037840L	Drive Shaft	30	27	71	56	524
	2015.06-2019.04	9AT	F	R	SUV 4WD 274920	For SA code 430,For vehicles with off-road suspension	2037820L	Drive Shaft	30	27	71	56	556
	2015.06-2019.04	9AT	R	L	SUV 4WD 274920	Date From:2016.10	2037430L	Drive Shaft	27	27		82	800
	2015.06-2019.04	9AT	R	R	SUV 4WD 274920	Date From:2016.10	2037410L	Drive Shaft	27	27		82	800
	2016.06-2019.04	9AT	F	L	SUV 4WD 274920	8 balls	2036550L	Drive Shaft	30	27	71	56	526
	2016.06-2019.04	9AT	F	L	SUV 4WD 274920	6 balls	2037840L	Drive Shaft	30	27	71	56	524
	2016.06-2019.04	9AT	F	R	SUV 4WD 274920		2037420L	Drive Shaft	30	24	71	56	592
	2016.06-2019.04	9AT	R	L	SUV 4WD 274920		2037430L	Drive Shaft	27	27		82	800
	2016.06-2019.04	9AT	R	R	SUV 4WD 274920		2037410L	Drive Shaft	27	27		82	800
2.2 (150 kw)													
	2015.06-2019.04	6MT/9AT	F	R	SUV 4WD 651921		2037420L	Drive Shaft	30	24	71	56	592
	2015.06-2019.04	9AT	F	L	SUV 4WD 651921	8 balls	2036550L	Drive Shaft	30	27	71	56	526
	2015.06-2019.04	9AT	F	L	SUV 4WD 651921	6 balls	2037840L	Drive Shaft	30	27	71	56	524
	2015.06-2019.04	9AT	F	R	SUV 4WD 651921	For SA code 430,For vehicles with off-road suspension	2037820L	Drive Shaft	30	27	71	56	556
	2016.06-2019.04	9AT	F	L	SUV 4WD 651921	8 balls	2036550L	Drive Shaft	30	27	71	56	526
	2016.06-2019.04	9AT	F	L	SUV 4WD 651921	6 balls	2037840L	Drive Shaft	30	27	71	56	524
	2016.06-2019.04	9AT	F	R	SUV 4WD 651921	For right-hand drive vehicles,8balls,length2:54.5mm	2037420L	Drive Shaft	30	24	71	56	592
	2016.06-2019.04	9AT	F	R	SUV 4WD 651921	For left-hand drive vehicles,8balls,length2:62mm	2037820L	Drive Shaft	30	27	71	56	556
	2016.06-2019.04	9AT	R	L	SUV 4WD 651921	length2:80mm	2037430L	Drive Shaft	27	27		82	800
GLC300													
2.0 (143 kw)													
	2020.05-	9AT	F	L	SUV 4WD 654920	8 balls	2036550L	Drive Shaft	30	27	71	56	526
	2020.05-	9AT	F	L	SUV 4WD 654920	6 balls	2037840L	Drive Shaft	30	27	71	56	524
	2020.05-	9AT	F	R	SUV 4WD 654920	For right-hand drive vehicles,8balls,length2:54.5mm	2037420L	Drive Shaft	30	24	71	56	592
	2020.05-	9AT	F	R	SUV 4WD 654920		2037820L	Drive Shaft	30	27	71	56	556





	 YEAR	TRANSM.	F/R	L/R	BODY STYLE & DRIVE TYPE & ENGINE	REMARKS	GSP Ref.	 PRODUCT ABS	Technical Specifications							
									A	B	C	H	L			
MERCEDES-BENZ GLC300																
2.0 (143 kw)	2020.05-	9AT	F	R	SUV 4WD 654920	For left-hand drive vehicles	2037820L	Drive Shaft		30	27	71	56	556		
2.0 (155 kw)	2019.11-	9AT	F	L	SUV 4WD 274920	8 balls	2036550L	Drive Shaft		30	27	71	56	526		
	2019.11-	9AT	F	L	SUV 4WD 274920	6 balls	2037840L	Drive Shaft		30	27	71	56	524		
	2019.11-	9AT	F	R	SUV 4WD 274920	For right-hand drive vehicles,6balls	2037420L	Drive Shaft		30	24	71	56	592		
	2019.11-	9AT	F	R	SUV 4WD 274920		2037820L	Drive Shaft		30	27	71	56	556		
	2019.11-	9AT	F	R	SUV 4WD 274920	For left-hand drive vehicles	2037820L	Drive Shaft		30	27	71	56	556		
	2019.11-	9AT	F	R	SUV 4WD 274920		2037820L	Drive Shaft		30	27	71	56	556		
2.0 (180 kw)	2015.07-2019.04	9AT	F	L	SUV 4WD 274920	8 balls	2036550L	Drive Shaft		30	27	71	56	526		
	2015.07-2019.04	9AT	F	L	SUV 4WD 274920	6 balls	2037840L	Drive Shaft		30	27	71	56	524		
	2015.07-2019.04	9AT	F	R	SUV 4WD 274920	6balls,length2:54.5mm	2037420L	Drive Shaft		30	24	71	56	592		
	2015.07-2019.04	9AT	F	R	SUV 4WD 274920	For SA code 432 For vehicles with off-road suspension,8balls,length2:62mm	2037820L	Drive Shaft		30	27	71	56	556		
	2015.07-2019.04	9AT	R	L	SUV 4WD 274920	Date From:2016.10	2037430L	Drive Shaft		27	27		82	800		
	2015.07-2019.04	9AT	R	R	SUV 4WD 274920	Date From:2016.10	2037410L	Drive Shaft		27	27		82	800		
	2016.06-2019.04	9AT	F	L	SUV 4WD 274920	8 balls	2036550L	Drive Shaft		30	27	71	56	526		
	2016.06-2019.04	9AT	F	L	SUV 4WD 274920	6 balls	2037840L	Drive Shaft		30	27	71	56	524		
	2016.06-2019.04	9AT	F	R	SUV 4WD 274920		2037420L	Drive Shaft		30	24	71	56	592		
	2016.06-2019.04	9AT	R	L	SUV 4WD 274920		2037430L	Drive Shaft		27	27		82	800		
	2016.06-2019.04	9AT	R	R	SUV 4WD 274920		2037410L	Drive Shaft		27	27		82	800		
	2019.04-	9AT	F	L	SUV 4WD 654920	For left-hand drive vehicles;8 balls	2036550L	Drive Shaft		30	27	71	56	526		
	2019.04-	9AT	F	L	SUV 4WD 654920	8 balls	2036550L	Drive Shaft		30	27	71	56	526		
	2019.04-	9AT	F	L	SUV 4WD 654920	6 balls	2037840L	Drive Shaft		30	27	71	56	524		
	2019.04-	9AT	F	R	SUV 4WD 654920	length2:54.5mm	2037420L	Drive Shaft		30	24	71	56	592		
	2019.04-	9AT	F	R	SUV 4WD 654920		2037820L	Drive Shaft		30	27	71	56	556		
	2019.04-	9AT	F	R	SUV 4WD 654920	For SA code:M014,length2:62mm	2037820L	Drive Shaft		30	27	71	56	556		
	2019.04-	9AT	R	L/R	SUV 4WD 654920	For left-hand drive vehicles	2037430L	Drive Shaft		27	27		82	800		
	2.0 (190 kw)	2019.04-	9AT	F	L	SUV 4WD 264920	8 balls	2036550L	Drive Shaft		30	27	71	56	526	
		2019.04-	9AT	F	L	SUV 4WD 264920	For left-hand drive vehicles;8 balls	2036550L	Drive Shaft		30	27	71	56	526	
2019.04-		9AT	F	L	SUV 4WD 264920	6 balls	2037840L	Drive Shaft		30	27	71	56	524		
2019.04-		9AT	F	R	SUV 4WD 264920	For Modelcode:253349	2037420L	Drive Shaft		30	24	71	56	592		
2019.04-		9AT	F	R	SUV 4WD 264920	For Modelcode:253384	2037820L	Drive Shaft		30	27	71	56	556		
2019.04-		9AT	F	R	SUV 4WD 264920	For left-hand drive vehicles	2037820L	Drive Shaft		30	27	71	56	556		
2019.04-		9AT	R	L	SUV 4WD 264920	For Modelcode:253349;For Modelcode:253384;For left-hand drive vehicles	2037430L	Drive Shaft		27	27		82	800		
2019.04-		9AT	R	L	SUV 4WD 264920	For Modelcode:253349;For Modelcode:253384;For left-hand drive vehicles	2037430L	Drive Shaft		27	27		82	800		
2019.04-		9AT	R	R	SUV 4WD 264920	For Modelcode:253349;For Modelcode:253384;For left-hand drive vehicles	2037410L	Drive Shaft		27	27		82	800		
2019.04-		9AT	R	R	SUV 4WD 264920	For Modelcode:253349;For Modelcode:253384;For left-hand drive vehicles	2037410L	Drive Shaft		27	27		82	800		
2019.11-		9AT	F	L	SUV 4WD 264920	8 balls	2036550L	Drive Shaft		30	27	71	56	526		
2019.11-		9AT	F	L	SUV 4WD 264920	6 balls	2037840L	Drive Shaft		30	27	71	56	524		
2019.11-		9AT	F	R	SUV 4WD 264920		2037820L	Drive Shaft		30	27	71	56	556		
2019.11-		9AT	R	L	SUV 4WD 264920	For left-hand drive vehicles	2037430L	Drive Shaft		27	27		82	800		
2019.11-		9AT	R	R	SUV 4WD 264920	For left-hand drive vehicles	2037410L	Drive Shaft		27	27		82	800		
2022.05-		9AT	F	L	SUV 4WD M 274.920		2037840L	Drive Shaft		30	27	71	56	524		
2022.05-		9AT	F	R	SUV 4WD M 274.920	For Modelcode:253349,6balls	2037420L	Drive Shaft		30	24	71	56	592		
2022.05-		9AT	F	R	SUV 4WD M 274.920	For Modelcode:253384	2037820L	Drive Shaft		30	27	71	56	556		
2022.05-		9AT	F	R	SUV 4WD M 274.920		2037820L	Drive Shaft		30	27	71	56	556		
2022.05-		9AT	R	L	SUV 4WD M 274.920	For Modelcode:253349;For Modelcode:253384;For left-hand drive vehicles	2037430L	Drive Shaft		27	27		82	800		
2022.05-		9AT	R	L	SUV 4WD M 274.920	For Modelcode:253349;For Modelcode:253384;For left-hand drive vehicles	2037430L	Drive Shaft		27	27		82	800		
2022.05-		9AT	R	R	SUV 4WD M 274.920	For Modelcode:253349;For Modelcode:253384;For left-hand drive vehicles	2037410L	Drive Shaft		27	27		82	800		
2022.05-		9AT	R	R	SUV 4WD M 274.920	For Modelcode:253349;For Modelcode:253384;For left-hand drive vehicles	2037410L	Drive Shaft		27	27		82	800		
GLC350																
2.0 (155 kw)		2016.01-2019.04	7AT	F	L	SUV 4WD 274920	8 balls	2036550L	Drive Shaft		30	27	71	56	526	
		2016.01-2019.04	7AT	F	L	SUV 4WD 274920	6 balls	2037840L	Drive Shaft		30	27	71	56	524	
		2016.01-2019.04	7AT	F	R	SUV 4WD 274920		2037820L	Drive Shaft		30	27	71	56	556	
		2016.10-2019.04	7AT	F	L	SUV 4WD 274920	8 balls	2036550L	Drive Shaft		30	27	71	56	526	
	2016.10-2019.04	7AT	F	L	SUV 4WD 274920	6 balls	2037840L	Drive Shaft		30	27	71	56	524		
	2016.10-2019.04	7AT	F	R	SUV 4WD 274920	6 balls,length2:54.5mm	2037420L	Drive Shaft		30	24	71	56	592		
	2016.10-2019.04	7AT	F	R	SUV 4WD 274920	For left-hand drive vehicles,length2:62mm	2037820L	Drive Shaft		30	27	71	56	556		
3.0 (190 kw)	2016.10-2019.04	9AT	F	L	SUV 4WD 642873	8 balls	2036550L	Drive Shaft		30	27	71	56	526		
	2016.10-2019.04	9AT	F	L	SUV 4WD 642873	6 balls	2037840L	Drive Shaft		30	27	71	56	524		
	2016.10-2019.04	9AT	F	R	SUV 4WD 642873	6balls,length2:54.5mm	2037420L	Drive Shaft		30	24	71	56	592		
	2016.10-2019.04	9AT	F	R	SUV 4WD 642873	length2:62mm	2037820L	Drive Shaft		30	27	71	56	556		
	2016.10-2019.04	9AT	F	R	SUV 4WD 642873	For SA code:M014,8balls,length2:62mm	2037820L	Drive Shaft		30	27	71	56	556		
GLC400																
2.9 (243 kw)	2019.08-	9AT	F	L	SUV 4WD 656929	8 balls	2036550L	Drive Shaft		30	27	71	56	526		
	2019.08-	9AT	F	L	SUV 4WD 656929	6 balls	2037840L	Drive Shaft		30	27	71	56	524		
	2019.08-	9AT	F	R	SUV 4WD 656929	For right-hand drive vehicles,6balls,length2:54.5mm	2037420L	Drive Shaft		30	24	71	56	592		
	2019.08-	9AT	F	R	SUV 4WD 656929	8balls,length2:62mm	2037820L	Drive Shaft		30	27	71	56	556		



		TRANSM.	F/R	L/R	BODY STYLE & DRIVE TYPE & ENGINE	REMARKS	GSP Ref.		ABS	Technical Specifications				
										A	B	C	H	L
MERCEDES-BENZ GLC400														
2.9 (243 kw)	2019.08-	9AT	F	R	SUV 4WD 656929		2037820L	Drive Shaft		30	27	71	56	556
GLC43 AMG														
3.0 (270 kw)	2015.07-2019.08	9AT	F	L	SUV 4WD 276823	8 balls	2036550L	Drive Shaft		30	27	71	56	526
	2015.07-2019.08	9AT	F	L	SUV 4WD 276823	6 balls	2037840L	Drive Shaft		30	27	71	56	524
	2015.07-2019.08	9AT	F	R	SUV 4WD 276823		2037420L	Drive Shaft		30	24	71	56	592
	2016.10-2019.08	9AT	F	L	SUV 4WD 276823	8 balls	2036550L	Drive Shaft		30	27	71	56	526
	2016.10-2019.08	9AT	F	L	SUV 4WD 276823	6 balls	2037840L	Drive Shaft		30	27	71	56	524
	2016.10-2019.08	9AT	F	R	SUV 4WD 276823		2037420L	Drive Shaft		30	24	71	56	592
3.0 (287 kw)	2019.08-	9AT	F	L	SUV 4WD 276823	8 balls	2036550L	Drive Shaft		30	27	71	56	526
	2019.08-	9AT	F	L	SUV 4WD 276823	6 balls	2037840L	Drive Shaft		30	27	71	56	524
	2019.08-	9AT	F	R	SUV 4WD 276823		2037420L	Drive Shaft		30	24	71	56	592
GLE250														
2.2 (150 kw)	2015.04-2018.10	7AT/9AT	R	L/R	SUV 4WD 651960	For SA code:550/554.For vehicles with towbar	2350900L	Drive Shaft		27	30	44.97	79	841
	2015.04-2018.10	7AT/9AT	R	L/R	SUV RWD 651960	For SA code:550/554.For vehicles with towbar	2350900L	Drive Shaft		27	30	44.97	79	841
GLE350														
3.0 (183 kw)	2015.04-2018.10	9AT	R	L/R	SUV 4WD 642826	For SA code:806/807/808/809/800	2350900L	Drive Shaft		27	30	44.97	79	841
3.0 (190 kw)	2015.04-2018.10	7AT	R	L/R	SUV 4WD 642826		2350900L	Drive Shaft		27	30	44.97	79	841
GLE400														
3.0 (245 kw)	2015.04-2018.10	7AT	R	L/R	SUV 4WD 276821/276825		2350900L	Drive Shaft		27	30	44.97	79	841
GLE43 AMG														
3.0 (270 kw)	2016.05-2018.10	9AT	R	L/R	SUV 4WD 276821		2350900L	Drive Shaft		27	30	44.97	79	841
GLE450 AMG														
3.0 (270 kw)	2015.10-2018.10	9AT	R	L/R	SUV 4WD 276821		2350900L	Drive Shaft		27	30	44.97	79	841
GLE500														
3.0 (245 kw)	2015.04-2018.10	7AT/9AT	R	L/R	SUV 4WD 276821		2350900L	Drive Shaft		27	30	44.97	79	841
4.7 (320 kw)	2015.04-2018.10	7AT	R	L/R	SUV 4WD 278928		2350900L	Drive Shaft		27	30	44.97	79	841
GLK200														
2.0 (135 kw)	2013.08-2015.12	6MT	R	L/R	SUV RWD 274920		2351190L	Drive Shaft	48NS	27	27	45	79	803
2.2 (100 kw)	2013.12-2015.06	6MT/7AT	R	L/R	SUV RWD 651916		2351190L	Drive Shaft	48NS	27	27	45	79	803
2.2 (105 kw)	2010.07-2015.06	6MT/7AT	R	L/R	SUV RWD 651913/651916		2351190L	Drive Shaft	48NS	27	27	45	79	803
GLK220														
2.2 (120 kw)	2008.06-2015.06	6MT/7AT	R	L/R	SUV RWD 651916		2351190L	Drive Shaft	48NS	27	27	45	79	803
2.2 (125 kw)	2008.06-2015.06	6MT/7AT	R	L/R	SUV RWD 651916		2351190L	Drive Shaft	48NS	27	27	45	79	803
GLK250														
2.0 (155 kw)	2013.08-2015.06	7AT/6MT	R	L/R	SUV RWD 274920		2351190L	Drive Shaft	48NS	27	27	45	79	803
GLK350														
3.0 (195 kw)	2012.07-2015.06	7AT	R	L/R	SUV 4WD 642835		2351190L	Drive Shaft	48NS	27	27	45	79	803
3.5 (200 kw)	2009.04-2015.06	7AT	R	L/R	SUV RWD 272991		2351190L	Drive Shaft	48NS	27	27	45	79	803
GLS350														
3.0 (190 kw)	2015.11-2019.04	9AT	R	L/R	SUV 4WD 642826	For SA code:056/806/807	2350900L	Drive Shaft		27	30	44.97	79	841
GLS400														
3.0 (245 kw)	2015.11-2019.04	9AT	R	L/R	SUV 4WD 276821	For SA code:056/806/807	2350900L	Drive Shaft		27	30	44.97	79	841
GLS500														
4.7 (335 kw)	2015.11-2019.04	9AT	R	L/R	SUV 4WD 278928	For SA code:056/806/807	2350900L	Drive Shaft		27	30	44.97	79	841
MARCO POLO 160														
1.6 (65 kw)	2015.03-	6MT	F	L	Bus FWD 622951		2031390L	Drive Shaft		30	39	66	98.5	699
	2015.03-	6MT	F	R	Bus FWD 622951		2031380L	Drive Shaft		30	39	66	98.5	1023
MARCO POLO 170														
1.7 (75 kw)	2020.06-	6MT	F	L	Bus FWD 622851		2031390L	Drive Shaft		30	39	66	98.5	699
	2020.06-	6MT	F	R	Bus FWD 622851		2031380L	Drive Shaft		30	39	66	98.5	1023
MARCO POLO 180														
1.6 (84 kw)	2015.03-	6MT	F	L	Bus FWD 622951		2031390L	Drive Shaft		30	39	66	98.5	699
	2015.03-	6MT	F	R	Bus FWD 622951		2031380L	Drive Shaft		30	39	66	98.5	1023
MARCO POLO 200														
1.7 (100 kw)	2020.06-	6MT	F	L	Bus FWD 622851		2031390L	Drive Shaft		30	39	66	98.5	699
	2020.06-	6MT	F	R	Bus FWD 622851		2031380L	Drive Shaft		30	39	66	98.5	1023
ML250														
2.2 (150 kw)	2011.06-2015.02	7AT	R	L/R	SUV 4WD 651960	For vehicles with towbar	2350900L	Drive Shaft		27	30	44.97	79	841
ML280														
3.0 (140 kw)	2005.07-2009.07	7AT	F	L	SUV 4WD 642940		2050600L	Drive Shaft		30	37	70.2	90.5	665
	2005.07-2009.07	7AT	F	R	SUV 4WD 642940		2050610L	Drive Shaft		30	37	70.2	90.5	1004
ML300														
3.0 (140 kw)	2009.06-2011.12	7AT	F	L	SUV 4WD 642940		2050600L	Drive Shaft		30	37	70.2	90.5	665
	2009.06-2011.12	7AT	F	R	SUV 4WD 642940		2050610L	Drive Shaft		30	37	70.2	90.5	1004
3.0 (150 kw)	2009.06-2011.12	7AT	F	L	SUV 4WD 642820		2050600L	Drive Shaft		30	37	70.2	90.5	665



		TRANSM.	F/R	L/R	BODY STYLE & DRIVE TYPE & ENGINE	REMARKS	GSP Ref.		ABS	Technical Specifications				
										A	B	C	H	L
MERCEDES-BENZ ML300														
3.0 (150 kw)	2009.06-2011.12	7AT	F	R	SUV 4WD 642820		2050610L	Drive Shaft		30	37	70.2	90.5	1004
3.0 (170 kw)	2008.08-2011.12	7AT	F	L	SUV 4WD 272945		2050600L	Drive Shaft		30	37	70.2	90.5	665
	2008.08-2011.12	7AT	F	R	SUV 4WD 272945		2050610L	Drive Shaft		30	37	70.2	90.5	1004
ML320														
3.0 (155 kw)	2005.07-2011.07	7AT	F	L	SUV 4WD 642820/642940		2050600L	Drive Shaft		30	37	70.2	90.5	665
	2005.07-2011.07	7AT	F	R	SUV 4WD 642820/642940		2050610L	Drive Shaft		30	37	70.2	90.5	1004
3.0 (165 kw)	2005.07-2011.07	7AT	F	L	SUV 4WD 642940		2050600L	Drive Shaft		30	37	70.2	90.5	665
	2005.07-2011.07	7AT	F	R	SUV 4WD 642940		2050610L	Drive Shaft		30	37	70.2	90.5	1004
ML350														
3.0 (155 kw)	2009.09-2012.06	CVT/7AT	F	L	SUV 4WD 642820		2050600L	Drive Shaft		30	37	70.2	90.5	665
	2009.09-2012.06	CVT/7AT	F	R	SUV 4WD 642820		2050610L	Drive Shaft		30	37	70.2	90.5	1004
3.0 (165 kw)	2009.06-2012.11	7AT	F	L	SUV 4WD 642940		2050600L	Drive Shaft		30	37	70.2	90.5	665
	2009.06-2012.11	7AT	F	R	SUV 4WD 642940		2050610L	Drive Shaft		30	37	70.2	90.5	1004
3.0 (170 kw)	2009.06-2011.12	7AT	F	L	SUV 4WD 642820		2050600L	Drive Shaft		30	37	70.2	90.5	665
	2009.06-2011.12	7AT	F	R	SUV 4WD 642820		2050610L	Drive Shaft		30	37	70.2	90.5	1004
3.0 (190 kw)	2011.06-2015.02	7AT	R	L/R	SUV 4WD 642826		2350900L	Drive Shaft		27	30	44.97	79	841
3.5 (200 kw)	2005.02-2011.12	7AT	F	L	SUV 4WD 272967		2050600L	Drive Shaft		30	37	70.2	90.5	665
	2005.02-2011.12	7AT	F	R	SUV 4WD 272967		2050610L	Drive Shaft		30	37	70.2	90.5	1004
ML400														
3.0 (245 kw)	2013.08-2015.02	7AT/9AT	R	R	SUV 4WD 276821/276825		2350900L	Drive Shaft		27	30	44.97	79	841
ML420														
4.0 (225 kw)	2006.02-2009.09	7AT	F	L	SUV 4WD 629912		2050600L	Drive Shaft		30	37	70.2	90.5	665
	2006.02-2009.09	7AT	F	R	SUV 4WD 629912		2050610L	Drive Shaft		30	37	70.2	90.5	1004
ML450														
4.0 (225 kw)	2009.06-2011.12	7AT	F	L	SUV 4WD 629912		2050600L	Drive Shaft		30	37	70.2	90.5	665
	2009.06-2011.12	7AT	F	R	SUV 4WD 629912		2050610L	Drive Shaft		30	37	70.2	90.5	1004
ML500														
4.7 (300 kw)	2012.02-2015.02	7AT/9AT	R	L/R	SUV 4WD 278928		2350900L	Drive Shaft		27	30	44.97	79	841
5.0 (225 kw)	2005.08-2007.12	7AT	F	L	SUV 4WD 113964		2050600L	Drive Shaft		30	37	70.2	90.5	665
	2005.08-2007.12	7AT	F	R	SUV 4WD 113964		2050610L	Drive Shaft		30	37	70.2	90.5	1004
5.5 (285 kw)	2007.04-2012.06	7AT	F	L	SUV 4WD 273963		2050600L	Drive Shaft		30	37	70.2	90.5	665
	2007.04-2012.06	7AT	F	R	SUV 4WD 273963		2050610L	Drive Shaft		30	37	70.2	90.5	1004
ML550														
4.7 (300 kw)	2012.01-2015.02	7AT	R	L/R	SUV 4WD 278928		2350900L	Drive Shaft		27	30	44.97	79	841
ML63 AMG														
6.2 (375 kw)	2005.12-2011.12	7AT	F	L	SUV 4WD 156980		2050600L	Drive Shaft		30	37	70.2	90.5	665
	2005.12-2011.12	7AT	F	R	SUV 4WD 156980		2050610L	Drive Shaft		30	37	70.2	90.5	1004
S280														
3.0 (170 kw)	2006.08-2013.07	7AT	R	L/R	Saloon RWD 272946		2351190L	Drive Shaft	48NS	27	27	45	79	803
S300														
3.0 (170 kw)	2006.01-2013.07	7AT	R	L/R	Saloon RWD 272946		2351190L	Drive Shaft	48NS	27	27	45	79	803
S320														
3.0 (155 kw)	2006.06-2010.12	7AT	R	L/R	Saloon 4WD 642932		2351190L	Drive Shaft	48NS	27	27	45	79	803
3.0 (173 kw)	2006.06-2012.12	7AT	R	L/R	Saloon 4WD 642932		2351190L	Drive Shaft	48NS	27	27	45	79	803
S350														
3.0 (155 kw)	2009.01-2010.12	7AT	R	L/R	Saloon 4WD 642932		2351190L	Drive Shaft	48NS	27	27	45	79	803
3.0 (173 kw)	2009.06-2013.07	7AT	R	L/R	Saloon 4WD 642932		2351190L	Drive Shaft	48NS	27	27	45	79	803
3.0 (190 kw)	2010.06-2013.07	7AT	R	L/R	Saloon 4WD 642868		2351190L	Drive Shaft	48NS	27	27	45	79	803
3.5 (200 kw)	2005.09-2013.07	7AT	R	L/R	Saloon RWD 272965		2351190L	Drive Shaft	48NS	27	27	45	79	803
	2006.09-2013.07	7AT	R	L/R	Saloon 4WD 272975		2351190L	Drive Shaft	48NS	27	27	45	79	803
3.5 (225 kw)	2011.01-2013.07	7AT	R	L/R	Saloon 4WD 276950		2351190L	Drive Shaft	48NS	27	27	45	79	803
	2011.01-2013.07	7AT	R	L/R	Saloon RWD 276950		2351190L	Drive Shaft	48NS	27	27	45	79	803
S400														
3.5 (205 kw)	2008.11-2013.12	7AT	R	L/R	Saloon RWD 272974	Date to:2010.03,Chassis no. to:A349099	2351190L	Drive Shaft	48NS	27	27	45	79	803
S450														
4.7 (250 kw)	2005.12-2013.07	7AT	R	L/R	Saloon 4WD 273924		2351190L	Drive Shaft	48NS	27	27	45	79	803
S500														
4.7 (320 kw)	2011.01-2013.07	7AT	R	L/R	Saloon 4WD 278932		2351190L	Drive Shaft	48NS	27	27	45	79	803
5.5 (285 kw)	2006.06-2013.07	7AT	R	L/R	Saloon 4WD 273968		2351190L	Drive Shaft	48NS	27	27	45	79	803
SL350														
3.5 (225 kw)	2011.12-	7AT	R	L/R	Cabriolet RWD 276954		2351190L	Drive Shaft	48NS	27	27	45	79	803
SL400														
3.0 (245 kw)	2014.04-	7AT	R	L/R	Cabriolet RWD 276825		2351190L	Drive Shaft	48NS	27	27	45	79	803
3.0 (270 kw)	2016.01-	7AT	R	L/R	Cabriolet RWD 276825		2351190L	Drive Shaft	48NS	27	27	45	79	803



		TRANSM.	F/R	L/R	BODY STYLE & DRIVE TYPE & ENGINE	REMARKS	GSP Ref.		Technical Specifications					
									ABS	A	B	C	H	L
MERCEDES-BENZ														
SL63 AMG														
5.5 (395 kw)	2012.01-	7AT	R	L/R	Cabriolet RWD 157983		2351190L	Drive Shaft	48NS	27	27	45	79	803
5.5 (415 kw)	2012.01-	7AT	R	L/R	Cabriolet RWD 157983		2351190L	Drive Shaft	48NS	27	27	45	79	803
5.5 (420 kw)	2018.07-	7AT	R	L/R	Cabriolet RWD 157983		2351190L	Drive Shaft	48NS	27	27	45	79	803
5.5 (430 kw)	2014.04-	7AT	R	L/R	Cabriolet RWD 157983		2351190L	Drive Shaft	48NS	27	27	45	79	803
Vito 109														
1.6 (65 kw)	2014.09-	6MT	F	L	Van FWD 622951		2031390L	Drive Shaft		30	39	66	98.5	699
	2014.09-	6MT	F	R	Van FWD 622951		2031380L	Drive Shaft		30	39	66	98.5	1023
	2014.10-	6MT	F	L	Bus FWD 622951		2031390L	Drive Shaft		30	39	66	98.5	699
	2014.10-	6MT	F	R	Bus FWD 622951		2031380L	Drive Shaft		30	39	66	98.5	1023
Vito 110														
1.7 (75 kw)	2019.09-	6MT	F	L	Bus FWD 622851		2031390L	Drive Shaft		30	39	66	98.5	699
	2019.09-	6MT	F	R	Bus FWD 622851		2031380L	Drive Shaft		30	39	66	98.5	1023
	2019.09-	6MT	F	L	Van FWD 622851		2031390L	Drive Shaft		30	39	66	98.5	699
	2019.09-	6MT	F	R	Van FWD 622851		2031380L	Drive Shaft		30	39	66	98.5	1023
Vito 111														
1.6 (84 kw)	2014.09-	6MT	F	L	Van FWD 622951		2031390L	Drive Shaft		30	39	66	98.5	699
	2014.09-	6MT	F	R	Van FWD 622951		2031380L	Drive Shaft		30	39	66	98.5	1023
	2014.10-	6MT	F	L	Bus FWD 622951		2031390L	Drive Shaft		30	39	66	98.5	699
	2014.10-	6MT	F	R	Bus FWD 622951		2031380L	Drive Shaft		30	39	66	98.5	1023
Vito 114														
1.7 (100 kw)	2019.09-	6MT	F	L	Bus FWD 622851		2031390L	Drive Shaft		30	39	66	98.5	699
	2019.09-	6MT	F	R	Bus FWD 622851		2031380L	Drive Shaft		30	39	66	98.5	1023
	2019.09-	6MT	F	L	Van FWD 622851		2031390L	Drive Shaft		30	39	66	98.5	699
	2019.09-	6MT	F	R	Van FWD 622851		2031380L	Drive Shaft		30	39	66	98.5	1023
MINI														
Mini Clubman														
1.5 (75 kw)	2015.11-	6AT	F	L	Estate FWD B38A15A		2037120L	Drive Shaft		31	26	56		541
	2015.11-	6AT	F	R	Estate FWD B38A15A		2037130L	Drive Shaft		31	26	56		905
	2015.11-	6MT	F	L	Estate FWD B38A15A	Chassis number:LU91/LU92	2026310L	Drive Shaft		31	34	56		563
	2015.11-	6MT	F	R	Estate FWD B38A15A	Chassis number:LU91/LU92	2026320L	Drive Shaft		31	34	56		920
1.5 (85 kw)	2015.11-	6AT	F	L	Estate FWD B37C15A		2037120L	Drive Shaft		31	26	56		541
	2015.11-	6AT	F	R	Estate FWD B37C15A		2037130L	Drive Shaft		31	26	56		905
1.5 (100 kw)	2015.07-	6AT	F	L	Estate FWD B36A15A/B38A15A		2037120L	Drive Shaft		31	26	56		541
	2015.07-	6AT	F	R	Estate FWD B36A15A/B38A15A		2037130L	Drive Shaft		31	26	56		905
	2015.07-	6MT	F	L	Estate FWD B36A15A/B38A15A	For Engine Code:B38A15A;Chassis number:J3011022;For Engine Code:B38A15A	2026310L	Drive Shaft		31	34	56		563
	2015.07-	6MT	F	R	Estate FWD B36A15A/B38A15A	For Engine Code:B38A15A;Chassis number:J3011022;For Engine Code:B38A15A	2026320L	Drive Shaft		31	34	56		920
2.0 (100 kw)	2014.12-	8AT	F	L	Estate FWD B47C20A/B47C20B	For Engine Code:B47C20A;Diameter:25mm	2021770L	Drive Shaft		31	28	56		538
2.0 (110 kw)	2015.07-	8AT	F	L	Estate FWD B47C20A/B47C20B	For Engine Code:B47C20A	2021770L	Drive Shaft		31	28	56		538
2.0 (120 kw)	2014.11-	8AT	F	L	Estate FWD B46A20A/B48A20A/B48A20F	Diameter:25mm	2021770L	Drive Shaft		31	28	56		538
	2015.02-	8AT	F	L	Estate FWD B47C20A/B47C20B	For Engine Code:B47C20A;Diameter:25mm	2021770L	Drive Shaft		31	28	56		538
	2015.04-	8AT	F	L	Estate 4WD B47C20A/B47C20B	For Engine Code:B47C20A;Diameter:25mm	2021770L	Drive Shaft		31	28	56		538
	2015.04-	8AT	F	R	Estate 4WD B47C20A/B47C20B	For Engine Code:B47C20A	2026330L	Drive Shaft		31	35	56		499
	2015.04-	8AT	R	L/R	Estate 4WD B47C20A/B47C20B		2021760L	Drive Shaft		31	27	56		731
	2015.04-	8AT	F	L	Estate 4WD B48A20A	Diameter:25mm	2021770L	Drive Shaft		31	28	56		538
	2015.04-	8AT/6MT	F	R	Estate 4WD B48A20A		2026330L	Drive Shaft		31	35	56		499
	2015.04-	8AT/6MT	R	L/R	Estate 4WD B48A20A		2021760L	Drive Shaft		31	27	56		731
2.0 (131 kw)	2020.11-	8AT	R	L/R	Estate 4WD B48A20F		2021760L	Drive Shaft		31	27	56		731
2.0 (140 kw)	2015.11-	8AT	F	L	Estate FWD B47C20A/B47C20B	For Engine Code:B47C20A;Diameter:25mm	2021770L	Drive Shaft		31	28	56		538
	2016.01-	8AT	F	L	Estate 4WD B47C20A/B47C20B	For Engine Code:B47C20A;Diameter:25mm	2021770L	Drive Shaft		31	28	56		538
	2016.01-	8AT	F	R	Estate 4WD B47C20A/B47C20B	For Engine Code:B47C20A	2026330L	Drive Shaft		31	35	56		499
	2016.01-	8AT	R	L/R	Estate 4WD B47C20A/B47C20B		2021760L	Drive Shaft		31	27	56		731
2.0 (141 kw)	2014.11-	8AT	F	L	Estate FWD B46A20A/B48A20A/B48A20F		2021770L	Drive Shaft		31	28	56		538
	2016.01-	8AT	F	L	Estate 4WD B48A20A	Diameter:25mm	2021770L	Drive Shaft		31	28	56		538
	2016.01-	8AT/6MT	F	R	Estate 4WD B48A20A		2026330L	Drive Shaft		31	35	56		499
	2016.01-	8AT/6MT	R	L/R	Estate 4WD B48A20A		2021760L	Drive Shaft		31	27	56		731
2.0 (155 kw)	2014.11-	8AT	F	L	Estate 4WD B48A20A	Diameter:25mm	2021770L	Drive Shaft		31	28	56		538
	2014.11-	8AT/6MT	F	R	Estate 4WD B48A20A		2026330L	Drive Shaft		31	35	56		499
	2014.11-	8AT/6MT	R	L/R	Estate 4WD B48A20A		2021760L	Drive Shaft		31	27	56		731
	2014.11-	8AT	F	L	Estate FWD B46A20A/B48A20A/B48A20F	Diameter:25mm	2021770L	Drive Shaft		31	28	56		538
2.0 (170 kw)	2015.11-2019.06	8AT	F	L	Estate 4WD B48A20B	Diameter:25mm	2021770L	Drive Shaft		31	28	56		538
	2015.11-2019.06	8AT/6MT	F	R	Estate 4WD B48A20B		2026330L	Drive Shaft		31	35	56		499
	2015.11-2019.06	8AT/6MT	R	L/R	Estate 4WD B48A20B		2021760L	Drive Shaft		31	27	56		731
2.0 (225 kw)	2019.07-	8AT	R	L/R	Estate 4WD B48A20E		2021760L	Drive Shaft		31	27	56		731





	 YEAR	TRANSM.	F/R	L/R	BODY STYLE & DRIVE TYPE & ENGINE	REMARKS	GSP Ref.	 PRODUCT ABS	Technical Specifications						
									A	B	C	H	L		
MINI															
Mini Cooper															
1.5 (85 kw)	2013.12-	6AT	F	L	Hatchback FWD B37C15A		2023820L	Drive Shaft	31	26	56		500		
	2013.12-	6AT	F	R	Hatchback FWD B37C15A		2023800L	Drive Shaft	31	26	56		868		
	2015.11-	6AT	F	L	Cabriolet FWD B37C15A		2023820L	Drive Shaft	31	26	56		500		
	2015.11-	6AT	F	R	Cabriolet FWD B37C15A		2023800L	Drive Shaft	31	26	56		868		
1.5 (100 kw)	2013.12-	6AT	F	L	Hatchback FWD B38A15A		2023820L	Drive Shaft	31	26	56		500		
	2013.12-	6AT	F	R	Hatchback FWD B38A15A		2023800L	Drive Shaft	31	26	56		868		
	2013.12-	6MT	F	L	Hatchback FWD B38A15A		2023810L	Drive Shaft	31	34	56		527		
	2013.12-	6MT	F	R	Hatchback FWD B38A15A		2021740L	Drive Shaft	31	34	56		884		
	2015.11-	6AT	F	L	Cabriolet FWD B38A15A		2023820L	Drive Shaft	31	26	56		500		
	2015.11-	6AT	F	R	Cabriolet FWD B38A15A		2023800L	Drive Shaft	31	26	56		868		
	2015.11-	6MT	F	L	Cabriolet FWD B38A15A		2023810L	Drive Shaft	31	34	56		527		
	2015.11-	6MT	F	R	Cabriolet FWD B38A15A		2021740L	Drive Shaft	31	34	56		884		
Mini Countryman															
1.5 (75 kw)	2017.07-	6AT	F	L	Estate FWD B38A15A		2037120L	Drive Shaft	31	26	56		541		
	2017.07-	6AT	F	R	Estate FWD B38A15A		2037130L	Drive Shaft	31	26	56		905		
	2017.07-	6MT	F	R	Estate FWD B38A15A		2026320L	Drive Shaft	31	34	56		920		
1.5 (92 kw)	2020.07-	6AT	F	L	Estate 4WD B38A15A		2037120L	Drive Shaft	31	26	56		541		
	2020.07-	6AT	F	R	Estate 4WD B38A15A		2037130L	Drive Shaft	31	26	56		905		
1.5 (100 kw)	2016.10-	8AT/6MT	R	L/R	Estate 4WD B38A15A/B38A15F		2021760L	Drive Shaft	31	27	56		731		
	2016.10-	6AT	F	L	Estate FWD B38A15A/B38A15A/B38A15F		2037120L	Drive Shaft	31	26	56		541		
	2016.10-	6AT	F	R	Estate FWD B38A15A/B38A15A/B38A15F		2037130L	Drive Shaft	31	26	56		905		
	2016.10-	6MT	F	R	Estate FWD B38A15A/B38A15A/B38A15F		2026320L	Drive Shaft	31	34	56		920		
	2017.01-	6AT	F	L	Estate 4WD B38A15A		2037120L	Drive Shaft	31	26	56		541		
	2017.01-	6AT	F	R	Estate 4WD B38A15A		2037130L	Drive Shaft	31	26	56		905		
2.0 (100 kw)	2016.10-	8AT	F	L	Estate 4WD B47C20A	Diameter:25mm	2021770L	Drive Shaft	31	28	56		538		
	2016.10-	8AT/6MT	F	R	Estate 4WD B47C20A		2026330L	Drive Shaft	31	35	56		499		
	2016.10-	8AT/6MT	R	L/R	Estate 4WD B47C20A		2021760L	Drive Shaft	31	27	56		731		
	2016.10-	8AT	F	L	Estate FWD B47C20A	Diameter:25mm	2021770L	Drive Shaft	31	28	56		538		
2.0 (110 kw)	2016.10-	6MT	F	R	Estate 4WD B47C20A/B47C20B	Date To:2020.06	2026330L	Drive Shaft	31	35	56		499		
	2016.10-	8AT	F	L	Estate 4WD B47C20A/B47C20B	For Engine Code:B47C20A,Diameter:25mm	2021770L	Drive Shaft	31	28	56		538		
	2016.10-	8AT	F	R	Estate 4WD B47C20A/B47C20B	Date From:2020.07 For Engine Code:B47C20A	2026330L	Drive Shaft	31	35	56		499		
	2016.10-	8AT/6MT	R	L/R	Estate 4WD B47C20A/B47C20B		2021760L	Drive Shaft	31	27	56		731		
	2016.10-	8AT	F	L	Estate FWD B47C20A/B47C20B	For Engine Code:B47C20A	2021770L	Drive Shaft	31	28	56		538		
2.0 (120 kw)	2016.10-	8AT	F	L	Estate 4WD B46A20A/B48A20A	Date To:2019.06,Diameter:25mm	2021770L	Drive Shaft	31	28	56		538		
	2016.10-	8AT/6MT	F	R	Estate 4WD B46A20A/B48A20A	Date To:2019.06	2026330L	Drive Shaft	31	35	56		499		
	2016.10-	8AT/6MT	R	L/R	Estate 4WD B46A20A/B48A20A		2021760L	Drive Shaft	31	27	56		731		
	2016.10-	8AT	F	L	Estate 4WD B47C20A	Diameter:25mm	2021770L	Drive Shaft	31	28	56		538		
	2016.10-	8AT	F	R	Estate 4WD B47C20A		2026330L	Drive Shaft	31	35	56		499		
	2016.10-	8AT	R	L/R	Estate 4WD B47C20A		2021760L	Drive Shaft	31	27	56		731		
	2016.10-	8AT	F	L	Estate FWD B46A20A/B48A20A	Diameter:25mm	2021770L	Drive Shaft	31	28	56		538		
	2016.10-	8AT	F	L	Estate FWD B47C20A	Diameter:25mm	2021770L	Drive Shaft	31	28	56		538		
2.0 (131 kw)	2020.07-	8AT	R	L/R	Estate 4WD B46A20A/B48A20A		2021760L	Drive Shaft	31	27	56		731		
2.0 (140 kw)	2016.10-	8AT	F	L	Estate 4WD B47C20A/B47C20B	For Engine Code:B47C20A,Diameter:25mm	2021770L	Drive Shaft	31	28	56		538		
	2016.10-	8AT	F	R	Estate 4WD B47C20A/B47C20B	For Engine Code:B47C20A	2026330L	Drive Shaft	31	35	56		499		
	2016.10-	8AT	R	L/R	Estate 4WD B47C20A/B47C20B		2021760L	Drive Shaft	31	27	56		731		
	2016.10-	8AT	F	L	Estate FWD B47C20A/B47C20B	For Engine Code:B47C20A,Diameter:25mm	2021770L	Drive Shaft	31	28	56		538		
2.0 (141 kw)	2016.10-	8AT	F	L	Estate 4WD B46A20A/B48A20A	Date To:2019.06,Diameter:25mm	2021770L	Drive Shaft	31	28	56		538		
	2016.10-	8AT/6MT	F	R	Estate 4WD B46A20A/B48A20A	Date To:2019.06	2026330L	Drive Shaft	31	35	56		499		
	2016.10-	8AT/6MT	R	L/R	Estate 4WD B46A20A/B48A20A		2021760L	Drive Shaft	31	27	56		731		
	2016.10-	8AT	F	L	Estate FWD B46A20A/B48A20A		2021770L	Drive Shaft	31	28	56		538		
2.0 (170 kw)	2017.01-2019.06	8AT	F	L	Estate 4WD B48A20B	Diameter:25mm	2021770L	Drive Shaft	31	28	56		538		
	2017.01-2019.06	8AT/6MT	F	R	Estate 4WD B48A20B		2026330L	Drive Shaft	31	35	56		499		
	2017.01-2019.06	8AT/6MT	R	L/R	Estate 4WD B48A20B		2021760L	Drive Shaft	31	27	56		731		
Mini One															
1.2 (55 kw)	2014.07-2017.10	6MT	F	L	Hatchback FWD B38A12A		2023810L	Drive Shaft	31	34	56		527		
	2014.07-2017.10	6MT	F	R	Hatchback FWD B38A12A		2021740L	Drive Shaft	31	34	56		884		
1.2 (75 kw)	2014.03-2017.10	6AT	F	L	Hatchback FWD B38A12A		2023820L	Drive Shaft	31	26	56		500		
	2014.03-2017.10	6AT	F	R	Hatchback FWD B38A12A		2023800L	Drive Shaft	31	26	56		868		
	2014.03-2017.10	6MT	F	L	Hatchback FWD B38A12A		2023810L	Drive Shaft	31	34	56		527		
	2014.03-2017.10	6MT	F	R	Hatchback FWD B38A12A		2021740L	Drive Shaft	31	34	56		884		
	2016.03-2017.10	6MT	F	L	Cabriolet FWD B38A12A		2023810L	Drive Shaft	31	34	56		527		
	2016.03-2017.10	6MT	F	R	Cabriolet FWD B38A12A		2021740L	Drive Shaft	31	34	56		884		
	2016.03-2017.10	AT	F	L	Cabriolet FWD B38A12A	Date From:2016.01	2023820L	Drive Shaft	31	26	56		500		
1.5 (55 kw)	2017.11-	6MT	F	L	Hatchback FWD B38A15A		2023810L	Drive Shaft	31	34	56		527		
	2017.11-	6MT	F	R	Hatchback FWD B38A15A		2021740L	Drive Shaft	31	34	56		884		





	 YEAR	TRANSM.	F/R	L/R	BODY STYLE & DRIVE TYPE & ENGINE	REMARKS	GSP Ref.	 PRODUCT	 ABS	Technical Specifications				
										A	B	C	H	L
MINI														
Mini One														
1.5 (70 kw)	2014.03-	6AT/6MT	F	L	Hatchback FWD B37C15A		2023810L	Drive Shaft		31	34	56		527
	2014.03-	6AT/6MT	F	R	Hatchback FWD B37C15A		2021740L	Drive Shaft		31	34	56		884
1.5 (75 kw)	2017.11-	6MT	F	L	Cabriolet FWD B38A15A		2023810L	Drive Shaft		31	34	56		527
	2017.11-	6MT	F	R	Cabriolet FWD B38A15A		2021740L	Drive Shaft		31	34	56		884
	2017.11-	6MT	F	L	Hatchback FWD B38A15A		2023810L	Drive Shaft		31	34	56		527
	2017.11-	6MT	F	R	Hatchback FWD B38A15A		2021740L	Drive Shaft		31	34	56		884
MITSUBISHI														
L200														
2.2 (110 kw)	2019.07-	MT/6AT	F	L	Pick up 4WD 4N14		2391630L	Drive Shaft	47T	30	28	69	98	594
	2019.07-	MT/6AT	F	R	Pick up 4WD 4N14		2391640L	Drive Shaft	47T	30		69	98	489
2.4 (113 kw)	2015.09-	MT	F	L	Pick up 4WD 4N15		2391630L	Drive Shaft	47T	30	28	69	98	594
	2015.09-	MT	F	R	Pick up 4WD 4N15		2391640L	Drive Shaft	47T	30		69	98	489
2.4 (133 kw)	2015.09-	AT/MT	F	L	Pick up 4WD 4N15		2391630L	Drive Shaft	47T	30	28	69	98	594
	2015.09-	AT/MT	F	R	Pick up 4WD 4N15		2391640L	Drive Shaft	47T	30		69	98	489
2.5 (55 kw)	2011.08-2015.12	MT	F	L	Pick up 4WD 4D56		2391630L	Drive Shaft	47T	30	28	69	98	594
	2011.08-2015.12	MT	F	R	Pick up 4WD 4D56		2391640L	Drive Shaft	47T	30		69	98	489
2.5 (98 kw)	2005.11-2015.12	5MT	F	L	Pick up 4WD 4D56DOHC		2391630L	Drive Shaft	47T	30	28	69	98	594
	2005.11-2015.12	5MT	F	R	Pick up 4WD 4D56DOHC		2391640L	Drive Shaft	47T	30		69	98	489
2.5 (100 kw)	2005.11-2015.12	4AT/5MT	F	L	Pick up 4WD 4D56DOHC		2391630L	Drive Shaft	47T	30	28	69	98	594
	2005.11-2015.12	4AT/5MT	F	R	Pick up 4WD 4D56DOHC		2391640L	Drive Shaft	47T	30		69	98	489
2.5 (123 kw)	2007.10-2015.12	4AT/5MT	F	L	Pick up 4WD 4D56DOHC		2391630L	Drive Shaft	47T	30	28	69	98	594
	2007.10-2015.12	4AT/5MT	F	R	Pick up 4WD 4D56DOHC		2391640L	Drive Shaft	47T	30		69	98	489
2.5 (131 kw)	2009.06-2015.12	4AT/5AT/5MT	F	L	Pick up 4WD 4D56DOHC	8 balls	2391630L	Drive Shaft	47T	30	28	69	98	594
	2009.06-2015.12	4AT/5AT/5MT	F	R	Pick up 4WD 4D56DOHC	8 balls	2391640L	Drive Shaft	47T	30		69	98	489
	2009.09-2015.12	5MT	F	L	Platform/Chassis 4WD 4D56DOHC		2391630L	Drive Shaft	47T	30	28	69	98	594
	2009.09-2015.12	5MT	F	R	Platform/Chassis 4WD 4D56DOHC		2391640L	Drive Shaft	47T	30		69	98	489
Pajero Sport														
3.2 (121 kw)	2008.01-2015.12	4AT/5MT	F	L	Terrain cab wagon closed 4WD 4M41R	Date To:2008.12	2391630L	Drive Shaft	47T	30	28	69	98	594
	2008.01-2015.12	4AT/5MT	F	R	Terrain cab wagon closed 4WD 4M41R	Date To:2008.12	2391640L	Drive Shaft	47T	30		69	98	489
NISSAN														
Navara														
2.5 (106 kw)	2006.12-	MT	F	L/R	Pick up 4WD YD25DDTI		2412620L	Drive Shaft		29	27	67	115	637
	2008.08-	MT	F	L/R	Platform/Chassis 4WD YD25DDTI		2412620L	Drive Shaft		29	27	67	115	637
2.5 (126 kw)	2006.10-	AT/MT	F	L/R	Pick up 4WD YD25DDTI		2412620L	Drive Shaft		29	27	67	115	637
2.5 (128 kw)	2005.05-	AT/MT	F	L/R	Pick up 4WD YD25DDTI		2412620L	Drive Shaft		29	27	67	115	637
2.5 (140 kw)	2009.12-	AT/MT	F	L/R	Pick up 4WD YD25DDTI		2412620L	Drive Shaft		29	27	67	115	637
	2010.03-	5AT	F	L/R	Platform/Chassis 4WD YD25DDTI		2412620L	Drive Shaft		29	27	67	115	637
3.0 (170 kw)	2010.02-	AT/MT	F	L/R	Pick up 4WD V9X		2412620L	Drive Shaft		29	27	67	115	637
	2010.03-	AT/MT	F	L/R	Platform/Chassis 4WD V9X		2412620L	Drive Shaft		29	27	67	115	637
NV300														
1.6 (70 kw)	2016.09-	6MT	F	L	Bus FWD R9M413		2025480L	Drive Shaft		29	39	60	95.5	694
	2016.09-	6MT	F	R	Bus FWD R9M413		2184450L	Drive Shaft		29	39	60	95.5	1020
	2016.09-	6MT	F	L	Van FWD R9M413/R9M415		2025480L	Drive Shaft		29	39	60	95.5	694
	2016.09-	6MT	F	R	Van FWD R9M413/R9M415		2184450L	Drive Shaft		29	39	60	95.5	1020
1.6 (89 kw)	2016.09-	6MT	F	L	Van FWD R9M413		2025480L	Drive Shaft		29	39	60	95.5	694
	2016.09-	6MT	F	R	Van FWD R9M413		2184450L	Drive Shaft		29	39	60	95.5	1020
1.6 (92 kw)	2016.09-	6MT	F	L	Bus FWD R9M452		2025480L	Drive Shaft		29	39	60	95.5	694
	2016.09-	6MT	F	R	Bus FWD R9M452		2184450L	Drive Shaft		29	39	60	95.5	1020
	2016.09-	6MT	F	L	Platform/Chassis FWD R9M452		2025480L	Drive Shaft		29	39	60	95.5	694
	2016.09-	6MT	F	R	Platform/Chassis FWD R9M452		2184450L	Drive Shaft		29	39	60	95.5	1020
	2016.09-	6MT	F	L	Van FWD R9M452		2025480L	Drive Shaft		29	39	60	95.5	694
	2016.09-	6MT	F	R	Van FWD R9M452		2184450L	Drive Shaft		29	39	60	95.5	1020
	2016.09-	6MT	F	L	Van FWD R9M452		2025480L	Drive Shaft		29	39	60	95.5	694
1.6 (107 kw)	2016.09-	6MT	F	L	Bus FWD R9M452		2025480L	Drive Shaft		29	39	60	95.5	694
	2016.09-	6MT	F	R	Bus FWD R9M452		2184450L	Drive Shaft		29	39	60	95.5	1020
	2016.09-	6MT	F	L	Platform/Chassis FWD R9M452		2025480L	Drive Shaft		29	39	60	95.5	694
	2016.09-	6MT	F	R	Platform/Chassis FWD R9M452		2184450L	Drive Shaft		29	39	60	95.5	1020
	2016.09-	6MT	F	L	Van FWD R9M452		2025480L	Drive Shaft		29	39	60	95.5	694
	2016.09-	6MT	F	R	Van FWD R9M452		2184450L	Drive Shaft		29	39	60	95.5	1020
	2016.09-	6MT	F	L	Van FWD R9M452		2025480L	Drive Shaft		29	39	60	95.5	694
2.0 (88 kw)	2019.07-	6MT	F	L	Bus FWD M9R710		2025480L	Drive Shaft		29	39	60	95.5	694
	2019.07-	6MT	F	L	Van FWD M9R710		2025480L	Drive Shaft		29	39	60	95.5	694
2.0 (107 kw)	2019.07-	6MT	F	L	Bus FWD M9R710		2025480L	Drive Shaft		29	39	60	95.5	694
	2019.07-	6MT	F	L	Platform/Chassis FWD M9R710		2025480L	Drive Shaft		29	39	60	95.5	694
	2019.07-	6MT	F	L	Van FWD M9R710		2025480L	Drive Shaft		29	39	60	95.5	694
2.0 (125 kw)	2019.07-	6MT	F	L	Platform/Chassis FWD M9R710		2025480L	Drive Shaft		29	39	60	95.5	694
	2019.07-	6MT	F	L	Van FWD M9R710		2025480L	Drive Shaft		29	39	60	95.5	694

  YEAR	TRANSM.	F/R	L/R	BODY STYLE & DRIVE TYPE & ENGINE	REMARKS	GSP Ref.	 PRODUCT ABS	Technical Specifications						
								A	B	C	H	L		
NISSAN Pathfinder														
2.5 (120 kw)	2005.01-2010.06	AT/MT	F	L/R	SUV 4WD YD25DDTI		2412620L	Drive Shaft		29	27	67	115	637
2.5 (126 kw)	2006.09-2014.08	AT/MT	F	L/R	SUV 4WD YD25DDTI		2412620L	Drive Shaft		29	27	67	115	637
2.5 (128 kw)	2005.01-2010.06	AT/MT	F	L/R	SUV 4WD YD25DDTI		2412620L	Drive Shaft		29	27	67	115	637
2.5 (140 kw)	2010.07-2014.08	AT/MT	F	L/R	SUV 4WD YD25DDTI		2412620L	Drive Shaft		29	27	67	115	637
3.0 (170 kw)	2010.08-2014.08	AT/MT	F	L/R	SUV 4WD V9X		2412620L	Drive Shaft		29	27	67	115	637
4.0 (198 kw)	2005.01-2014.08	5AT	F	L/R	SUV 4WD VQ40DE		2412620L	Drive Shaft		29	27	67	115	637
OPEL Insignia														
1.6 (125 kw)	2013.06-2017.03	6AT	F	R	Hatchback FWD A16XHT/B16SHL		2210450L	Drive Shaft		30	27		94.5	615
	2013.06-2017.03	6AT	F	R	Saloon FWD A16XHT/B16SHL		2210450L	Drive Shaft		30	27		94.5	615
2.0 (96 kw)	2008.07-2017.03	6AT	F	L	Hatchback FWD A20DT/A20DTJ	Date To: 2011.12, Chassis no. to: B1999999	2210450L	Drive Shaft		30	27		94.5	615
	2008.07-2017.03	6AT	F	R	Hatchback FWD A20DT/A20DTJ	Date From: 2012.01, Chassis no. from: C1000000 Date To: 2011.12, Chassis no. to: B1999999	2210450L	Drive Shaft		30	27		94.5	615
	2008.07-2017.03	6AT	F	L	Saloon FWD A20DT/A20DTJ	Date To: 2011.12, Chassis no. to: B1999999	2210450L	Drive Shaft		30	27		94.5	615
	2008.07-2017.03	6AT	F	R	Saloon FWD A20DT/A20DTJ	Date From: 2012.01, Chassis no. from: C1000000 Date To: 2011.12, Chassis no. to: B1999999	2210450L	Drive Shaft		30	27		94.5	615
2.0 (118 kw)	2008.07-2017.03	6AT	F	L	Hatchback FWD A20DTH	Date To: 2011.12, Chassis no. to: B1999999	2210450L	Drive Shaft		30	27		94.5	615
	2008.07-2017.03	6AT	F	R	Hatchback FWD A20DTH	Date From: 2012.01, Chassis no. from: C1000000 Date To: 2011.12, Chassis no. to: B1999999	2210450L	Drive Shaft		30	27		94.5	615
	2008.07-2017.03	6AT	F	L	Saloon FWD A20DTH	Date To: 2011.12, Chassis no. to: B1999999	2210450L	Drive Shaft		30	27		94.5	615
	2008.07-2017.03	6AT	F	R	Saloon FWD A20DTH	Date From: 2012.01, Chassis no. from: C1000000 Date To: 2011.12, Chassis no. to: B1999999	2210450L	Drive Shaft		30	27		94.5	615
	2010.06-2017.03	6AT	F	L/R	Hatchback 4WD A20DTH	Date To: 2011.12, Chassis no. to: B1999999	2210450L	Drive Shaft		30	27		94.5	615
	2010.06-2017.03	6AT	F	L/R	Saloon 4WD A20DTH	Date To: 2011.12, Chassis no. to: B1999999	2210450L	Drive Shaft		30	27		94.5	615
2.0 (120 kw)	2013.07-2017.03	6AT	F	R	Hatchback FWD A20DTH		2210450L	Drive Shaft		30	27		94.5	615
	2013.07-2017.03	6AT	F	R	Saloon FWD A20DTH		2210450L	Drive Shaft		30	27		94.5	615
2.0 (125 kw)	2014.11-2017.03	6AT	F	R	Hatchback FWD B20DTH		2210450L	Drive Shaft		30	27		94.5	615
	2014.11-2017.03	6AT	F	R	Saloon FWD B20DTH		2210450L	Drive Shaft		30	27		94.5	615
2.0 (140 kw)	2008.07-2011.12	6AT	F	L/R	Hatchback FWD A20DTR		2210450L	Drive Shaft		30	27		94.5	615
	2008.07-2011.12	6AT	F	L/R	Saloon 4WD A20DTR		2210450L	Drive Shaft		30	27		94.5	615
	2008.07-2011.12	6AT	F	L/R	Saloon FWD A20DTR		2210450L	Drive Shaft		30	27		94.5	615
	2009.05-2011.12	6AT	F	L/R	Hatchback 4WD A20DTR		2210450L	Drive Shaft		30	27		94.5	615
2.0 (143 kw)	2012.01-2017.03	6AT	F	R	Hatchback 4WD A20DTR		2210450L	Drive Shaft		30	27		94.5	615
	2012.01-2017.03	6AT	F	R	Hatchback FWD A20DTR		2210450L	Drive Shaft		30	27		94.5	615
	2012.01-2017.03	6AT	F	R	Saloon 4WD A20DTR		2210450L	Drive Shaft		30	27		94.5	615
	2012.01-2017.03	6AT	F	R	Saloon FWD A20DTR		2210450L	Drive Shaft		30	27		94.5	615
2.0 (162 kw)	2008.07-2017.03	6AT	F	L/R	Hatchback 4WD A20NHT		2210450L	Drive Shaft		30	27		94.5	615
	2008.07-2017.03	6AT	F	L/R	Hatchback FWD A20NHT		2210450L	Drive Shaft		30	27		94.5	615
	2008.07-2017.03	6AT	F	L/R	Saloon 4WD A20NHT		2210450L	Drive Shaft		30	27		94.5	615
	2008.07-2017.03	6AT	F	L/R	Saloon FWD A20NHT		2210450L	Drive Shaft		30	27		94.5	615
	2008.08-2017.03	6AT	F	L/R	Saloon FWD A20NFT		2210450L	Drive Shaft		30	27		94.5	615
	2010.10-2017.03	6AT	F	L/R	Hatchback FWD A20NFT		2210450L	Drive Shaft		30	27		94.5	615
2.8 (191 kw)	2008.07-2017.03	6AT	F	L	Hatchback 4WD A28NET	Date To: 2010.12, Chassis no. to: A1999999	2210450L	Drive Shaft		30	27		94.5	615
	2008.07-2017.03	6AT	F	R	Hatchback 4WD A28NET		2210450L	Drive Shaft		30	27		94.5	615
	2008.07-2017.03	6AT	F	L	Saloon 4WD A28NET	Date To: 2010.12, Chassis no. to: A1999999	2210450L	Drive Shaft		30	27		94.5	615
	2008.07-2017.03	6AT	F	R	Saloon 4WD A28NET		2210450L	Drive Shaft		30	27		94.5	615
Insignia Country Tourer														
1.6 (125 kw)	2014.07-2017.03	6AT	F	R	Estate FWD A16XHT/B16SHL		2210450L	Drive Shaft		30	27		94.5	615
2.0 (120 kw)	2014.07-2017.03	6AT	F	R	Estate FWD A20DTH		2210450L	Drive Shaft		30	27		94.5	615
2.0 (125 kw)	2014.11-2017.03	6AT	F	R	Estate FWD B20DTH		2210450L	Drive Shaft		30	27		94.5	615
2.0 (143 kw)	2013.09-2017.03	6AT	F	R	Estate 4WD A20DTR		2210450L	Drive Shaft		30	27		94.5	615
Insignia Sports Tourer														
1.6 (125 kw)	2013.06-2017.03	6AT	F	R	Estate FWD A16XHT/B16SHL		2210450L	Drive Shaft		30	27		94.5	615
2.0 (96 kw)	2008.07-2017.03	6AT	F	L	Estate FWD A20DT/A20DTJ	Date To: 2011.12, Chassis no. to: B1999999	2210450L	Drive Shaft		30	27		94.5	615
	2008.07-2017.03	6AT	F	R	Estate FWD A20DT/A20DTJ	Date From: 2012.01, Chassis no. from: C1000000 Date To: 2011.12, Chassis no. to: B1999999	2210450L	Drive Shaft		30	27		94.5	615
2.0 (118 kw)	2008.07-2017.03	6AT	F	L	Estate FWD A20DTH	Date To: 2011.12, Chassis no. to: B1999999	2210450L	Drive Shaft		30	27		94.5	615
	2008.07-2017.03	6AT	F	R	Estate FWD A20DTH	Date From: 2012.01, Chassis no. from: C1000000 Date To: 2011.12, Chassis no. to: B1999999	2210450L	Drive Shaft		30	27		94.5	615
	2010.06-2017.03	6AT	F	L/R	Estate 4WD A20DTH	Date To: 2011.12, Chassis no. to: B1999999	2210450L	Drive Shaft		30	27		94.5	615
2.0 (120 kw)	2013.07-2017.03	6AT	F	R	Estate FWD A20DTH		2210450L	Drive Shaft		30	27		94.5	615
2.0 (125 kw)	2014.11-2017.03	6AT	F	R	Estate FWD B20DTH		2210450L	Drive Shaft		30	27		94.5	615
2.0 (140 kw)	2008.07-2011.12	6AT	F	L/R	Estate 4WD A20DTR		2210450L	Drive Shaft		30	27		94.5	615
	2008.07-2011.12	6AT	F	L/R	Estate FWD A20DTR		2210450L	Drive Shaft		30	27		94.5	615
2.0 (143 kw)	2012.01-2015.06	6AT	F	R	Estate 4WD A20DTR		2210450L	Drive Shaft		30	27		94.5	615
	2012.01-2017.03	6AT	F	R	Estate FWD A20DTR		2210450L	Drive Shaft		30	27		94.5	615
2.0 (162 kw)	2008.07-2017.03	6AT	F	L/R	Estate 4WD A20NHT		2210450L	Drive Shaft		30	27		94.5	615
	2008.07-2017.03	6AT	F	L/R	Estate FWD A20NHT		2210450L	Drive Shaft		30	27		94.5	615
	2010.10-2017.03	6AT	F	L/R	Estate FWD A20NFT		2210450L	Drive Shaft		30	27		94.5	615
2.8 (191 kw)	2008.07-2017.03	6AT	F	L	Estate 4WD A28NET	Date To: 2010.12, Chassis no. to: A1999999	2210450L	Drive Shaft		30	27		94.5	615
	2008.07-2017.03	6AT	F	R	Estate 4WD A28NET		2210450L	Drive Shaft		30	27		94.5	615





 YEAR	TRANSM.	F/R	L/R	BODY STYLE & DRIVE TYPE & ENGINE	REMARKS	GSP Ref.	 PRODUCT	 ABS	Technical Specifications										
									A	B	C	H	L						
OPEL Vivaro																			
1.6 (66 kw)	2014.06-2016.12	6MT	F	L	Bus FWD R9M408		2025480L	Drive Shaft		29	39	60	95.5	694					
	2014.06-2016.12	6MT	F	R	Bus FWD R9M408		2184450L	Drive Shaft		29	39	60	95.5	1020					
	2014.06-2016.12	6MT	F	L	Van FWD R9M408		2025480L	Drive Shaft		29	39	60	95.5	694					
	2014.06-2016.12	6MT	F	R	Van FWD R9M408		2184450L	Drive Shaft		29	39	60	95.5	1020					
1.6 (70 kw)	2015.04-2019.12	6MT	F	L	Bus FWD R9M413/R9M415		2025480L	Drive Shaft		29	39	60	95.5	694					
	2015.04-2019.12	6MT	F	R	Bus FWD R9M413/R9M415		2184450L	Drive Shaft		29	39	60	95.5	1020					
	2016.03-2019.12	6MT	F	L	Van FWD R9M413/R9M415		2025480L	Drive Shaft		29	39	60	95.5	694					
	2016.03-2019.12	6MT	F	R	Van FWD R9M413/R9M415		2184450L	Drive Shaft		29	39	60	95.5	1020					
1.6 (85 kw)	2014.06-2016.12	6MT	F	L	Bus FWD R9M408		2025480L	Drive Shaft		29	39	60	95.5	694					
	2014.06-2016.12	6MT	F	R	Bus FWD R9M408		2184450L	Drive Shaft		29	39	60	95.5	1020					
	2014.06-2016.12	6MT	F	L	Platform/Chassis FWD R9M408		2025480L	Drive Shaft		29	39	60	95.5	694					
	2014.06-2016.12	6MT	F	R	Platform/Chassis FWD R9M408		2184450L	Drive Shaft		29	39	60	95.5	1020					
	2014.06-2016.12	6MT	F	L	Van FWD R9M408		2025480L	Drive Shaft		29	39	60	95.5	694					
	2014.06-2016.12	6MT	F	R	Van FWD R9M408		2184450L	Drive Shaft		29	39	60	95.5	1020					
1.6 (88 kw)	2014.06-2019.12	6MT	F	L	Bus FWD R9M450		2025480L	Drive Shaft		29	39	60	95.5	694					
	2014.06-2019.12	6MT	F	R	Bus FWD R9M450		2184450L	Drive Shaft		29	39	60	95.5	1020					
	2014.06-2019.12	6MT	F	L	Van FWD R9M450		2025480L	Drive Shaft		29	39	60	95.5	694					
	2014.06-2019.12	6MT	F	R	Van FWD R9M450		2184450L	Drive Shaft		29	39	60	95.5	1020					
	2015.08-2019.12	6MT	F	L	Platform/Chassis FWD R9M450		2025480L	Drive Shaft		29	39	60	95.5	694					
	2015.08-2019.12	6MT	F	R	Platform/Chassis FWD R9M450		2184450L	Drive Shaft		29	39	60	95.5	1020					
1.6 (89 kw)	2016.03-2019.12	6MT	F	L	Van FWD R9M413/R9M415		2025480L	Drive Shaft		29	39	60	95.5	694					
	2016.03-2019.12	6MT	F	R	Van FWD R9M413/R9M415		2184450L	Drive Shaft		29	39	60	95.5	1020					
	2019.01-2019.12	6MT	F	L	Bus FWD R9M415		2025480L	Drive Shaft		29	39	60	95.5	694					
	2019.01-2019.12	6MT	F	R	Bus FWD R9M415		2184450L	Drive Shaft		29	39	60	95.5	1020					
1.6 (92 kw)	2015.04-2019.12	6MT	F	L	Bus FWD R9M452		2025480L	Drive Shaft		29	39	60	95.5	694					
	2015.04-2019.12	6MT	F	R	Bus FWD R9M452		2184450L	Drive Shaft		29	39	60	95.5	1020					
	2016.03-2019.12	6MT	F	L	Van FWD R9M452		2025480L	Drive Shaft		29	39	60	95.5	694					
	2016.03-2019.12	6MT	F	R	Van FWD R9M452		2184450L	Drive Shaft		29	39	60	95.5	1020					
	2016.11-2019.12	6MT	F	L	Platform/Chassis FWD R9M452		2025480L	Drive Shaft		29	39	60	95.5	694					
	2016.11-2019.12	6MT	F	R	Platform/Chassis FWD R9M452		2184450L	Drive Shaft		29	39	60	95.5	1020					
1.6 (103 kw)	2014.06-2016.12	6MT	F	L	Bus FWD R9M450		2025480L	Drive Shaft		29	39	60	95.5	694					
	2014.06-2016.12	6MT	F	R	Bus FWD R9M450		2184450L	Drive Shaft		29	39	60	95.5	1020					
	2014.06-2016.12	6MT	F	L	Van FWD R9M450		2025480L	Drive Shaft		29	39	60	95.5	694					
	2014.06-2016.12	6MT	F	R	Van FWD R9M450		2184450L	Drive Shaft		29	39	60	95.5	1020					
	2015.08-2016.12	6MT	F	L	Platform/Chassis FWD R9M450		2025480L	Drive Shaft		29	39	60	95.5	694					
	2015.08-2016.12	6MT	F	R	Platform/Chassis FWD R9M450		2184450L	Drive Shaft		29	39	60	95.5	1020					
1.6 (107 kw)	2015.04-2019.12	6MT	F	L	Bus FWD R9M452		2025480L	Drive Shaft		29	39	60	95.5	694					
	2015.04-2019.12	6MT	F	R	Bus FWD R9M452		2184450L	Drive Shaft		29	39	60	95.5	1020					
	2016.03-2019.12	6MT	F	L	Van FWD R9M452		2025480L	Drive Shaft		29	39	60	95.5	694					
	2016.03-2019.12	6MT	F	R	Van FWD R9M452		2184450L	Drive Shaft		29	39	60	95.5	1020					
	2016.11-2019.12	6MT	F	L	Platform/Chassis FWD R9M452		2025480L	Drive Shaft		29	39	60	95.5	694					
	2016.11-2019.12	6MT	F	R	Platform/Chassis FWD R9M452		2184450L	Drive Shaft		29	39	60	95.5	1020					
PORSCHE Cayenne																			
3.0 (155 kw)	2010.10-	AT	F	L/R	SUV 4WD MCRCB/MCVVC	Date From:2011.01	2350850L	Drive Shaft		30		64.4	103.5	526					
3.0 (176 kw)	2009.02-2010.05	AT	F	L/R	SUV 4WD M059D		2350850L	Drive Shaft		30		64.4	103.5	526					
	2009.02-2010.05	AT/MT	R	L/R	SUV 4WD M059D	With differential lock.For MI code:ID50/I1Y1	2350860L	Drive Shaft		30			103.5	724					
	2009.02-2010.05	AT/MT	R	L/R	SUV 4WD M059D	Without differential lock,MI code:ID50	2612360L	Drive Shaft		30		64	103.5	737					
	2010.06-2011.09	8AT	F	R	SUV 4WD M059E		2350850L	Drive Shaft		30		64.4	103.5	526					
	2010.06-2011.09	8AT	R	R	SUV 4WD M059E	Without differential lock	2011060L	Drive Shaft		30	32		103.5	865					
3.0 (180 kw)	2010.06-	8AT	R	L/R	SUV 4WD MCRCA		2011060L	Drive Shaft		30	32		103.5	865					
3.0 (184 kw)	2014.08-	AT	F	L/R	SUV 4WD MCVVB	Date From:2015.01	2350850L	Drive Shaft		30		64.4	103.5	526					
3.0 (193 kw)	2014.10-	AT	F	L/R	SUV 4WD MCVVA	Date From:2015.01	2350850L	Drive Shaft		30		64.4	103.5	526					
3.0 (245 kw)	2010.06-	8AT	F	R	SUV 4WD M 06.EC/MCG.E/MCG.EA/MCG.FA		2350850L	Drive Shaft		30		64.4	103.5	526					
	2010.06-	8AT	R	R	SUV 4WD M 06.EC/MCG.E/MCG.EA/MCG.FA	Without differential lock	2011060L	Drive Shaft		30	32		103.5	865					
3.0 (306 kw)	2014.10-	8AT	F	L/R	SUV 4WD MCGEA/MCGFA		2350850L	Drive Shaft		30		64.4	103.5	526					
3.2 (177 kw)	2003.08-2006.12	AT/MT	F	L/R	SUV 4WD M022Y		2350850L	Drive Shaft		30		64.4	103.5	526					
	2003.08-2006.12	AT/MT	R	L/R	SUV 4WD M022Y	With differential lock.For MI code:IT31/I1Y1	2350860L	Drive Shaft		30			103.5	724					
	2003.08-2006.12	AT/MT	R	L/R	SUV 4WD M022Y	Differential/Without differential lock.For MI code:IT31	2612360L	Drive Shaft		30		64	103.5	737					
3.2 (184 kw)	2003.10-2006.12	AT	F	L/R	SUV 4WD M022Y		2350850L	Drive Shaft		30		64.4	103.5	526					
	2003.10-2006.12	AT	R	L/R	SUV 4WD M022Y	With differential lock	2350860L	Drive Shaft		30			103.5	724					
	2003.10-2006.12	AT	R	L/R	SUV 4WD M022Y	Differential/Without differential lock.For MI code:IT31	2612360L	Drive Shaft		30		64	103.5	737					
3.6 (213 kw)	2007.02-2010.05	6AT/6MT	F	L/R	SUV 4WD M5501		2350850L	Drive Shaft		30		64.4	103.5	526					
	2007.02-2010.05	6AT/6MT	R	L/R	SUV 4WD M5501	With differential lock	2350860L	Drive Shaft		30			103.5	724					
	2007.02-2010.05	6AT/6MT	R	L/R	SUV 4WD M5501	Differential/Without differential lock	2612360L	Drive Shaft		30		64	103.5	737					



	 YEAR	TRANSM.	F/R	L/R	BODY STYLE & DRIVE TYPE & ENGINE	REMARKS	GSP Ref.	 PRODUCT ABS	Technical Specifications				
									A	B	C	H	L
PORSCHE Cayenne													
3.6 (309 kw)	2014.10-	AT	R	L/R	SUV 4WD MCURA		2011060L	Drive Shaft	30	32		103.5	865
3.6 (324 kw)	2015.02-	AT	R	L/R	SUV 4WD MCXZA		2011060L	Drive Shaft	30	32		103.5	865
4.2 (281 kw)	2012.10-2014.09	AT	R	R	SUV 4WD MCUDB	Without differential lock,MI code:11Y0	2011060L	Drive Shaft	30	32		103.5	865
4.2 (283 kw)	2014.10-	AT	R	R	SUV 4WD MCUDC	Without differential lock,MI code:11Y0	2011060L	Drive Shaft	30	32		103.5	865
4.5 (250 kw)	2002.08-2006.12	AT/MT	F	L/R	SUV 4WD M4800		2350850L	Drive Shaft	30		64.4	103.5	526
	2002.08-2006.12	AT	R	L/R	SUV 4WD M4800		2612360L	Drive Shaft	30		64	103.5	737
	2002.08-2006.12	MT	R	L/R	SUV 4WD M4800		2350860L	Drive Shaft	30			103.5	724
4.5 (331 kw)	2002.08-2006.12	6AT	F	L/R	SUV 4WD M4850		2350850L	Drive Shaft	30		64.4	103.5	526
	2002.08-2006.12	6AT	R	L/R	SUV 4WD M4850		2612360L	Drive Shaft	30		64	103.5	737
4.5 (368 kw)	2004.01-2005.10	AT	F	L/R	SUV 4WD M4850S		2350850L	Drive Shaft	30		64.4	103.5	526
	2004.01-2005.10	AT	R	L/R	SUV 4WD M4850S		2350860L	Drive Shaft	30			103.5	724
	2004.01-2005.10		R	L/R	SUV 4WD M4850S	Date To:2005.10,Differential/without differential lock	2612360L	Drive Shaft	30		64	103.5	737
4.5 (383 kw)	2006.03-2010.05	AT	F	L/R	SUV 4WD M4850T		2350850L	Drive Shaft	30		64.4	103.5	526
	2006.03-2010.05	AT	R	L/R	SUV 4WD M4850T		2350860L	Drive Shaft	30			103.5	724
	2006.03-2010.05		R	L/R	SUV 4WD M4850T	Differential:without differential lock	2612360L	Drive Shaft	30		64	103.5	737
4.8 (283 kw)	2007.02-2010.12	6AT/6MT	F	L/R	SUV 4WD M4801		2350850L	Drive Shaft	30		64.4	103.5	526
	2007.02-2010.12	AT	R	L/R	SUV 4WD M4801		2612360L	Drive Shaft	30		64	103.5	737
	2007.02-2010.12	MT	R	L/R	SUV 4WD M4801		2350860L	Drive Shaft	30			103.5	724
4.8 (294 kw)	2010.06-2014.09	8AT	F	R	SUV 4WD M4802		2350850L	Drive Shaft	30		64.4	103.5	526
	2010.06-2014.09	8AT	R	R	SUV 4WD M4802	Without differential lock	2011060L	Drive Shaft	30	32		103.5	865
4.8 (298 kw)	2007.10-2010.12	6AT/6MT	F	L/R	SUV 4WD M4801		2350850L	Drive Shaft	30		64.4	103.5	526
	2007.10-2010.12	AT	R	L/R	SUV 4WD M4801		2612360L	Drive Shaft	30		64	103.5	737
	2007.10-2010.12	MT	R	L/R	SUV 4WD M4801		2350860L	Drive Shaft	30			103.5	724
4.8 (309 kw)	2012.06-2014.09	AT	F	L/R	SUV 4WD M4802	Date To:2014.09	2350850L	Drive Shaft	30		64.4	103.5	526
	2012.06-2014.09	AT	R	R	SUV 4WD M4802	Without differential lock,MI code:11Y0	2011060L	Drive Shaft	30	32		103.5	865
4.8 (368 kw)	2006.12-2010.05	6AT	F	L/R	SUV 4WD M4851		2350850L	Drive Shaft	30		64.4	103.5	526
	2006.12-2010.05	6AT	R	L/R	SUV 4WD M4851		2350860L	Drive Shaft	30			103.5	724
	2010.06-2014.09	8AT	F	R	SUV 4WD M4852		2350850L	Drive Shaft	30		64.4	103.5	526
	2010.06-2014.09	8AT	R	R	SUV 4WD M4852	Without differential lock	2011060L	Drive Shaft	30	32		103.5	865
4.8 (382 kw)	2014.10-	AT	R	L/R	SUV 4WD MCFTB		2011060L	Drive Shaft	30	32		103.5	865
4.8 (397 kw)	2008.08-2010.05	6AT	F	L/R	SUV 4WD M4851		2350850L	Drive Shaft	30		64.4	103.5	526
	2008.08-2010.05	6AT	R	L/R	SUV 4WD M4851		2350860L	Drive Shaft	30			103.5	724
	2010.06-2014.09	8AT	R	L/R	SUV 4WD M4852		2011060L	Drive Shaft	30	32		103.5	865
4.8 (404 kw)	2008.08-2010.05	AT	F	L/R	SUV 4WD M4851		2350850L	Drive Shaft	30		64.4	103.5	526
	2008.08-2010.05	AT	R	L/R	SUV 4WD M4851	Differential/Without differential lock,For MI code:05V/GDR	2612360L	Drive Shaft	30		64	103.5	737
	2008.08-2010.05	MT	R	L/R	SUV 4WD M4851	With differential lock,For MI code:ID5V/11Y1	2350860L	Drive Shaft	30			103.5	724
4.8 (405 kw)	2012.10-2014.09	AT	R	L/R	SUV 4WD M4852		2011060L	Drive Shaft	30	32		103.5	865
4.8 (419 kw)	2015.01-	8AT	F	R	SUV 4WD MCYXA		2350850L	Drive Shaft	30		64.4	103.5	526
Macan													
2.0 (174 kw)	2014.07-2018.09		F	L/R	SUV 4WD MCNCC		2020770L	Drive Shaft	42		76.5	34	495
	2014.07-2018.09	AT	R	L/R	SUV 4WD MCNCC		2613380L	Drive Shaft	42	32		34	778
2.0 (180 kw)	2018.05-	7AT	F	L/R	SUV 4WD DKNA		2020770L	Drive Shaft	42		76.5	34	495
2.0 (185 kw)	2015.01-	7AT	F	L/R	SUV 4WD DLHB/MCYPA		2020770L	Drive Shaft	42		76.5	34	495
	2015.01-	7AT	R	L	SUV 4WD DLHB/MCYPA	With differential lock,MI code:1Y1	2613380L	Drive Shaft	42	32		34	778
3.0 (155 kw)	2014.02-2018.09		F	L/R	SUV 4WD MCTBB		2020770L	Drive Shaft	42		76.5	34	495
	2014.02-2018.09	AT	R	L/R	SUV 4WD MCTBB		2613380L	Drive Shaft	42	32		34	778
3.0 (180 kw)	2014.02-2018.09		F	L/R	SUV 4WD MCDUD		2020770L	Drive Shaft	42		76.5	34	495
	2014.02-2018.09	DCT	R	L/R	SUV 4WD MCDUD		2613380L	Drive Shaft	42	32		34	778
3.0 (184 kw)	2014.02-2018.09	7AT	F	L/R	SUV 4WD MCTBC		2020770L	Drive Shaft	42		76.5	34	495
	2014.02-2018.09	AT	R	L/R	SUV 4WD MCTBC		2613380L	Drive Shaft	42	32		34	778
3.0 (190 kw)	2014.02-2018.09	7AT	F	L/R	SUV 4WD MCTBA		2020770L	Drive Shaft	42		76.5	34	495
	2014.02-2018.09	7AT	R	L/R	SUV 4WD MCTBA		2613380L	Drive Shaft	42	32		34	778
3.0 (250 kw)	2014.02-2018.09	7AT	F	L/R	SUV 4WD MCTMA		2020770L	Drive Shaft	42		76.5	34	495
	2014.02-2018.09	7AT	R	L	SUV 4WD MCTMA	With differential lock,MI code:1Y1	2613380L	Drive Shaft	42	32		34	778
3.0 (260 kw)	2018.05-	7AT	F	L/R	SUV 4WD DLZB		2020770L	Drive Shaft	42		76.5	34	495
3.0 (265 kw)	2015.11-2018.09	7AT	F	L/R	SUV 4WD MDCNA		2020770L	Drive Shaft	42		76.5	34	495
	2015.11-2018.09	DCT	R	L/R	SUV 4WD MDCNA		2613380L	Drive Shaft	42	32		34	778
3.6 (294 kw)	2014.02-2018.09	7AT	F	L/R	SUV 4WD MCTLA		2015300L	Drive Shaft	42		76.5	34	496
	2014.02-2018.09	7AT	F	L/R	SUV 4WD MCTLA	Date to:2016.03	2020770L	Drive Shaft	42		76.5	34	495
	2014.02-2018.09	AT	R	L/R	SUV 4WD MCTLA		2613380L	Drive Shaft	42	32		34	778
3.6 (324 kw)	2016.09-2018.09	7AT	F	L/R	SUV 4WD MDHKA		2015300L	Drive Shaft	42		76.5	34	496
	2016.09-2018.09	7AT	R	L	SUV 4WD MDHKA	With differential lock,MI code:1Y1	2613380L	Drive Shaft	42	32		34	778



  YEAR	TRANSM.	F/R	L/R	BODY STYLE & DRIVE TYPE & ENGINE	REMARKS	GSP Ref.	 PRODUCT	 ABS	Technical Specifications				
									A	B	C	H	L
RENAULT													
Trafic III													
1.6 (66 kw)	2014.06-	6MT	F	L	Bus FWD R9M408	2025480L	Drive Shaft		29	39	60	95.5	694
	2014.06-	6MT	F	R	Bus FWD R9M408	2184450L	Drive Shaft		29	39	60	95.5	1020
	2014.06-	6MT	F	L	Van FWD R9M408	2025480L	Drive Shaft		29	39	60	95.5	694
	2014.06-	6MT	F	R	Van FWD R9M408	2184450L	Drive Shaft		29	39	60	95.5	1020
1.6 (70 kw)	2015.07-	6MT	F	L	Bus FWD R9M413/R9M415	2025480L	Drive Shaft		29	39	60	95.5	694
	2015.07-	6MT	F	R	Bus FWD R9M413/R9M415	2184450L	Drive Shaft		29	39	60	95.5	1020
	2015.07-	6MT	F	L	Van FWD R9M413/R9M415	2025480L	Drive Shaft		29	39	60	95.5	694
	2015.07-	6MT	F	R	Van FWD R9M413/R9M415	2184450L	Drive Shaft		29	39	60	95.5	1020
1.6 (85 kw)	2014.06-	6MT	F	L	Bus FWD R9M408	2025480L	Drive Shaft		29	39	60	95.5	694
	2014.06-	6MT	F	R	Bus FWD R9M408	2184450L	Drive Shaft		29	39	60	95.5	1020
	2014.06-	6MT	F	L	Van FWD R9M408	2025480L	Drive Shaft		29	39	60	95.5	694
	2014.06-	6MT	F	R	Van FWD R9M408	2184450L	Drive Shaft		29	39	60	95.5	1020
1.6 (88 kw)	2014.06-	6MT	F	L	Bus FWD R9M450	2025480L	Drive Shaft		29	39	60	95.5	694
	2014.06-	6MT	F	R	Bus FWD R9M450	2184450L	Drive Shaft		29	39	60	95.5	1020
	2014.06-	6MT	F	L	Platform/Chassis FWD R9M450	2025480L	Drive Shaft		29	39	60	95.5	694
	2014.06-	6MT	F	R	Platform/Chassis FWD R9M450	2184450L	Drive Shaft		29	39	60	95.5	1020
	2014.06-	6MT	F	L	Van FWD R9M450	2025480L	Drive Shaft		29	39	60	95.5	694
	2014.06-	6MT	F	R	Van FWD R9M450	2184450L	Drive Shaft		29	39	60	95.5	1020
1.6 (89 kw)	2015.07-	6MT	F	L	Van FWD R9M413	2025480L	Drive Shaft		29	39	60	95.5	694
	2015.07-	6MT	F	R	Van FWD R9M413	2184450L	Drive Shaft		29	39	60	95.5	1020
	2019.01-	6MT	F	L	Bus FWD R9M415	2025480L	Drive Shaft		29	39	60	95.5	694
	2019.01-	6MT	F	R	Bus FWD R9M415	2184450L	Drive Shaft		29	39	60	95.5	1020
1.6 (92 kw)	2015.07-	6MT	F	L	Bus FWD R9M452	2025480L	Drive Shaft		29	39	60	95.5	694
	2015.07-	6MT	F	R	Bus FWD R9M452	2184450L	Drive Shaft		29	39	60	95.5	1020
	2015.07-	6MT	F	L	Platform/Chassis FWD R9M452	2025480L	Drive Shaft		29	39	60	95.5	694
	2015.07-	6MT	F	R	Platform/Chassis FWD R9M452	2184450L	Drive Shaft		29	39	60	95.5	1020
	2015.07-	6MT	F	L	Van FWD R9M452	2025480L	Drive Shaft		29	39	60	95.5	694
	2015.07-	6MT	F	R	Van FWD R9M452	2184450L	Drive Shaft		29	39	60	95.5	1020
1.6 (103 kw)	2014.06-	6MT	F	L	Bus FWD R9M450	2025480L	Drive Shaft		29	39	60	95.5	694
	2014.06-	6MT	F	R	Bus FWD R9M450	2184450L	Drive Shaft		29	39	60	95.5	1020
	2014.06-	6MT	F	L	Platform/Chassis FWD R9M450	2025480L	Drive Shaft		29	39	60	95.5	694
	2014.06-	6MT	F	R	Platform/Chassis FWD R9M450	2184450L	Drive Shaft		29	39	60	95.5	1020
	2014.06-	6MT	F	L	Van FWD R9M450	2025480L	Drive Shaft		29	39	60	95.5	694
	2014.06-	6MT	F	R	Van FWD R9M450	2184450L	Drive Shaft		29	39	60	95.5	1020
1.6 (107 kw)	2015.07-	6MT	F	L	Bus FWD R9M452	2025480L	Drive Shaft		29	39	60	95.5	694
	2015.07-	6MT	F	R	Bus FWD R9M452	2184450L	Drive Shaft		29	39	60	95.5	1020
	2015.07-	6MT	F	L	Platform/Chassis FWD R9M452	2025480L	Drive Shaft		29	39	60	95.5	694
	2015.07-	6MT	F	R	Platform/Chassis FWD R9M452	2184450L	Drive Shaft		29	39	60	95.5	1020
	2015.07-	6MT	F	L	Van FWD R9M452	2025480L	Drive Shaft		29	39	60	95.5	694
	2015.07-	6MT	F	R	Van FWD R9M452	2184450L	Drive Shaft		29	39	60	95.5	1020
2.0 (81 kw)	2021.05-	6MT	F	L	Bus FWD M9R714	2025480L	Drive Shaft		29	39	60	95.5	694
2.0 (88 kw)	2019.06-	6MT	F	L	Bus FWD M9R710	2025480L	Drive Shaft		29	39	60	95.5	694
	2019.06-	6MT	F	L	Van FWD M9R710	2025480L	Drive Shaft		29	39	60	95.5	694
2.0 (107 kw)	2019.06-	6MT	F	L	Bus FWD M9R710	2025480L	Drive Shaft		29	39	60	95.5	694
	2019.06-	6MT	F	L	Platform/Chassis FWD M9R710	2025480L	Drive Shaft		29	39	60	95.5	694
	2019.06-	6MT	F	L	Van FWD M9R710	2025480L	Drive Shaft		29	39	60	95.5	694
2.0 (110 kw)	2021.05-	6MT	F	L	Bus FWD M9R714	2025480L	Drive Shaft		29	39	60	95.5	694
2.0 (125 kw)	2019.06-	6MT	F	L	Bus FWD M9R710/M9R714	2025480L	Drive Shaft		29	39	60	95.5	694
	2019.06-	6MT	F	L	Platform/Chassis FWD M9R710	2025480L	Drive Shaft		29	39	60	95.5	694
	2019.06-	6MT	F	L	Van FWD M9R710	2025480L	Drive Shaft		29	39	60	95.5	694
SAAB													
9-5													
2.0 (118 kw)	2010.05-2012.07	6AT	F	L/R	Saloon FWD A20DTH	2210450L	Drive Shaft		30	27		94.5	615
2.0 (140 kw)	2010.05-2012.07	6AT	F	L/R	Saloon 4WD A20DTR	2210450L	Drive Shaft		30	27		94.5	615
2.0 (162 kw)	2010.05-2012.07	6AT	F	L/R	Saloon 4WD A20NFT	2210450L	Drive Shaft		30	27		94.5	615
	2010.05-2012.07	6AT	F	L/R	Saloon 4WD A20NHT	2210450L	Drive Shaft		30	27		94.5	615
	2010.05-2012.07	6AT	F	L/R	Saloon FWD A20NFT	2210450L	Drive Shaft		30	27		94.5	615
	2010.05-2012.07	6AT	F	L/R	Saloon FWD A20NHT	2210450L	Drive Shaft		30	27		94.5	615
SEAT													
Alhambra													
1.4 (110 kw)	2010.06-	6MT	F	R	MPV FWD CAVA/CNWB/CTHA	2033130L	Drive Shaft		36		59.5	40.5	794
	2010.06-	6MT/6DCT	F	L	MPV FWD CAVA/CNWB/CTHA	2032950L	Drive Shaft		36		59.5	40.5	486
	2015.05-	6DCT	F	R	MPV FWD CZDA/DJKA	Date To:2016.04 2033130L	Drive Shaft		36		59.5	40.5	794
	2015.05-	6MT	F	R	MPV FWD CZDA/DJKA	2033130L	Drive Shaft		36		59.5	40.5	794
	2015.05-	6MT/6DCT	F	L	MPV FWD CZDA/DJKA	2032950L	Drive Shaft		36		59.5	40.5	486



	 YEAR	TRANSM.	F/R	L/R	BODY STYLE & DRIVE TYPE & ENGINE	REMARKS	GSP Ref.	 PRODUCT	 ABS	Technical Specifications				
										A	B	C	H	L
SEAT														
Alhambra														
1.8 (118 kw)	2012.11-	AT	F	L	MPV FWD CDAA		2032950L	Drive Shaft		36	59.5	40.5	486	
2.0 (85 kw)	2011.05-	6MT	F	L	MPV FWD CFFE/CUVA/DFLD/DLTC		2032950L	Drive Shaft		36	59.5	40.5	486	
	2011.05-	6MT	F	R	MPV FWD CFFE/CUVA/DFLD/DLTC		2033130L	Drive Shaft		36	59.5	40.5	794	
2.0 (100 kw)	2010.06-2011.05	6DCT	F	R	MPV FWD CFFA		2033540L	Drive Shaft		36	59.5	40	760	
	2010.06-2011.05	6MT	F	L	MPV FWD CFFA		2032950L	Drive Shaft		36	59.5	40.5	486	
	2010.06-2011.05	6MT	F	R	MPV FWD CFFA		2033130L	Drive Shaft		36	59.5	40.5	794	
2.0 (103 kw)	2010.06-	6DCT	F	R	MPV FWD CFFB		2033540L	Drive Shaft		36	59.5	40	760	
	2010.06-	6MT	F	L	MPV FWD CFFB		2032950L	Drive Shaft		36	59.5	40.5	486	
	2010.06-	6MT	F	R	MPV FWD CFFB		2033130L	Drive Shaft		36	59.5	40.5	794	
	2011.05-	AT	F	R	MPV 4WD CFFB		2033540L	Drive Shaft		36	59.5	40	760	
2.0 (110 kw)	2015.05-	6DCT	F	R	MPV FWD CUVC/DFLA/DLTA		2033540L	Drive Shaft		36	59.5	40	760	
	2015.05-	6MT	F	L	MPV FWD CUVC/DFLA/DLTA		2032950L	Drive Shaft		36	59.5	40.5	486	
	2015.05-	6MT	F	R	MPV FWD CUVC/DFLA/DLTA		2033130L	Drive Shaft		36	59.5	40.5	794	
2.0 (125 kw)	2010.06-2013.02	6DCT	F	R	MPV FWD CFGB		2033540L	Drive Shaft		36	59.5	40	760	
2.0 (130 kw)	2012.11-	6DCT	F	R	MPV FWD CFGC/DLUB		2033540L	Drive Shaft		36	59.5	40	760	
	2012.11-		F	L	MPV FWD CFGC/DLUB		2032950L	Drive Shaft		36	59.5	40.5	486	
2.0 (135 kw)	2015.05-	6DCT	F	R	MPV FWD CUWA		2033540L	Drive Shaft		36	59.5	40	760	
2.0 (147 kw)	2015.05-	MT	F	L	MPV FWD CUWA		2032950L	Drive Shaft		36	59.5	40.5	486	
	2010.11-2012.05	6AT	F	L	MPV FWD CCZA	Date To:2014.07	2032950L	Drive Shaft		36	59.5	40.5	486	
2.0 (162 kw)	2010.11-2012.05		F	R	MPV FWD CCZA	Date To:2011.11;Type:1	2033130L	Drive Shaft		36	59.5	40.5	794	
	2015.05-	6AT	F	L	MPV FWD DEDA		2032950L	Drive Shaft		36	59.5	40.5	486	
Altea														
1.2 (77 kw)	2010.04-	5MT/6MT	F	L	MPV FWD CBZB		2612010L	Drive Shaft		36	59.5	40	536	
	2010.04-	5MT/6MT	F	R	MPV FWD CBZB		2610960L	Drive Shaft		36	59.5	40	800	
1.4 (92 kw)	2007.11-	6MT	F	L	MPV FWD CAXC		2612010L	Drive Shaft		36	59.5	40	536	
	2007.11-	6MT	F	R	MPV FWD CAXC		2610960L	Drive Shaft		36	59.5	40	800	
1.6 (66 kw)	2010.05-	5MT	F	L	MPV FWD CAYB		2032940L	Drive Shaft		36	59.5	40	517	
	2010.05-	5MT	F	R	MPV FWD CAYB		2610420L	Drive Shaft		36	59.5	40	814	
1.6 (75 kw)	2004.04-	6MT	F	R	MPV FWD BGU/BSE/BSF/CCSA		2610960L	Drive Shaft		36	59.5	40	800	
	2004.04-	7DCT	F	L	MPV FWD BGU/BSE/BSF/CCSA		2032940L	Drive Shaft		36	59.5	40	517	
	2004.04-	7DCT	F	R	MPV FWD BGU/BSE/BSF/CCSA		2610420L	Drive Shaft		36	59.5	40	814	
	2009.12-	5MT	F	R	MPV FWD CHGA		2610960L	Drive Shaft		36	59.5	40	800	
	2010.11-2011.05	5MT	F	R	MPV FWD CMXA		2610960L	Drive Shaft		36	59.5	40	800	
1.6 (77 kw)	2009.11-	5MT	F	L	MPV FWD CAYC		2032940L	Drive Shaft		36	59.5	40	517	
	2009.11-	5MT	F	R	MPV FWD CAYC		2610420L	Drive Shaft		36	59.5	40	814	
	2009.11-	7DCT	F	L	MPV FWD CAYC		2612820L	Drive Shaft		36	59.5	40	523	
	2009.11-	7DCT	F	R	MPV FWD CAYC	Date To:2011.05	2033130L	Drive Shaft		36	59.5	40.5	794	
	2009.11-	7DCT	F	R	MPV FWD CAYC		2610960L	Drive Shaft		36	59.5	40	800	
1.8 (118 kw)	2007.01-	6MT	F	L	MPV FWD BYT/BZB/CDAA	Date To:2009.10;Date From:2010.05;Chassis no. from:5P-8-000001	2611000L	Drive Shaft		36	59.5	40.5	514	
	2007.01-	6MT	F	L	MPV FWD BYT/BZB/CDAA	Date From:2009.11;Date To:2010.05;Chassis no. to:5P-A-040000	2612820L	Drive Shaft		36	59.5	40	523	
	2007.01-	6MT	F	R	MPV FWD BYT/BZB/CDAA	Date From:2009.11;Date To:2010.05;Chassis no. to:5P-A-040000	2612830L	Drive Shaft		36	59.5	40	815	
	2007.01-	6MT	F	R	MPV FWD BYT/BZB/CDAA	Date To:2009.10;Date From:2010.05;Chassis no. from:5P-8-000001	2613410L	Drive Shaft		36	59.5	40.5	806	
	2007.01-	7DCT	F	L	MPV FWD BYT/BZB/CDAA		2611000L	Drive Shaft		36	59.5	40.5	514	
	2007.01-	7DCT	F	R	MPV FWD BYT/BZB/CDAA		2033130L	Drive Shaft		36	59.5	40.5	794	
	2007.01-	7DCT	F	R	MPV FWD BYT/BZB/CDAA		2032940L	Drive Shaft		36	59.5	40	517	
1.9 (66 kw)	2009.11-2010.12	5MT	F	L	MPV FWD BXF		2610420L	Drive Shaft		36	59.5	40	814	
	2009.11-2010.12	5MT	F	R	MPV FWD BXF		2032940L	Drive Shaft		36	59.5	40	517	
1.9 (77 kw)	2004.04-2010.12	5MT	F	L	MPV FWD BJB/BKC/BLS/BXE		2032940L	Drive Shaft		36	59.5	40	517	
	2004.04-2010.12	5MT	F	R	MPV FWD BJB/BKC/BLS/BXE		2610420L	Drive Shaft		36	59.5	40	814	
	2004.04-2010.12	6DCT	F	L	MPV FWD BJB/BKC/BLS/BXE	Date From:2008.01;Date To:2009.07;For taxis	2033810L	Drive Shaft		36	59.5	40	485	
	2004.04-2010.12	6DCT	F	L	MPV FWD BJB/BKC/BLS/BXE		2540130L	Drive Shaft		36	59.5	40.5	482	
	2004.04-2010.12	6DCT	F	R	MPV FWD BJB/BKC/BLS/BXE		2540110L	Drive Shaft		36	59.5	40.5	760	
2.0 (100 kw)	2004.04-2009.05	6DCT	F	L	MPV FWD AZV	For taxis,Date From:2008.01	2033810L	Drive Shaft		36	59.5	40	485	
	2004.04-2009.05	6DCT	F	L	MPV FWD AZV	For taxis,Date To:2007.12	2540130L	Drive Shaft		36	59.5	40.5	482	
	2004.04-2009.05	6DCT	F	R	MPV FWD AZV	For taxis	2540110L	Drive Shaft		36	59.5	40.5	760	
	2004.04-2009.05	6MT	F	L	MPV FWD AZV	Date To:2008.05;Chassis no. from:5P-5-047 001;chassis no. to:5P-6-100000	2032950L	Drive Shaft		36	59.5	40.5	486	
	2004.04-2009.05	6MT	F	R	MPV FWD AZV	Date To:2008.05;Chassis no. from:5P-5-047 001;chassis no. to:5P-6-100000	2033130L	Drive Shaft		36	59.5	40.5	794	
	2004.04-2009.05	6MT	F	L/R	MPV FWD AZV	chassis no. to:5P-5-047 000	2032950L	Drive Shaft		36	59.5	40.5	486	
	2004.04-2009.05	MT	F	R	MPV FWD AZV		2033800L	Drive Shaft		36	59.5	40	487	
2.0 (103 kw)	2004.03-	6DCT	F	L	MPV FWD BKD/CFHC	For taxis	2033810L	Drive Shaft		36	59.5	40	485	
	2004.03-	6DCT	F	L	MPV FWD BKD/CFHC		2540130L	Drive Shaft		36	59.5	40.5	482	
	2004.03-	6DCT	F	R	MPV FWD BKD/CFHC	Date from:2009.08,For taxis	2033540L	Drive Shaft		36	59.5	40	760	
	2004.03-	6DCT	F	R	MPV FWD BKD/CFHC		2540110L	Drive Shaft		36	59.5	40.5	760	
	2004.03-	6MT	F	L	MPV FWD BKD/CFHC		2032950L	Drive Shaft		36	59.5	40.5	486	
	2004.03-	6MT	F	R	MPV FWD BKD/CFHC	Date To:2008.05;Chassis no. from:5P-5-047 001;chassis no. to:5P-6-100000	2033130L	Drive Shaft		36	59.5	40.5	794	
	2004.03-	6MT	F	R	MPV FWD BKD/CFHC	Date From:2008.06;Chassis no. from:5P-7-000001	2033130L	Drive Shaft		36	59.5	40.5	794	





SEAT Altea	YEAR	TRANSM.	F/R	L/R	BODY STYLE & DRIVE TYPE & ENGINE	REMARKS	GSP Ref.	PRODUCT	ABS	Technical Specifications				
										A	B	C	H	L
2.0 (103 kw)	2005.11-2010.11	6DCT	F	L	MPV FWD BMM	Date From:2008.01	2033810L	Drive Shaft		36		59.5	40	485
	2005.11-2010.11	6DCT	F	L	MPV FWD BMM	Date To:2007.12	2540130L	Drive Shaft		36		59.5	40.5	482
	2005.11-2010.11	6DCT	F	R	MPV FWD BMM		2540110L	Drive Shaft		36		59.5	40.5	760
	2005.11-2010.11	6MT	F	L	MPV FWD BMM		2032950L	Drive Shaft		36		59.5	40.5	486
	2005.11-2010.11	6MT	F	R	MPV FWD BMM	Date From:2006.06;Chassis no. from:SP-6-100000	2033130L	Drive Shaft		36		59.5	40.5	794
	2005.11-2010.11	6MT	F	R	MPV FWD BMM	Date From:2006.06;Chassis no. from:SP-7-000001	2033130L	Drive Shaft		36		59.5	40.5	794
	2005.11-2010.11	6MT	F	R	MPV FWD BMM	Date From:2010.05;Chassis no. from:SP-8-000001;For taxis	2611470L	Drive Shaft		36		59.5	40.5	795
	2005.11-2010.11	MT	F	L	MPV FWD BMM		2033800L	Drive Shaft		36		59.5	40	487
	2010.10-	6MT	F	L	MPV 4WD CFHC		2032950L	Drive Shaft		36		59.5	40.5	486
	2010.10-	6MT	F	R	MPV 4WD CFHC		2032660L	Drive Shaft		36		59.5	40.5	601
	2010.10-	MT	F	R	MPV 4WD CFHC	not for taxis	2033130L	Drive Shaft		36		59.5	40.5	794
2.0 (110 kw)	2004.05-2009.03	6AT	F	R	MPV FWD BLR/BLY/BVY/BVZ		2610940L	Drive Shaft		36	26	59.5	40	884
	2004.05-2009.03	6MT	F	L	MPV FWD BLR/BLY/BVY/BVZ		2032940L	Drive Shaft		36		59.5	40	517
	2004.05-2009.03	6MT	F	R	MPV FWD BLR/BLY/BVY/BVZ		2610420L	Drive Shaft		36		59.5	40	814
2.0 (125 kw)	2005.11-2010.05	6MT	F	L	MPV FWD BMN/CEGA		2032950L	Drive Shaft		36		59.5	40.5	486
	2005.11-2010.05	6MT	F	R	MPV FWD BMN/CEGA		2033130L	Drive Shaft		36		59.5	40.5	794
	2005.11-2010.05	MT	F	L	MPV FWD BMN/CEGA		2033800L	Drive Shaft		36		59.5	40	487
2.0 (147 kw)	2006.02-2009.05	6DCT	F	R	MPV FWD BWA		2016530L	Drive Shaft		36		59.5	40.5	785
	2006.02-2009.05	6MT/6DCT	F	L	MPV FWD BWA		2032950L	Drive Shaft		36		59.5	40.5	486
	2006.02-2009.05	AT/MT	F	L	MPV FWD BWA		2033800L	Drive Shaft		36		59.5	40	487
Altea Freetrack														
1.6 (77 kw)	2010.02-	5MT	F	L	MPV FWD CAYC		2032940L	Drive Shaft		36		59.5	40	517
	2010.02-	5MT	F	R	MPV FWD CAYC		2610420L	Drive Shaft		36		59.5	40	814
	2010.02-	7DCT	F	L	MPV FWD CAYC		2612820L	Drive Shaft		36		59.5	40	523
	2010.02-	7DCT	F	R	MPV FWD CAYC	Date To:2011.05	2033130L	Drive Shaft		36		59.5	40.5	794
	2010.02-	7DCT	F	R	MPV FWD CAYC		2610960L	Drive Shaft		36		59.5	40	800
2.0 (103 kw)	2007.05-2010.11	6MT	F	L	MPV 4WD BMM		2032950L	Drive Shaft		36		59.5	40.5	486
	2007.05-2010.11	6MT	F	R	MPV 4WD BMM		2032660L	Drive Shaft		36		59.5	40.5	601
	2007.05-2010.11	MT	F	L	MPV 4WD BMM		2033800L	Drive Shaft		36		59.5	40	487
	2007.06-2010.11	6DCT	F	L	MPV FWD BMM	Date From:2008.01	2033810L	Drive Shaft		36		59.5	40	485
	2007.06-2010.11	6DCT	F	R	MPV FWD BMM	Date To:2007.12	2540130L	Drive Shaft		36		59.5	40.5	482
	2007.06-2010.11	6DCT	F	R	MPV FWD BMM		2540110L	Drive Shaft		36		59.5	40.5	760
	2007.06-2010.11	6MT	F	L	MPV FWD BMM		2032950L	Drive Shaft		36		59.5	40.5	486
	2007.06-2010.11	6MT	F	R	MPV FWD BMM		2033130L	Drive Shaft		36		59.5	40.5	794
	2007.06-2010.11	6MT	F	R	MPV FWD BMM	Date From:2010.05;Chassis no. from:SP-8-000001;For taxis	2611470L	Drive Shaft		36		59.5	40.5	795
	2007.06-2010.11	MT	F	L	MPV FWD BMM		2033800L	Drive Shaft		36		59.5	40	487
	2010.10-	6AT/6MT	F	L	MPV 4WD CFHC		2032950L	Drive Shaft		36		59.5	40.5	486
	2010.10-	6AT/6MT	F	R	MPV 4WD CFHC		2032660L	Drive Shaft		36		59.5	40.5	601
	2010.10-	AT/MT	F	L	MPV 4WD CFHC		2033800L	Drive Shaft		36		59.5	40	487
2.0 (125 kw)	2007.06-2013.06	6AT/6MT	F	L	MPV 4WD BMN/CEGA/CFJA		2032950L	Drive Shaft		36		59.5	40.5	486
	2007.06-2013.06	6AT/6MT	F	R	MPV 4WD BMN/CEGA/CFJA		2032660L	Drive Shaft		36		59.5	40.5	601
	2007.06-2013.06	MT	F	L	MPV 4WD BMN/CEGA/CFJA		2033800L	Drive Shaft		36		59.5	40	487
2.0 (147 kw)	2007.06-2009.05	6AT	F	L	MPV 4WD BWA		2032950L	Drive Shaft		36		59.5	40.5	486
	2007.06-2009.05	6AT	F	R	MPV 4WD BWA		2032660L	Drive Shaft		36		59.5	40.5	601
	2007.06-2009.05	AT/MT	F	L	MPV 4WD BWA		2033800L	Drive Shaft		36		59.5	40	487
	2007.06-2009.05	6AT/6MT	F	R	MPV FWD BWA	Date From:2007.06;Altea Freetrack	2032660L	Drive Shaft		36		59.5	40.5	601
	2007.06-2009.05	6DCT	F	R	MPV FWD BWA		2016530L	Drive Shaft		36		59.5	40.5	785
	2007.06-2009.05	6MT/6DCT	F	L	MPV FWD BWA		2032950L	Drive Shaft		36		59.5	40.5	486
	2007.06-2009.05	MT	F	L	MPV FWD BWA		2033800L	Drive Shaft		36		59.5	40	487
2.0 (155 kw)	2009.05-	6AT/6MT	F	L	MPV 4WD CCZB		2032950L	Drive Shaft		36		59.5	40.5	486
	2009.05-	6AT/6MT	F	R	MPV 4WD CCZB		2032660L	Drive Shaft		36		59.5	40.5	601
	2009.05-	AT/MT	F	L	MPV 4WD CCZB		2033800L	Drive Shaft		36		59.5	40	487
	2009.05-	6AT	F	L	MPV FWD CCZB		2032950L	Drive Shaft		36		59.5	40.5	486
	2009.05-	6AT	F	R	MPV FWD CCZB		2016530L	Drive Shaft		36		59.5	40.5	785
Altea XL														
1.2 (77 kw)	2010.05-	5MT/6MT	F	L	MPV FWD CBZB		2612010L	Drive Shaft		36		59.5	40	536
	2010.05-	5MT/6MT	F	R	MPV FWD CBZB		2610960L	Drive Shaft		36		59.5	40	800
1.4 (92 kw)	2007.11-	6MT	F	L	MPV FWD CAXC		2612010L	Drive Shaft		36		59.5	40	536
	2007.11-	6MT	F	R	MPV FWD CAXC		2610960L	Drive Shaft		36		59.5	40	800
1.6 (66 kw)	2010.11-	5MT	F	L	MPV FWD CAYB		2032940L	Drive Shaft		36		59.5	40	517
	2010.11-	5MT	F	R	MPV FWD CAYB		2610420L	Drive Shaft		36		59.5	40	814
1.6 (75 kw)	2006.10-	5MT	F	R	MPV FWD BSE/BSF/CCSA/CMXA		2610960L	Drive Shaft		36		59.5	40	800
	2006.10-	7AT	F	L	MPV FWD BSE/BSF/CCSA/CMXA		2032940L	Drive Shaft		36		59.5	40	517
	2006.10-	5MT	F	R	MPV FWD CHGA		2610960L	Drive Shaft		36		59.5	40	800
	2006.10-2010.11	6MT	F	R	MPV FWD BGL/BSE/BSF/CCSA		2610960L	Drive Shaft		36		59.5	40	800





 SEAT	 YEAR	TRANSM.	F/R	L/R	BODY STYLE & DRIVE TYPE & ENGINE	REMARKS	GSP Ref.	 PRODUCT	 ABS	Technical Specifications					
										A	B	C	H	L	
SEAT Altea XL 1.6 (75 kw)	2006.10-2010.11	7DCT	F	L	MPV FWD BGU/BSE/BSF/CCSA		2032940L	Drive Shaft		36		59.5	40	517	
	2006.10-2010.11	7DCT	F	R	MPV FWD BGU/BSE/BSF/CCSA		2610420L	Drive Shaft		36		59.5	40	814	
1.6 (77 kw)	2009.11-	5MT	F	L	MPV FWD CAYC		2032940L	Drive Shaft		36		59.5	40	517	
	2009.11-	5MT	F	R	MPV FWD CAYC		2610420L	Drive Shaft		36		59.5	40	814	
	2009.11-	7DCT	F	L	MPV FWD CAYC		2611000L	Drive Shaft		36		59.5	40.5	514	
	2009.11-	7DCT	F	L	MPV FWD CAYC		2612820L	Drive Shaft		36		59.5	40	523	
	2009.11-	7DCT	F	R	MPV FWD CAYC	Date to:2011.05	2033130L	Drive Shaft		36		59.5	40.5	794	
	2009.11-	7DCT	F	R	MPV FWD CAYC		2610960L	Drive Shaft		36		59.5	40	800	
1.8 (118 kw)	2007.01-	6MT	F	L	MPV FWD BYT/BZB/CDA	Date From:2010.05;chassis no. from:SP-B-00001;Date To:2009.10	2611000L	Drive Shaft		36		59.5	40.5	514	
	2007.01-	6MT	F	L	MPV FWD BYT/BZB/CDA	Date From:2009.11;Date To:2010.05;chassis no. to:SP-A-045000	2612820L	Drive Shaft		36		59.5	40	523	
	2007.01-	6MT	F	R	MPV FWD BYT/BZB/CDA	Date From:2009.11;Date To:2010.05;chassis no. to:SP-A-045000	2612830L	Drive Shaft		36		59.5	40	815	
	2007.01-	6MT	F	R	MPV FWD BYT/BZB/CDA	Date From:2010.05;chassis no. from:SP-B-00001;Date To:2009.10	2613410L	Drive Shaft		36		59.5	40.5	806	
	2007.01-	7DCT	F	L	MPV FWD BYT/BZB/CDA		2611000L	Drive Shaft		36		59.5	40.5	514	
	2007.01-	7DCT	F	R	MPV FWD BYT/BZB/CDA		2033130L	Drive Shaft		36		59.5	40.5	794	
	2007.01-	MT	F	L	MPV FWD BYT/BZB/CDA		2032940L	Drive Shaft		36		59.5	40	517	
1.9 (66 kw)	2009.08-2010.12	5MT	F	L	MPV FWD BXF		2032940L	Drive Shaft		36		59.5	40	517	
	2009.08-2010.12	5MT	F	R	MPV FWD BXF		2610420L	Drive Shaft		36		59.5	40	814	
1.9 (77 kw)	2006.05-2010.12	5MT	F	L	MPV FWD BKC/BLS/BXE		2032940L	Drive Shaft		36		59.5	40	517	
	2006.05-2010.12	5MT	F	R	MPV FWD BKC/BLS/BXE		2610420L	Drive Shaft		36		59.5	40	814	
	2006.05-2010.12	6DCT	F	L	MPV FWD BKC/BLS/BXE	Date From:2008.01;Date To:2009.07	2033810L	Drive Shaft		36		59.5	40	485	
	2006.05-2010.12	6DCT	F	L	MPV FWD BKC/BLS/BXE	Date To:2007.12	2540130L	Drive Shaft		36		59.5	40.5	482	
	2006.05-2010.12	6DCT	F	R	MPV FWD BKC/BLS/BXE		2540110L	Drive Shaft		36		59.5	40.5	760	
	2009.05-2010.09	6MT	F	L	MPV 4WD BLS		2032950L	Drive Shaft		36		59.5	40.5	486	
	2009.05-2010.09	6MT	F	R	MPV 4WD BLS		2032660L	Drive Shaft		36		59.5	40.5	601	
2.0 (100 kw)	2006.11-2009.05	6DCT	F	L	MPV FWD AZV	Date From:2008.01	2033810L	Drive Shaft		36		59.5	40	485	
	2006.11-2009.05	6DCT	F	L	MPV FWD AZV	Date To:2007.12	2540130L	Drive Shaft		36		59.5	40.5	482	
	2006.11-2009.05	6DCT	F	R	MPV FWD AZV		2540110L	Drive Shaft		36		59.5	40.5	760	
	2006.11-2009.05	6MT	F	L	MPV FWD AZV		2032950L	Drive Shaft		36		59.5	40.5	486	
	2006.11-2009.05	MT/6MT	F	R	MPV FWD AZV		2033130L	Drive Shaft		36		59.5	40.5	794	
	2006.05-	6DCT	F	L	MPV FWD BKD/CFHC	Date From:2008.01	2033810L	Drive Shaft		36		59.5	40	485	
2.0 (103 kw)	2006.05-	6DCT	F	L	MPV FWD BKD/CFHC	Date To:2007.12	2540130L	Drive Shaft		36		59.5	40.5	482	
	2006.05-	6DCT	F	R	MPV FWD BKD/CFHC		2540110L	Drive Shaft		36		59.5	40.5	760	
	2006.05-	6MT	F	L	MPV FWD BKD/CFHC		2032950L	Drive Shaft		36		59.5	40.5	486	
	2006.05-	6MT	F	R	MPV FWD BKD/CFHC		2033130L	Drive Shaft		36		59.5	40.5	794	
	2006.05-	6MT	F	R	MPV FWD BKD/CFHC	Date From:2010.05;Chassis no. from:SP-B-00001;For taxi	2611470L	Drive Shaft		36		59.5	40.5	795	
	2006.05-	MT	F	L	MPV FWD BKD/CFHC		2033800L	Drive Shaft		36		59.5	40	487	
	2006.10-2010.11	6DCT	F	L	MPV FWD BMM	Date From:2008.01	2033810L	Drive Shaft		36		59.5	40	485	
	2006.10-2010.11	6DCT	F	L	MPV FWD BMM	Date To:2007.12	2540130L	Drive Shaft		36		59.5	40.5	482	
	2006.10-2010.11	6DCT	F	R	MPV FWD BMM		2540110L	Drive Shaft		36		59.5	40.5	760	
	2006.10-2010.11	6MT	F	L	MPV FWD BMM		2032950L	Drive Shaft		36		59.5	40.5	486	
	2006.10-2010.11	6MT	F	R	MPV FWD BMM		2033130L	Drive Shaft		36		59.5	40.5	794	
	2006.10-2010.11	6MT	F	R	MPV FWD BMM	Date From:2010.05;Chassis no. from:SP-B-00001;For taxi	2611470L	Drive Shaft		36		59.5	40.5	795	
	2006.10-2010.11	MT	F	L	MPV FWD BMM		2033800L	Drive Shaft		36		59.5	40	487	
	2007.06-2010.11	6MT	F	L	MPV 4WD BMM		2032950L	Drive Shaft		36		59.5	40.5	486	
	2007.06-2010.11	6MT	F	R	MPV 4WD BMM		2032660L	Drive Shaft		36		59.5	40.5	601	
	2007.06-2010.11	MT	F	L	MPV 4WD BMM		2033800L	Drive Shaft		36		59.5	40	487	
	2010.09-	6AT/6MT	F	L	MPV 4WD CFHC		2032950L	Drive Shaft		36		59.5	40.5	486	
	2010.09-	6AT/6MT	F	R	MPV 4WD CFHC		2032660L	Drive Shaft		36		59.5	40.5	601	
	2010.09-	AT/MT	F	L	MPV 4WD CFHC		2033800L	Drive Shaft		36		59.5	40	487	
	2.0 (110 kw)	2006.10-2009.03	6AT	F	R	MPV FWD BVY/BVZ		2610940L	Drive Shaft		36	26	59.5	40	884
		2006.10-2009.03	6MT	F	L	MPV FWD BVY/BVZ		2032940L	Drive Shaft		36		59.5	40	517
		2006.10-2009.03	6MT	F	R	MPV FWD BVY/BVZ		2610420L	Drive Shaft		36		59.5	40	814
	2.0 (125 kw)	2007.06-2009.05	6AT/6MT	F	L	MPV 4WD BMN		2032950L	Drive Shaft		36		59.5	40.5	486
2007.06-2009.05		6AT/6MT	F	R	MPV 4WD BMN		2032660L	Drive Shaft		36		59.5	40.5	601	
2007.06-2009.05		MT	F	L	MPV 4WD BMN		2033800L	Drive Shaft		36		59.5	40	487	
2007.06-2010.05		6MT	F	L	MPV FWD BMN/CEGA		2032950L	Drive Shaft		36		59.5	40.5	486	
2007.06-2010.05		6MT	F	R	MPV FWD BMN/CEGA		2033130L	Drive Shaft		36		59.5	40.5	794	
2007.06-2010.05		6MT	F	R	MPV FWD BMN/CEGA	Date From:2010.05;Chassis no. from:SP-B-00001;For taxi	2611470L	Drive Shaft		36		59.5	40.5	795	
2007.06-2010.05		AT	F	R	MPV FWD BMN/CEGA	Date To:2010.12	2540110L	Drive Shaft		36		59.5	40.5	760	
2007.06-2010.05		MT	F	L	MPV FWD BMN/CEGA		2033800L	Drive Shaft		36		59.5	40	487	
2007.06-2010.05		6AT/6MT	F	R	MPV FWD BWA	Date From:2007.06;Altea Freetrack	2032660L	Drive Shaft		36		59.5	40.5	601	
2.0 (147 kw)	2006.10-2009.05	6DCT	F	R	MPV FWD BWA		2016530L	Drive Shaft		36		59.5	40.5	785	
	2006.10-2009.05	6MT/6DCT	F	L	MPV FWD BWA		2032950L	Drive Shaft		36		59.5	40.5	486	
	2006.10-2009.05	MT	F	L	MPV FWD BWA		2033800L	Drive Shaft		36		59.5	40	487	
	2007.06-2009.05	6AT	F	L	MPV 4WD BWA		2032950L	Drive Shaft		36		59.5	40.5	486	





		TRANSM.	F/R	L/R	BODY STYLE & DRIVE TYPE & ENGINE	REMARKS	GSP Ref.		PRODUCT	ABS	Technical Specifications				
											A	B	C	H	L
SEAT															
Altea XL															
2.0 (147 kw)	2007.06-2009.05	6AT	F	R	MPV 4WD BWA		203266OL	Drive Shaft		36		59.5	40.5	601	
	2007.06-2009.05	AT/MT	F	L	MPV 4WD BWA		203380OL	Drive Shaft		36		59.5	40	487	
Ateca															
1.4 (110 kw)	2016.06-	6MT	F	L	SUV 4WD CZEA		201896OL	Drive Shaft		36		59.5	40	500	
1.6 (85 kw)	2016.04-	6MT	F	L	SUV FWD DDYA/DGTE		261201OL	Drive Shaft		36		59.5	40	536	
2.0 (81 kw)	2016.10-	6MT	F	L	SUV FWD CRVA		261201OL	Drive Shaft		36		59.5	40	536	
2.0 (110 kw)	2016.04-	6MT	F	L	SUV FWD DFFA/DTTA/DTTC		261100OL	Drive Shaft		36		59.5	40.5	514	
	2016.04-	6MT	F	R	SUV FWD DFFA/DTTA/DTTC		261341OL	Drive Shaft		36		59.5	40.5	806	
	2016.04-	7DCT	F	L	SUV FWD DFFA/DTTA/DTTC		202351OL	Drive Shaft		36	37	59.5	40	570	
	2016.04-	7DCT	F	R	SUV FWD DFFA/DTTA/DTTC		203613OL	Drive Shaft		36	37	59.5	40	921	
	2016.06-	7AT/6MT	F	L	SUV 4WD DFFA/DTTA/DTTC		201896OL	Drive Shaft		36		59.5	40	500	
2.0 (140 kw)	2016.06-	7AT/6MT	F	R	SUV 4WD DFFA/DTTA/DTTC		201889OL	Drive Shaft		36		59.5	40	614	
	2016.06-	7AT	F	L	SUV 4WD DFHA		202351OL	Drive Shaft		36	37	59.5	40	570	
	2017.05-	7AT	F	R	SUV 4WD CZPB/DKZA/DNNA		201889OL	Drive Shaft		36		59.5	40	614	
Ibiza SC															
1.2 (77 kw)	2010.09-2015.05	7AT	F	L	Hatchback FWD CBZB		261201OL	Drive Shaft		36		59.5	40	536	
Leon															
1.2 (63 kw)	2013.01-2018.08	5MT	F	L	Hatchback FWD CJZB/CYVA	For PR code:1PA/1PE/2H4	203373OL	Drive Shaft		36		59.5	40	517	
	2013.01-2018.08	5MT	F	R	Hatchback FWD CJZB/CYVA		261096OL	Drive Shaft		36		59.5	40	800	
	2013.01-2018.08	MT	F	L	Hatchback FWD CJZB/CYVA		203294OL	Drive Shaft		36		59.5	40	517	
	2013.01-2018.08	MT	F	R	Hatchback FWD CJZB/CYVA		261042OL	Drive Shaft		36		59.5	40	814	
	2013.01-2018.08	MT	F	R	Hatchback FWD CJZB/CYVA		261307OL	Drive Shaft		36		59.5	40	820	
	2013.01-2018.08	5MT	F	R	Hatchback Van FWD CJZB/CYVA		261096OL	Drive Shaft		36		59.5	40	800	
	2013.01-2018.08	MT	F	L	Hatchback Van FWD CJZB/CYVA		203294OL	Drive Shaft		36		59.5	40	517	
	2013.01-2018.08	MT	F	R	Hatchback Van FWD CJZB/CYVA		261042OL	Drive Shaft		36		59.5	40	814	
1.2 (77 kw)	2010.02-2013.08	5MT/6MT	F	L	Hatchback FWD CBZB		261201OL	Drive Shaft		36		59.5	40	536	
	2010.02-2013.08	5MT/6MT	F	R	Hatchback FWD CBZB		261096OL	Drive Shaft		36		59.5	40	800	
	2013.01-2020.08	5MT/6MT	F	L	Hatchback FWD CJZA		203373OL	Drive Shaft		36		59.5	40	517	
	2013.01-2020.08	5MT/6MT	F	R	Hatchback FWD CJZA		261307OL	Drive Shaft		36		59.5	40	820	
	2013.01-2020.08	7DCT	F	L	Hatchback FWD CJZA		261282OL	Drive Shaft		36		59.5	40	523	
	2013.01-2020.08	7DCT	F	R	Hatchback FWD CJZA		261096OL	Drive Shaft		36		59.5	40	800	
	2013.01-2020.08	MT	F	L	Hatchback FWD CJZA		203294OL	Drive Shaft		36		59.5	40	517	
1.2 (81 kw)	2013.01-2020.08	MT	F	R	Hatchback FWD CJZA		261042OL	Drive Shaft		36		59.5	40	814	
	2014.04-2018.08	6MT	F	L	Hatchback Van FWD CYVB		203373OL	Drive Shaft		36		59.5	40	517	
	2014.04-2018.08	6MT	F	R	Hatchback Van FWD CYVB		261307OL	Drive Shaft		36		59.5	40	820	
	2014.04-2018.08	7DCT	F	L	Hatchback Van FWD CYVB		261282OL	Drive Shaft		36		59.5	40	523	
	2014.04-2018.08	7DCT	F	R	Hatchback Van FWD CYVB		261096OL	Drive Shaft		36		59.5	40	800	
	2014.04-2020.08	5MT/6MT	F	L	Hatchback FWD CYVB		203373OL	Drive Shaft		36		59.5	40	517	
	2014.04-2020.08	5MT/6MT	F	R	Hatchback FWD CYVB		261307OL	Drive Shaft		36		59.5	40	820	
	2014.04-2020.08	7DCT	F	L	Hatchback FWD CYVB		261282OL	Drive Shaft		36		59.5	40	523	
1.4 (81 kw)	2014.04-2020.08	7DCT	F	R	Hatchback FWD CYVB		261096OL	Drive Shaft		36		59.5	40	800	
	2013.11-2018.08	6MT	F	R	Hatchback FWD CPWA		261307OL	Drive Shaft		36		59.5	40	820	
	2013.11-2018.08	6MT/7DCT	F	L	Hatchback FWD CPWA		261282OL	Drive Shaft		36		59.5	40	523	
	2013.11-2018.08	7DCT	F	R	Hatchback FWD CPWA		261096OL	Drive Shaft		36		59.5	40	800	
1.4 (90 kw)	2013.11-2018.08	MT	F	L	Hatchback FWD CPWA		203373OL	Drive Shaft		36		59.5	40	517	
	2012.09-2016.10	6MT	F	L	Hatchback FWD CMBA/CXSA		261282OL	Drive Shaft		36		59.5	40	523	
	2012.09-2016.10	6MT	F	R	Hatchback FWD CMBA/CXSA		261307OL	Drive Shaft		36		59.5	40	820	
	2012.09-2016.10	6MT	F	L	Hatchback Van FWD CMBA/CXSA		261282OL	Drive Shaft		36		59.5	40	523	
1.4 (92 kw)	2012.09-2016.10	6MT	F	R	Hatchback Van FWD CMBA/CXSA		261307OL	Drive Shaft		36		59.5	40	820	
	2007.11-2013.08	6MT	F	L	Hatchback FWD CAXC		261201OL	Drive Shaft		36		59.5	40	536	
	2007.11-2013.08	6MT	F	R	Hatchback FWD CAXC		261096OL	Drive Shaft		36		59.5	40	800	
	2014.05-2020.08	6MT	F	L	Hatchback FWD CZCA		261282OL	Drive Shaft		36		59.5	40	523	
1.4 (103 kw)	2014.05-2020.08	6MT	F	R	Hatchback FWD CZCA		261307OL	Drive Shaft		36		59.5	40	820	
	2012.09-2016.10	6MT	F	L	Hatchback Van FWD CHPA/CPTA		261282OL	Drive Shaft		36		59.5	40	523	
	2012.09-2016.10	6MT	F	R	Hatchback Van FWD CHPA/CPTA	Trans. code:MQ250	261283OL	Drive Shaft		36		59.5	40	815	
	2012.09-2016.10	6MT	F	R	Hatchback Van FWD CHPA/CPTA	For Engine Code:CHPA,Trans. code:MQ200	261307OL	Drive Shaft		36		59.5	40	820	
	2012.09-2020.08	6MT	F	L	Hatchback FWD CHPA/CPTA	For Engine Code:CHPA,Trans. code:MQ200/MQ250	261282OL	Drive Shaft		36		59.5	40	523	
	2012.09-2020.08	6MT	F	R	Hatchback FWD CHPA/CPTA	For Engine Code:CHPA,Trans. code:MQ250	261283OL	Drive Shaft		36		59.5	40	815	
	2012.09-2020.08	6MT	F	R	Hatchback FWD CHPA/CPTA	For Engine Code:CHPA,Trans. code:MQ200	261307OL	Drive Shaft		36		59.5	40	820	
	2012.09-2020.08	6MT	F	R	Hatchback FWD CHPA/CPTA	For Engine Code:CHPA,Trans. code:MQ200	261307OL	Drive Shaft		36		59.5	40	820	
	2012.09-2020.08	7DCT	F	L	Hatchback FWD CHPA/CPTA	For Engine Code:CHPA/CPTA	261100OL	Drive Shaft		36		59.5	40.5	514	
	2012.09-2020.08	7DCT	F	R	Hatchback FWD CHPA/CPTA	For Engine Code:CHPA/CPTA	203313OL	Drive Shaft		36		59.5	40.5	794	
1.4 (110 kw)	2012.09-2020.08	MT	F	L	Hatchback FWD CHPA/CPTA		203294OL	Drive Shaft		36		59.5	40	517	
	2014.05-2020.08	6MT	F	L	Hatchback FWD CZDA/CZEA		261282OL	Drive Shaft		36		59.5	40	523	
	2014.05-2020.08	6MT	F	R	Hatchback FWD CZDA/CZEA		261283OL	Drive Shaft		36		59.5	40	815	
	2014.05-2020.08	7DCT	F	L	Hatchback FWD CZDA/CZEA		261100OL	Drive Shaft		36		59.5	40.5	514	





 YEAR	TRANSM.	F/R	L/R	BODY STYLE & DRIVE TYPE & ENGINE	REMARKS	GSP Ref.	 PRODUCT	ABS	Technical Specifications				
									A	B	C	H	L
SEAT Leon													
1.4 (110 kw)	2014.05-2020.08	7DCT	F	R	Hatchback FWD CZDA/CZEA		2033130L	Drive Shaft	36	59.5	40.5	794	
	2014.05-2020.08	6MT	F	L	Hatchback Van FWD CZEA		2612820L	Drive Shaft	36	59.5	40	523	
	2014.05-2020.08	6MT	F	R	Hatchback Van FWD CZEA		2612830L	Drive Shaft	36	59.5	40	815	
	2014.05-2020.08	7DCT	F	L	Hatchback Van FWD CZEA		2611000L	Drive Shaft	36	59.5	40.5	514	
	2014.05-2020.08	7DCT	F	R	Hatchback Van FWD CZEA		2033130L	Drive Shaft	36	59.5	40.5	794	
1.5 (96 kw)	2018.10-2020.08	7DCT	F	L	Hatchback FWD DHFA		2611000L	Drive Shaft	36	59.5	40.5	514	
	2018.09-2020.08	6MT	F	L	Hatchback FWD DADA/DPCA		2612820L	Drive Shaft	36	59.5	40	523	
1.5 (110 kw)	2018.09-2020.08	7DCT	F	L	Hatchback FWD DADA/DPCA		2611000L	Drive Shaft	36	59.5	40.5	514	
	2019.11-	7AT	F	L	Hatchback FWD DFYA		2611000L	Drive Shaft	36	59.5	40.5	514	
	2010.11-2013.08	5MT	F	L	Hatchback FWD CAYB		2032940L	Drive Shaft	36	59.5	40	517	
1.6 (66 kw)	2010.11-2013.08	5MT	F	R	Hatchback FWD CAYB		2610420L	Drive Shaft	36	59.5	40	814	
	2010.11-2013.08	5MT	F	R	Hatchback FWD CAYB		2612830L	Drive Shaft	36	59.5	40	815	
	2012.11-2016.10	5MT	F	L	Hatchback Van FWD CLHB		2032940L	Drive Shaft	36	59.5	40	517	
	2012.11-2016.10	5MT	F	R	Hatchback Van FWD CLHB		2610420L	Drive Shaft	36	59.5	40	814	
	2012.11-2016.10	5MT	F	R	Hatchback Van FWD CLHB		2612830L	Drive Shaft	36	59.5	40	815	
	2012.11-2018.08	5MT	F	L	Hatchback FWD CLHB/CXXA/DDYB		2032940L	Drive Shaft	36	59.5	40	517	
	2012.11-2018.08	5MT	F	R	Hatchback FWD CLHB/CXXA/DDYB		2610420L	Drive Shaft	36	59.5	40	814	
	2012.11-2018.08	5MT	F	R	Hatchback FWD CLHB/CXXA/DDYB		2612830L	Drive Shaft	36	59.5	40	815	
	2005.07-2012.12	5MT	F	R	Hatchback FWD BSE/BSF/CCSA		2610960L	Drive Shaft	36	59.5	40	800	
	2005.07-2012.12	7DCT	F	L	Hatchback FWD BSE/BSF/CCSA		2032940L	Drive Shaft	36	59.5	40	517	
1.6 (75 kw)	2005.07-2012.12	7DCT	F	R	Hatchback FWD BSE/BSF/CCSA		2610420L	Drive Shaft	36	59.5	40	814	
	2005.07-2013.08	5MT	F	R	Hatchback FWD BSE/CCSA/CMXA		2610960L	Drive Shaft	36	59.5	40	800	
	2009.12-2013.08	5MT	F	R	Hatchback FWD CHGA		2610960L	Drive Shaft	36	59.5	40	800	
	2010.02-2013.08	5MT	F	L	Hatchback FWD CAYC	Date to:2011.05	2032940L	Drive Shaft	36	59.5	40	517	
1.6 (77 kw)	2010.02-2013.08	5MT	F	R	Hatchback FWD CAYC	Date to:2011.05	2610420L	Drive Shaft	36	59.5	40	814	
	2010.02-2013.08	5MT	F	R	Hatchback FWD CAYC	Date from:2011.06	2612830L	Drive Shaft	36	59.5	40	815	
	2010.02-2013.08	5MT/7DCT	F	L	Hatchback FWD CAYC	Date from:2011.06	2612820L	Drive Shaft	36	59.5	40	523	
	2010.02-2013.08	7DCT	F	L	Hatchback FWD CAYC	Date to:2011.05	2611000L	Drive Shaft	36	59.5	40.5	514	
	2010.02-2013.08	7DCT	F	R	Hatchback FWD CAYC	Date to:2011.05	2033130L	Drive Shaft	36	59.5	40.5	794	
	2010.02-2013.08	7DCT	F	R	Hatchback FWD CAYC	Date from:2011.06	2610960L	Drive Shaft	36	59.5	40	800	
	2012.09-2016.10	5MT	F	R	Hatchback Van FWD CLHA		2612830L	Drive Shaft	36	59.5	40	815	
	2012.09-2016.10	5MT/7DCT	F	L	Hatchback Van FWD CLHA		2612820L	Drive Shaft	36	59.5	40	523	
	2012.09-2016.10	7DCT	F	R	Hatchback Van FWD CLHA		2610960L	Drive Shaft	36	59.5	40	800	
	2012.09-2020.08	5MT	F	R	Hatchback FWD CLHA		2610420L	Drive Shaft	36	59.5	40	814	
	2012.09-2020.08	5MT	F	R	Hatchback FWD CLHA		2612830L	Drive Shaft	36	59.5	40	815	
	2012.09-2020.08	5MT/7DCT	F	L	Hatchback FWD CLHA		2612820L	Drive Shaft	36	59.5	40	523	
	2012.09-2020.08	7DCT	F	R	Hatchback FWD CLHA		2610960L	Drive Shaft	36	59.5	40	800	
	2012.09-2020.08	MT	F	L	Hatchback FWD CLHA		2032940L	Drive Shaft	36	59.5	40	517	
	1.6 (81 kw)	2013.09-2016.10	5MT/6MT	F	R	Hatchback Van FWD CRKB/CXXB/DBKA		2612830L	Drive Shaft	36	59.5	40	815
		2013.09-2016.10	5MT/6MT/7DCT	F	L	Hatchback Van FWD CRKB/CXXB/DBKA		2612820L	Drive Shaft	36	59.5	40	523
		2013.09-2016.10	7DCT	F	R	Hatchback Van FWD CRKB/CXXB/DBKA		2610960L	Drive Shaft	36	59.5	40	800
2013.09-2020.08		5MT/6MT	F	R	Hatchback FWD CRKB/CXXB/DBKA		2612830L	Drive Shaft	36	59.5	40	815	
2013.09-2020.08		5MT/6MT/7DCT	F	L	Hatchback FWD CRKB/CXXB/DBKA		2612820L	Drive Shaft	36	59.5	40	523	
2013.09-2020.08		7DCT	F	R	Hatchback FWD CRKB/CXXB/DBKA		2610960L	Drive Shaft	36	59.5	40	800	
2013.09-2020.08			F	L	Hatchback FWD CRKB/CXXB/DBKA		2032940L	Drive Shaft	36	59.5	40	517	
1.6 (85 kw)	2016.11-2020.08	5MT	F	R	Hatchback FWD DDYA/DGTE		2610420L	Drive Shaft	36	59.5	40	814	
	2016.11-2020.08	5MT	F	R	Hatchback FWD DDYA/DGTE		2612830L	Drive Shaft	36	59.5	40	815	
	2016.11-2020.08	5MT/6MT/7DCT	F	L	Hatchback FWD DDYA/DGTE		2612820L	Drive Shaft	36	59.5	40	523	
	2016.11-2020.08	7DCT	F	R	Hatchback FWD DDYA/DGTE		2610960L	Drive Shaft	36	59.5	40	800	
	2016.11-2020.08	5MT	F	R	Hatchback Van FWD DDYA		2610420L	Drive Shaft	36	59.5	40	814	
	2016.11-2020.08	5MT	F	R	Hatchback Van FWD DDYA		2612830L	Drive Shaft	36	59.5	40	815	
	2016.11-2020.08	5MT/7DCT	F	L	Hatchback Van FWD DDYA		2612820L	Drive Shaft	36	59.5	40	523	
	2016.11-2020.08	7DCT	F	R	Hatchback Van FWD DDYA		2610960L	Drive Shaft	36	59.5	40	800	
1.8 (118 kw)	2007.07-2013.08	6MT	F	L	Hatchback FWD BZB/CDAA	Date To:2009.11	2611000L	Drive Shaft	36	59.5	40.5	514	
	2007.07-2013.08	6MT	F	L	Hatchback FWD BZB/CDAA	Date From:2009.12	2612820L	Drive Shaft	36	59.5	40	523	
	2007.07-2013.08	6MT	F	R	Hatchback FWD BZB/CDAA		2613410L	Drive Shaft	36	59.5	40.5	806	
	2007.07-2013.08	7DCT	F	R	Hatchback FWD BZB/CDAA		2033130L	Drive Shaft	36	59.5	40.5	794	
1.8 (132 kw)	2013.02-2018.08	6MT	F	L	Hatchback FWD CJSA		2611000L	Drive Shaft	36	59.5	40.5	514	
	2013.02-2018.08	6MT	F	L	Hatchback Van FWD CJSA		2611000L	Drive Shaft	36	59.5	40.5	514	
1.9 (66 kw)	2007.06-2010.12	5MT	F	L	Hatchback FWD BXF		2032940L	Drive Shaft	36	59.5	40	517	
	2007.06-2010.12	5MT	F	R	Hatchback FWD BXF		2610420L	Drive Shaft	36	59.5	40	814	
1.9 (77 kw)	2005.07-2010.12	5MT	F	L	Hatchback FWD BKC/BLS/BXE	To Chassis:1P_8_093000:From Chassis:1P_8_093001	2032940L	Drive Shaft	36	59.5	40	517	
	2005.07-2010.12	5MT	F	R	Hatchback FWD BKC/BLS/BXE		2610420L	Drive Shaft	36	59.5	40	814	
	2005.07-2010.12	6DCT	F	L	Hatchback FWD BKC/BLS/BXE		2540130L	Drive Shaft	36	59.5	40.5	482	
	2005.07-2010.12	6DCT	F	R	Hatchback FWD BKC/BLS/BXE		2540110L	Drive Shaft	36	59.5	40.5	760	





		TRANSM.	F/R	L/R	BODY STYLE & DRIVE TYPE & ENGINE	REMARKS	GSP Ref.		ABS	Technical Specifications				
										A	B	C	H	L
SEAT Leon														
2.0 (81 kw)	2013.05-2020.08	5MT	F	L	Hatchback FWD CRLD/CRVA		261282OL	Drive Shaft		36		59.5	40	523
	2013.05-2020.08	5MT	F	R	Hatchback FWD CRLD/CRVA		261283OL	Drive Shaft		36		59.5	40	815
	2013.05-2020.08		F	L	Hatchback FWD CRLD/CRVA		203294OL	Drive Shaft		36		59.5	40	517
2.0 (100 kw)	2005.07-2010.05	6DCT	F	L	Hatchback FWD AZV		254013OL	Drive Shaft		36		59.5	40.5	482
	2005.07-2010.05	6DCT	F	R	Hatchback FWD AZV		254011OL	Drive Shaft		36		59.5	40.5	760
	2005.07-2010.05	6MT	F	L	Hatchback FWD AZV		203295OL	Drive Shaft		36		59.5	40.5	486
	2005.07-2010.05	6MT	F	R	Hatchback FWD AZV		203313OL	Drive Shaft		36		59.5	40.5	794
	2005.07-2010.05	MT	F	R	Hatchback FWD AZV		203380OL	Drive Shaft		36		59.5	40	487
2.0 (103 kw)	2005.07-2013.08	6DCT	F	L	Hatchback FWD BKD/CFHC/CLCB		254013OL	Drive Shaft		36		59.5	40.5	482
	2005.07-2013.08	6DCT	F	R	Hatchback FWD BKD/CFHC/CLCB		254011OL	Drive Shaft		36		59.5	40.5	760
	2005.07-2013.08	6MT	F	L	Hatchback FWD BKD/CFHC/CLCB		203295OL	Drive Shaft		36		59.5	40.5	486
	2005.07-2013.08	6MT	F	R	Hatchback FWD BKD/CFHC/CLCB		203313OL	Drive Shaft		36		59.5	40.5	794
	2005.07-2013.08	MT	F	R	Hatchback FWD BKD/CFHC/CLCB		203380OL	Drive Shaft		36		59.5	40	487
	2005.10-2010.10	6DCT	F	L	Hatchback FWD BMM		254013OL	Drive Shaft		36		59.5	40.5	482
	2005.10-2010.10	6DCT	F	R	Hatchback FWD BMM		254011OL	Drive Shaft		36		59.5	40.5	760
	2005.10-2010.10	6MT	F	L	Hatchback FWD BMM		203295OL	Drive Shaft		36		59.5	40.5	486
	2005.10-2010.10	6MT	F	R	Hatchback FWD BMM		203313OL	Drive Shaft		36		59.5	40.5	794
2.0 (105 kw)	2013.04-2020.08	6MT	F	R	Hatchback FWD CRVC		203313OL	Drive Shaft		36		59.5	40.5	794
	2013.04-2020.08	AT	F	L	Hatchback FWD CRVC		261285OL	Drive Shaft		36		59.5	40	472
	2013.04-2020.08	AT	F	R	Hatchback FWD CRVC		203354OL	Drive Shaft		36		59.5	40	760
2.0 (110 kw)	2005.07-2010.05	6AT	F	R	Hatchback FWD BLR/BLY/BVY/BVZ		261094OL	Drive Shaft		36	26	59.5	40	884
	2005.07-2010.05	6MT	F	L	Hatchback FWD BLR/BLY/BVY/BVZ		203294OL	Drive Shaft		36		59.5	40	517
	2005.07-2010.05	6MT	F	R	Hatchback FWD BLR/BLY/BVY/BVZ		261042OL	Drive Shaft		36		59.5	40	814
	2012.10-2018.08	6DCT	F	L	Hatchback Van FWD CKFC/CRMB		261285OL	Drive Shaft		36		59.5	40	472
	2012.10-2018.08	6DCT	F	R	Hatchback Van FWD CKFC/CRMB		203354OL	Drive Shaft		36		59.5	40	760
	2012.10-2018.08	6MT	F	R	Hatchback Van FWD CKFC/CRMB		203313OL	Drive Shaft		36		59.5	40.5	794
	2012.10-2020.08	6DCT	F	L	Hatchback FWD CKFC/CRMB/DFFA/DFGA		261285OL	Drive Shaft		36		59.5	40	472
	2012.10-2020.08	6DCT	F	R	Hatchback FWD CKFC/CRMB/DFFA/DFGA		203354OL	Drive Shaft		36		59.5	40	760
	2012.10-2020.08	6MT	F	L	Hatchback FWD CKFC/CRMB/DFFA/DFGA	For taxis	203295OL	Drive Shaft		36		59.5	40.5	486
	2012.10-2020.08	6MT	F	R	Hatchback FWD CKFC/CRMB/DFFA/DFGA		203313OL	Drive Shaft		36		59.5	40.5	794
	2012.10-2020.08	7DCT	F	L	Hatchback FWD CKFC/CRMB/DFFA/DFGA		201265OL	Drive Shaft		36	37	59.5	40	558
2.0 (125 kw)	2006.05-2013.08	6DCT	F	L	Hatchback FWD BMN/CEGA/CFJA		203381OL	Drive Shaft		36		59.5	40	485
	2006.05-2013.08	6DCT	F	L	Hatchback FWD BMN/CEGA/CFJA		254013OL	Drive Shaft		36		59.5	40.5	482
	2006.05-2013.08	6DCT	F	R	Hatchback FWD BMN/CEGA/CFJA		254011OL	Drive Shaft		36		59.5	40.5	760
	2006.05-2013.08	6MT	F	L	Hatchback FWD BMN/CEGA/CFJA		203295OL	Drive Shaft		36		59.5	40.5	486
	2006.05-2013.08	6MT	F	R	Hatchback FWD BMN/CEGA/CFJA		203313OL	Drive Shaft		36		59.5	40.5	794
	2006.05-2013.08	MT	F	L	Hatchback FWD BMN/CEGA/CFJA		203380OL	Drive Shaft		36		59.5	40	487
2.0 (135 kw)	2013.02-2018.08	6DCT	F	L	Hatchback Van FWD CUNA/CUPA		261285OL	Drive Shaft		36		59.5	40	472
	2013.02-2018.08	6DCT	F	R	Hatchback Van FWD CUNA/CUPA		203354OL	Drive Shaft		36		59.5	40	760
	2013.02-2020.08	6DCT	F	L	Hatchback FWD CUNA/CUPA/DJGA		261285OL	Drive Shaft		36		59.5	40	472
	2013.02-2020.08	6DCT	F	R	Hatchback FWD CUNA/CUPA/DJGA		203354OL	Drive Shaft		36		59.5	40	760
	2013.02-2020.08	6MT	F	L	Hatchback FWD CUNA/CUPA/DJGA		203295OL	Drive Shaft		36		59.5	40.5	486
	2013.02-2020.08	6MT	F	R	Hatchback FWD CUNA/CUPA/DJGA	Date from:2016.03	203313OL	Drive Shaft		36		59.5	40.5	794
2.0 (136 kw)	2005.10-2006.05	6DCT	F	R	Hatchback FWD BWA		201653OL	Drive Shaft		36		59.5	40.5	785
	2005.10-2006.05	6MT/6DCT	F	L	Hatchback FWD BWA		203295OL	Drive Shaft		36		59.5	40.5	486
	2005.10-2006.05	MT/6DCT	F	L	Hatchback FWD BWA		203380OL	Drive Shaft		36		59.5	40	487
2.0 (147 kw)	2005.05-2009.03	6DCT	F	L	Hatchback FWD BWA		203380OL	Drive Shaft		36		59.5	40	487
	2005.05-2009.03	6DCT	F	R	Hatchback FWD BWA		201653OL	Drive Shaft		36		59.5	40.5	785
	2005.05-2009.03	6MT	F	L	Hatchback FWD BWA		203295OL	Drive Shaft		36		59.5	40.5	486
2.0 (155 kw)	2009.06-2013.08	6DCT	F	R	Hatchback FWD CCZB		201653OL	Drive Shaft		36		59.5	40.5	785
	2009.06-2013.08	6MT	F	R	Hatchback FWD CCZB		261147OL	Drive Shaft		36		59.5	40.5	795
	2009.06-2013.08	6MT/6DCT	F	L	Hatchback FWD CCZB		203295OL	Drive Shaft		36		59.5	40.5	486
	2009.06-2013.08	MT/Semi-AT	F	L	Hatchback FWD CCZB		203380OL	Drive Shaft		36		59.5	40	487
2.0 (177 kw)	2006.11-2011.05	6MT	F	L	Hatchback FWD BWJ/CDLD		203295OL	Drive Shaft		36		59.5	40.5	486
	2006.11-2011.05	MT	F	L	Hatchback FWD BWJ/CDLD		203380OL	Drive Shaft		36		59.5	40	487
2.0 (195 kw)	2009.09-2013.08	6MT	F	L	Hatchback FWD CDLA		203295OL	Drive Shaft		36		59.5	40.5	486
	2009.09-2013.08	Semi-AT	F	L	Hatchback FWD CDLA		203380OL	Drive Shaft		36		59.5	40	487
Leon SC														
1.2 (63 kw)	2013.01-2018.08	5MT	F	L	Hatchback FWD CJZB/CYVA	For PR code:1PA/1PE/2H4	203373OL	Drive Shaft		36		59.5	40	517
	2013.01-2018.08	5MT	F	R	Hatchback FWD CJZB/CYVA		261096OL	Drive Shaft		36		59.5	40	800
	2013.01-2018.08	MT	F	L	Hatchback FWD CJZB/CYVA		203294OL	Drive Shaft		36		59.5	40	517
	2013.01-2018.08	MT	F	R	Hatchback FWD CJZB/CYVA		261042OL	Drive Shaft		36		59.5	40	814





  YEAR	TRANSM.	F/R	L/R	BODY STYLE & DRIVE TYPE & ENGINE	REMARKS	GSP Ref.	 PRODUCT	 ABS	Technical Specifications				
									A	B	C	H	L
SEAT Leon SC													
1.2 (63 kw)	2013.01-2018.08	MT	F	R	Hatchback FWD CJZB/CYVA	2613070L	Drive Shaft		36	59.5	40	820	
1.2 (77 kw)	2013.02-2014.04	5MT/6MT	F	L	Hatchback FWD CJZA	2033730L	Drive Shaft		36	59.5	40	517	
	2013.02-2014.04	5MT/6MT	F	R	Hatchback FWD CJZA	2613070L	Drive Shaft		36	59.5	40	820	
	2013.02-2014.04	7DCT	F	L	Hatchback FWD CJZA	2612820L	Drive Shaft		36	59.5	40	523	
	2013.02-2014.04	7DCT	F	R	Hatchback FWD CJZA	2610960L	Drive Shaft		36	59.5	40	800	
	2013.02-2014.04	MT	F	L	Hatchback FWD CJZA	2032940L	Drive Shaft		36	59.5	40	517	
	2013.02-2014.04	MT	F	R	Hatchback FWD CJZA	2610420L	Drive Shaft		36	59.5	40	814	
1.2 (81 kw)	2014.05-2018.08	5MT/6MT	F	L	Hatchback FWD CYVB	2033730L	Drive Shaft		36	59.5	40	517	
	2014.05-2018.08	5MT/6MT	F	R	Hatchback FWD CYVB	2613070L	Drive Shaft		36	59.5	40	820	
	2014.05-2018.08	7DCT	F	L	Hatchback FWD CYVB	2612820L	Drive Shaft		36	59.5	40	523	
1.4 (90 kw)	2013.02-2015.06	6MT	F	L	Hatchback FWD CMBA/CXSA	2612820L	Drive Shaft		36	59.5	40	523	
	2013.02-2015.06	6MT	F	R	Hatchback FWD CMBA/CXSA	2613070L	Drive Shaft		36	59.5	40	820	
	2014.05-2018.08	6MT	F	L	Hatchback FWD CZCA	2612820L	Drive Shaft		36	59.5	40	523	
1.4 (92 kw)	2014.05-2018.08	6MT	F	L	Hatchback FWD CZCA	2612820L	Drive Shaft		36	59.5	40	523	
	2014.05-2018.08	6MT	F	R	Hatchback FWD CZCA	2613070L	Drive Shaft		36	59.5	40	820	
1.4 (103 kw)	2013.02-2016.11	6MT	F	L	Hatchback FWD CHPA/CPTA	2612820L	Drive Shaft		36	59.5	40	523	
	2013.02-2016.11	6MT	F	R	Hatchback FWD CHPA/CPTA	2612830L	Drive Shaft		36	59.5	40	815	
	2013.02-2016.11	6MT	F	R	Hatchback FWD CHPA/CPTA	2613070L	Drive Shaft		36	59.5	40	820	
	2013.02-2016.11	7DCT	F	L	Hatchback FWD CHPA/CPTA	2611000L	Drive Shaft		36	59.5	40.5	514	
	2013.02-2016.11	7DCT	F	R	Hatchback FWD CHPA/CPTA	2033130L	Drive Shaft		36	59.5	40.5	794	
	2013.02-2016.11	MT	F	L	Hatchback FWD CHPA/CPTA	2032940L	Drive Shaft		36	59.5	40	517	
1.4 (110 kw)	2014.05-2018.08	6MT	F	L	Hatchback FWD CZEA	2612820L	Drive Shaft		36	59.5	40	523	
	2014.05-2018.08	6MT	F	R	Hatchback FWD CZEA	2612830L	Drive Shaft		36	59.5	40	815	
	2014.05-2018.08	7DCT	F	L	Hatchback FWD CZEA	2611000L	Drive Shaft		36	59.5	40.5	514	
	2014.05-2018.08	7DCT	F	R	Hatchback FWD CZEA	2033130L	Drive Shaft		36	59.5	40.5	794	
1.6 (66 kw)	2013.02-2018.08	5MT	F	L	Hatchback FWD CLHB/CXXA/DDYB	2032940L	Drive Shaft		36	59.5	40	517	
	2013.02-2018.08	5MT	F	R	Hatchback FWD CLHB/CXXA/DDYB	2610420L	Drive Shaft		36	59.5	40	814	
	2013.02-2018.08	5MT	F	R	Hatchback FWD CLHB/CXXA/DDYB	2612830L	Drive Shaft		36	59.5	40	815	
1.6 (77 kw)	2013.02-2018.08	5MT	F	R	Hatchback FWD CLHA	2610420L	Drive Shaft		36	59.5	40	814	
	2013.02-2018.08	5MT	F	R	Hatchback FWD CLHA	2612830L	Drive Shaft		36	59.5	40	815	
	2013.02-2018.08	5MT/7DCT	F	L	Hatchback FWD CLHA	2612820L	Drive Shaft		36	59.5	40	523	
	2013.02-2018.08	7DCT	F	R	Hatchback FWD CLHA	2610960L	Drive Shaft		36	59.5	40	800	
	2013.02-2018.08	MT	F	L	Hatchback FWD CLHA	2032940L	Drive Shaft		36	59.5	40	517	
1.6 (81 kw)	2013.09-2016.11	5MT/6MT	F	R	Hatchback FWD CRKB/CXXB	2612830L	Drive Shaft		36	59.5	40	815	
	2013.09-2016.11	5MT/6MT/7DCT	F	L	Hatchback FWD CRKB/CXXB	2612820L	Drive Shaft		36	59.5	40	523	
	2013.09-2016.11	7DCT	F	R	Hatchback FWD CRKB/CXXB	2610960L	Drive Shaft		36	59.5	40	800	
	2013.09-2016.11		F	L	Hatchback FWD CRKB/CXXB	2032940L	Drive Shaft		36	59.5	40	517	
1.6 (85 kw)	2016.11-2018.08	5MT	F	R	Hatchback FWD DDYA	2610420L	Drive Shaft		36	59.5	40	814	
	2016.11-2018.08	5MT	F	R	Hatchback FWD DDYA	2612830L	Drive Shaft		36	59.5	40	815	
	2016.11-2018.08	5MT/7DCT	F	L	Hatchback FWD DDYA	2612820L	Drive Shaft		36	59.5	40	523	
	2016.11-2018.08	7DCT	F	R	Hatchback FWD DDYA	2610960L	Drive Shaft		36	59.5	40	800	
1.8 (132 kw)	2013.02-2018.08	6MT	F	L	Hatchback FWD CJSA	2611000L	Drive Shaft		36	59.5	40.5	514	
2.0 (105 kw)	2013.05-2018.08	6MT	F	R	Hatchback FWD CRVC	2033130L	Drive Shaft		36	59.5	40.5	794	
	2013.05-2018.08	AT	F	L	Hatchback FWD CRVC	2612850L	Drive Shaft		36	59.5	40	472	
	2013.05-2018.08	AT	F	R	Hatchback FWD CRVC	2033540L	Drive Shaft		36	59.5	40	760	
2.0 (110 kw)	2013.02-2018.08	6DCT	F	L	Hatchback FWD CKFC/CRMB	2612850L	Drive Shaft		36	59.5	40	472	
	2013.02-2018.08	6DCT	F	R	Hatchback FWD CKFC/CRMB	2033540L	Drive Shaft		36	59.5	40	760	
	2013.02-2018.08	6MT	F	R	Hatchback FWD CKFC/CRMB	2033130L	Drive Shaft		36	59.5	40.5	794	
	2013.02-2018.08	AT	F	R	Hatchback FWD CKFC/CRMB	2540110L	Drive Shaft		36	59.5	40.5	760	
2.0 (135 kw)	2013.03-2018.08	6DCT	F	L	Hatchback FWD CUNA/CUPA	2612850L	Drive Shaft		36	59.5	40	472	
	2013.03-2018.08	6DCT	F	R	Hatchback FWD CUNA/CUPA	2033540L	Drive Shaft		36	59.5	40	760	
Leon Sportstourer													
1.5 (110 kw)	2020.03-	7AT	F	L	Estate FWD DFYA	2611000L	Drive Shaft		36	59.5	40.5	514	
Leon ST													
1.2 (63 kw)	2013.01-2018.08	5MT	F	R	Combi Van FWD CJZB/CYVA	2610960L	Drive Shaft		36	59.5	40	800	
	2013.01-2018.08	MT	F	L	Combi Van FWD CJZB/CYVA	2032940L	Drive Shaft		36	59.5	40	517	
	2013.01-2018.08	MT	F	R	Combi Van FWD CJZB/CYVA	2610420L	Drive Shaft		36	59.5	40	814	
	2013.01-2018.08	5MT	F	R	Estate FWD CJZB/CYVA	2610960L	Drive Shaft		36	59.5	40	800	
	2013.01-2018.08	MT	F	L	Estate FWD CJZB/CYVA	Date From:2014.01	2032940L	Drive Shaft		36	59.5	40	517
	2013.01-2018.08	MT	F	L	Estate FWD CJZB/CYVA	Date From:2014.01	2033730L	Drive Shaft		36	59.5	40	517
	2013.01-2018.08	MT	F	R	Estate FWD CJZB/CYVA	Date From:2014.01	2610420L	Drive Shaft		36	59.5	40	814
1.2 (77 kw)	2013.08-2020.08	5MT/6MT	F	L	Estate FWD CJZA	2033730L	Drive Shaft		36	59.5	40	517	
	2013.08-2020.08	5MT/6MT	F	R	Estate FWD CJZA	2613070L	Drive Shaft		36	59.5	40	820	
	2013.08-2020.08	7DCT	F	L	Estate FWD CJZA	2612820L	Drive Shaft		36	59.5	40	523	
	2013.08-2020.08	7DCT	F	R	Estate FWD CJZA	2610960L	Drive Shaft		36	59.5	40	800	



 SEAT Leon ST	 YEAR	TRNSM.	F/R	L/R	BODY STYLE & DRIVE TYPE & ENGINE	REMARKS	GSP Ref.	 PRODUCT	 ABS	Technical Specifications				
	A	B	C	H	L									
1.2 (77 kw)	2013.08-2020.08	MT	F	L	Estate FWD CJZA	Date From:2014.01	2032940L	Drive Shaft		36		59.5	40	517
	2013.08-2020.08	MT	F	R	Estate FWD CJZA	Date From:2014.01	2610420L	Drive Shaft		36		59.5	40	814
1.2 (81 kw)	2014.05-2018.08	6MT	F	L	Combi Van FWD CYVB		2033730L	Drive Shaft		36		59.5	40	517
	2014.05-2018.08	6MT	F	R	Combi Van FWD CYVB		2613070L	Drive Shaft		36		59.5	40	820
	2014.05-2018.08	7DCT	F	L	Combi Van FWD CYVB		2612820L	Drive Shaft		36		59.5	40	523
	2014.05-2018.08	7DCT	F	R	Combi Van FWD CYVB		2610960L	Drive Shaft		36		59.5	40	800
	2014.05-2020.08	5MT/6MT	F	L	Estate FWD CYVB		2033730L	Drive Shaft		36		59.5	40	517
	2014.05-2020.08	5MT/6MT	F	R	Estate FWD CYVB		2613070L	Drive Shaft		36		59.5	40	820
	2014.05-2020.08	7DCT	F	L	Estate FWD CYVB		2612820L	Drive Shaft		36		59.5	40	523
	2014.05-2020.08	7DCT	F	R	Estate FWD CYVB		2610960L	Drive Shaft		36		59.5	40	800
	2014.05-2020.08	AT	F	L	Estate FWD CYVB		2032940L	Drive Shaft		36		59.5	40	517
1.4 (81 kw)	2014.08-2018.08	6MT	F	R	Estate FWD CPWA		2613070L	Drive Shaft		36		59.5	40	820
	2014.08-2018.08	6MT/7DCT	F	L	Estate FWD CPWA		2612820L	Drive Shaft		36		59.5	40	523
	2014.08-2018.08	7DCT	F	R	Estate FWD CPWA		2610960L	Drive Shaft		36		59.5	40	800
1.4 (90 kw)	2012.09-2015.06	6MT	F	L	Estate FWD CMBA/CXSA	For Engine Code:CHPA;Trans. code:MQ200	2612820L	Drive Shaft		36		59.5	40	523
	2012.09-2015.06	6MT	F	R	Estate FWD CMBA/CXSA	For Engine Code:CHPA;Trans. code:MQ200	2613070L	Drive Shaft		36		59.5	40	820
1.4 (92 kw)	2014.05-2018.08	6MT	F	L	Estate FWD CZCA		2612820L	Drive Shaft		36		59.5	40	523
	2014.05-2018.08	6MT	F	R	Estate FWD CZCA		2613070L	Drive Shaft		36		59.5	40	820
1.4 (103 kw)	2013.10-2020.08	6MT	F	L	Estate FWD CHPA/CPTA		2612830L	Drive Shaft		36		59.5	40	523
	2013.10-2020.08	6MT	F	R	Estate FWD CHPA/CPTA	For Engine Code:CHPA;Trans. code:MQ250	2612830L	Drive Shaft		36		59.5	40	815
	2013.10-2020.08	6MT	F	R	Estate FWD CHPA/CPTA	For Engine Code:CHPA;Trans. code:MQ200	2613070L	Drive Shaft		36		59.5	40	820
	2013.10-2020.08	7DCT	F	L	Estate FWD CHPA/CPTA		2611000L	Drive Shaft		36		59.5	40.5	514
	2013.10-2020.08	7DCT	F	R	Estate FWD CHPA/CPTA		2033130L	Drive Shaft		36		59.5	40.5	794
1.4 (110 kw)	2013.10-2020.08	MT	F	L	Estate FWD CHPA/CPTA		2032940L	Drive Shaft		36		59.5	40	517
	2014.05-2020.08	6MT	F	L	Combi Van FWD CZDA/CZEA		2612820L	Drive Shaft		36		59.5	40	523
	2014.05-2020.08	6MT	F	R	Combi Van FWD CZDA/CZEA		2612830L	Drive Shaft		36		59.5	40	815
	2014.05-2020.08	7DCT	F	L	Combi Van FWD CZDA/CZEA		2611000L	Drive Shaft		36		59.5	40.5	514
	2014.05-2020.08	7DCT	F	R	Combi Van FWD CZDA/CZEA		2033130L	Drive Shaft		36		59.5	40.5	794
	2014.05-2020.08	6MT	F	L	Estate FWD CZEA		2612820L	Drive Shaft		36		59.5	40	523
	2014.05-2020.08	6MT	F	R	Estate FWD CZEA		2612830L	Drive Shaft		36		59.5	40	815
	2014.05-2020.08	7DCT	F	L	Estate FWD CZEA		2611000L	Drive Shaft		36		59.5	40.5	514
	2014.05-2020.08	7DCT	F	R	Estate FWD CZEA		2033130L	Drive Shaft		36		59.5	40.5	794
1.5 (96 kw)	2018.10-2020.08	7DCT	F	L	Estate FWD DHFA		2611000L	Drive Shaft		36		59.5	40.5	514
1.5 (110 kw)	2018.07-2020.08	6MT	F	L	Estate FWD DADA/DPCA		2612820L	Drive Shaft		36		59.5	40	523
	2018.07-2020.08	7DCT	F	L	Estate FWD DADA/DPCA		2611000L	Drive Shaft		36		59.5	40.5	514
1.6 (66 kw)	2013.11-2020.08	5MT	F	L	Estate FWD CLHB/CXXA/DDYB		2032940L	Drive Shaft		36		59.5	40	517
	2013.11-2020.08	5MT	F	R	Estate FWD CLHB/CXXA/DDYB		2610420L	Drive Shaft		36		59.5	40	814
	2013.11-2020.08	5MT	F	R	Estate FWD CLHB/CXXA/DDYB		2612830L	Drive Shaft		36		59.5	40	815
1.6 (77 kw)	2013.10-2020.08	5MT	F	L	Estate FWD CLHA		2612820L	Drive Shaft		36		59.5	40	523
	2013.10-2020.08	5MT	F	R	Estate FWD CLHA		2610420L	Drive Shaft		36		59.5	40	814
	2013.10-2020.08	5MT	F	R	Estate FWD CLHA		2612830L	Drive Shaft		36		59.5	40	815
	2013.10-2020.08	7DCT	F	R	Estate FWD CLHA		2610960L	Drive Shaft		36		59.5	40	800
	2013.10-2020.08	MT	F	L	Estate FWD CLHA		2032940L	Drive Shaft		36		59.5	40	517
1.6 (81 kw)	2013.09-2020.08	6MT	F	R	Combi Van FWD CRKB/CXXB/DBKA		2612830L	Drive Shaft		36		59.5	40	815
	2013.09-2020.08	6MT/7DCT	F	L	Combi Van FWD CRKB/CXXB/DBKA		2612820L	Drive Shaft		36		59.5	40	523
	2013.09-2020.08	7DCT	F	R	Combi Van FWD CRKB/CXXB/DBKA		2610960L	Drive Shaft		36		59.5	40	800
	2013.09-2020.08	5MT/6MT	F	R	Estate FWD CRKB/CXXB/DBKA		2612830L	Drive Shaft		36		59.5	40	815
	2013.09-2020.08	5MT/6MT/7DCT	F	L	Estate FWD CRKB/CXXB/DBKA		2612820L	Drive Shaft		36		59.5	40	523
	2013.09-2020.08	7DCT	F	R	Estate FWD CRKB/CXXB/DBKA		2610960L	Drive Shaft		36		59.5	40	800
1.6 (85 kw)	2013.09-2020.08		F	L	Estate FWD CRKB/CXXB/DBKA		2032940L	Drive Shaft		36		59.5	40	517
	2016.11-2020.08	5MT	F	R	Combi Van FWD DDYA		2610420L	Drive Shaft		36		59.5	40	814
	2016.11-2020.08	5MT	F	R	Combi Van FWD DDYA		2612830L	Drive Shaft		36		59.5	40	815
	2016.11-2020.08	5MT/7DCT	F	L	Combi Van FWD DDYA		2612820L	Drive Shaft		36		59.5	40	523
	2016.11-2020.08	7DCT	F	R	Combi Van FWD DDYA		2610960L	Drive Shaft		36		59.5	40	800
	2016.11-2020.08	5MT	F	R	Estate FWD DDYA/DGTE		2610420L	Drive Shaft		36		59.5	40	814
	2016.11-2020.08	5MT	F	R	Estate FWD DDYA/DGTE		2612830L	Drive Shaft		36		59.5	40	815
	2016.11-2020.08	5MT/7DCT	F	L	Estate FWD DDYA/DGTE		2612820L	Drive Shaft		36		59.5	40	523
1.8 (132 kw)	2013.10-2018.08	6MT	F	L	Combi Van FWD CJSA		2611000L	Drive Shaft		36		59.5	40.5	514
	2013.10-2018.08	6MT	F	L	Estate FWD CJSA		2611000L	Drive Shaft		36		59.5	40.5	514
	2013.02-2016.12	5MT	F	L	Estate FWD CRLD/CRVA		2612820L	Drive Shaft		36		59.5	40	523
2.0 (81 kw)	2013.02-2016.12	5MT	F	R	Estate FWD CRLD/CRVA		2612830L	Drive Shaft		36		59.5	40	815
	2013.02-2016.12		F	L	Estate FWD CRLD/CRVA		2032940L	Drive Shaft		36		59.5	40	517
2.0 (105 kw)	2013.04-2018.08	6MT	F	R	Estate FWD CRVC		2033130L	Drive Shaft		36		59.5	40.5	794
	2013.04-2018.08	AT	F	L	Estate FWD CRVC		2612850L	Drive Shaft		36		59.5	40	472





  YEAR	TRANSM.	F/R	L/R	BODY STYLE & DRIVE TYPE & ENGINE	REMARKS	GSP Ref.	 PRODUCT	 ABS	Technical Specifications					
									A	B	C	H	L	
SEAT														
Leon ST														
2.0 (105 kw)	2013.04-2018.08	AT	F	R	Estate FWD CRVC		2033540L	Drive Shaft		36		59.5	40	760
2.0 (110 kw)	2012.10-2020.08	6DCT	F	L	Estate FWD CKFC/CRBC/CRLB/CRMB/OFFA/DFGA		2612850L	Drive Shaft		36		59.5	40	472
	2012.10-2020.08	6DCT	F	R	Estate FWD CKFC/CRBC/CRLB/CRMB/OFFA/DFGA		2033540L	Drive Shaft		36		59.5	40	760
	2012.10-2020.08	6MT	F	L	Estate FWD CKFC/CRBC/CRLB/CRMB/OFFA/DFGA	For taxis	2032950L	Drive Shaft		36		59.5	40.5	486
	2012.10-2020.08	6MT	F	R	Estate FWD CKFC/CRBC/CRLB/CRMB/OFFA/DFGA		2033130L	Drive Shaft		36		59.5	40.5	794
	2012.10-2020.08	7DCT	F	L	Estate FWD CKFC/CRBC/CRLB/CRMB/OFFA/DFGA		2012650L	Drive Shaft		36	37	59.5	40	558
	2012.10-2020.08	AT	F	R	Estate FWD CKFC/CRBC/CRLB/CRMB/OFFA/DFGA		2540110L	Drive Shaft		36		59.5	40.5	760
	2013.04-2020.08	6DCT	F	L	Combi Van FWD CKFC/CRBC/CRLB/CRMB		2612850L	Drive Shaft		36		59.5	40	472
	2013.04-2020.08	6DCT	F	R	Combi Van FWD CKFC/CRBC/CRLB/CRMB		2033540L	Drive Shaft		36		59.5	40	760
	2013.04-2020.08	6MT	F	R	Combi Van FWD CKFC/CRBC/CRLB/CRMB		2033130L	Drive Shaft		36		59.5	40.5	794
2.0 (135 kw)	2013.08-2018.08	6DCT	F	L	Combi Van FWD CUNA/CUPA		2612850L	Drive Shaft		36		59.5	40	472
	2013.08-2018.08	6DCT	F	R	Combi Van FWD CUNA/CUPA		2033540L	Drive Shaft		36		59.5	40	760
	2013.08-2020.08	6DCT	F	L	Estate FWD CUNA/CUPA/DJGA		2612850L	Drive Shaft		36		59.5	40	472
	2013.08-2020.08	6DCT	F	R	Estate FWD CUNA/CUPA/DJGA		2033540L	Drive Shaft		36		59.5	40	760
	2013.08-2020.08	6MT	F	L	Estate FWD CUNA/CUPA/DJGA		2032950L	Drive Shaft		36		59.5	40.5	486
	2013.08-2020.08	6MT	F	R	Estate FWD CUNA/CUPA/DJGA		2033130L	Drive Shaft		36		59.5	40.5	794
	2013.08-2020.08	7DCT	F	L	Estate FWD CUNA/CUPA/DJGA		2012650L	Drive Shaft		36	37	59.5	40	558
	2014.10-2018.08	6AT	F	L	Combi Van 4WD CUNA		2612850L	Drive Shaft		36		59.5	40	472
	2014.10-2018.08	6AT	F	R	Estate 4WD CUNA/DJGA		2612850L	Drive Shaft		36		59.5	40	472
Tarraco														
1.5 (110 kw)	2018.09-	6MT	F	L	SUV FWD DADA/DPCA/DXDB		2018960L	Drive Shaft		36		59.5	40	500
2.0 (110 kw)	2018.09-	7AT	F	L	SUV 4WD DFGA		2023510L	Drive Shaft		36	37	59.5	40	570
	2018.09-	6MT	F	L	SUV FWD DFGA/DTSA/DTSB		2611000L	Drive Shaft		36		59.5	40.5	514
	2018.09-	6MT	F	R	SUV FWD DFGA/DTSA/DTSB		2613410L	Drive Shaft		36		59.5	40.5	806
	2018.09-	7DCT	F	R	SUV FWD DFGA/DTSA/DTSB		2036130L	Drive Shaft		36	37	59.5	40	921
2.0 (140 kw)	2018.09-	7AT	F	L	SUV 4WD DFHA		2023510L	Drive Shaft		36	37	59.5	40	570
	2018.11-	7AT	F	R	SUV 4WD DKZA		2018890L	Drive Shaft		36		59.5	40	614
2.0 (180 kw)	2021.01-	7AT	F	L	SUV 4WD DNPA		2023510L	Drive Shaft		36	37	59.5	40	570
Toledo														
1.4 (92 kw)	2007.11-2009.05	6MT	F	L	MPV FWD CAXC		2612010L	Drive Shaft		36		59.5	40	536
	2007.11-2009.05	6MT	F	R	MPV FWD CAXC		2610960L	Drive Shaft		36		59.5	40	800
1.6 (75 kw)	2004.10-2009.05	5MT	F	R	MPV FWD BGU/BSE/BSF/CCSA		2610960L	Drive Shaft		36		59.5	40	800
1.8 (118 kw)	2007.01-2009.05	7AT/6MT	F	L	MPV FWD BYT/BZB/CDAA		2611000L	Drive Shaft		36		59.5	40.5	514
	2007.01-2009.05	7AT/6MT	F	R	MPV FWD BYT/BZB/CDAA		2613410L	Drive Shaft		36		59.5	40.5	806
1.9 (77 kw)	2004.09-2009.05	6AT/5MT	F	L	MPV FWD BJB/BKC/BLS/BXE		2032940L	Drive Shaft		36		59.5	40	517
	2004.09-2009.05	6AT/5MT	F	R	MPV FWD BJB/BKC/BLS/BXE		2610420L	Drive Shaft		36		59.5	40	814
2.0 (100 kw)	2004.09-2009.05	AT	F	L	MPV FWD AZV	Date From:2008.03	2033810L	Drive Shaft		36		59.5	40	485
	2004.09-2009.05	AT	F	L	MPV FWD AZV	Date To:2008.02	2540130L	Drive Shaft		36		59.5	40.5	482
	2004.09-2009.05	AT	F	R	MPV FWD AZV		2540110L	Drive Shaft		36		59.5	40.5	760
	2004.09-2009.05	MT	F	L	MPV FWD AZV		2032950L	Drive Shaft		36		59.5	40.5	486
	2004.09-2009.05	MT	F	R	MPV FWD AZV		2033130L	Drive Shaft		36		59.5	40.5	794
	2004.09-2009.05	MT	F	R	MPV FWD AZV		2033800L	Drive Shaft		36		59.5	40	487
2.0 (103 kw)	2004.04-2009.05	AT	F	L	MPV FWD BKD	<small>See Note 2008.04 Date To:2008.04;Chassis no. from:SP9052001;For taxis</small>	2033810L	Drive Shaft		36		59.5	40	485
	2004.04-2009.05	AT	F	L	MPV FWD BKD	Date From:2008.04;Chassis no. from:SP9052001;For taxis	2033810L	Drive Shaft		36		59.5	40	485
	2004.04-2009.05	AT	F	L	MPV FWD BKD		2540130L	Drive Shaft		36		59.5	40.5	482
	2004.04-2009.05	AT	F	R	MPV FWD BKD		2540110L	Drive Shaft		36		59.5	40.5	760
	2004.04-2009.05	MT	F	L	MPV FWD BKD		2032950L	Drive Shaft		36		59.5	40.5	486
	2004.04-2009.05	MT	F	R	MPV FWD BKD		2033130L	Drive Shaft		36		59.5	40.5	794
	2004.04-2009.05	MT	F	R	MPV FWD BKD		2033800L	Drive Shaft		36		59.5	40	487
	2005.11-2009.05	AT	F	L	MPV FWD BMM	Date From:2008.03;For taxis	2033810L	Drive Shaft		36		59.5	40	485
	2005.11-2009.05	AT	F	L	MPV FWD BMM	Date To:2008.02;For taxis	2540130L	Drive Shaft		36		59.5	40.5	482
	2005.11-2009.05	AT	F	R	MPV FWD BMM		2540110L	Drive Shaft		36		59.5	40.5	760
	2005.11-2009.05	MT	F	L	MPV FWD BMM		2032950L	Drive Shaft		36		59.5	40.5	486
	2005.11-2009.05	MT	F	R	MPV FWD BMM		2033800L	Drive Shaft		36		59.5	40	487
	2005.11-2009.05	MT	F	R	MPV FWD BMM		2033130L	Drive Shaft		36		59.5	40.5	794
2.0 (110 kw)	2004.09-2009.03	AT	F	R	MPV FWD BLR/BLY/BVY/BVZ		2610940L	Drive Shaft		36	26	59.5	40	884
	2004.09-2009.03	MT	F	L	MPV FWD BLR/BLY/BVY/BVZ		2032940L	Drive Shaft		36		59.5	40	517
	2004.09-2009.03	MT	F	R	MPV FWD BLR/BLY/BVY/BVZ		2610420L	Drive Shaft		36		59.5	40	814
2.0 (125 kw)	2006.01-2009.05	MT	F	L	MPV FWD BMN/CEGA		2032950L	Drive Shaft		36		59.5	40.5	486
	2006.01-2009.05	MT	F	L	MPV FWD BMN/CEGA		2033800L	Drive Shaft		36		59.5	40	487
	2006.01-2009.05	MT	F	R	MPV FWD BMN/CEGA		2033130L	Drive Shaft		36		59.5	40.5	794
2.0 (147 kw)	2005.11-2009.05	6AT/6MT	F	L	MPV FWD BWA		2032950L	Drive Shaft		36		59.5	40.5	486



	 YEAR	TRANSM.	F/R	L/R	BODY STYLE & DRIVE TYPE & ENGINE	REMARKS	GSP Ref.	 PRODUCT	 ABS	Technical Specifications				
										A	B	C	H	L
SKODA														
Karoq														
1.5 (110 kw)	2017.07-	6MT	F	L	SUV 4WD DADA/DPCA		2018960L	Drive Shaft		36		59.5	40	500
	2017.07-	6MT	F	L	SUV FWD DADA/DPCA	For PR code:0ED	2018960L	Drive Shaft		36		59.5	40	500
	2017.07-	6MT	F	R	SUV FWD DADA/DPCA	For PR code:0ED	2033130L	Drive Shaft		36		59.5	40.5	794
1.6 (85 kw)	2017.07-	6MT/7DCT	F	L	SUV FWD DDYA/DGTE		2612010L	Drive Shaft		36		59.5	40	536
	2017.07-	7DCT	F	R	SUV FWD DDYA/DGTE		2612830L	Drive Shaft		36		59.5	40	815
2.0 (110 kw)	2017.07-	6MT	F	L	SUV 4WD DFFA		2018960L	Drive Shaft		36		59.5	40	500
	2017.07-	6MT	F	R	SUV 4WD DFFA		2018890L	Drive Shaft		36		59.5	40	614
	2017.07-	6MT/7DCT	F	L	SUV 4WD DFFA	Model:Karoq Scout	2023510L	Drive Shaft		36	37	59.5	40	570
	2017.07-	7DCT	F	L	SUV 4WD DFFA		2023510L	Drive Shaft		36	37	59.5	40	570
	2017.07-	6MT	F	L	SUV FWD DFFA/DTTA/DTTC		2611000L	Drive Shaft		36		59.5	40.5	514
2.0 (140 kw)	2017.07-	6MT	F	R	SUV FWD DFFA/DTTA/DTTC		2613410L	Drive Shaft		36		59.5	40.5	806
2.0 (140 kw)	2017.07-	7DCT	F	L	SUV 4WD DFHA		2023510L	Drive Shaft		36	37	59.5	40	570
Karoq Scout														
2.0 (110 kw)	2018.07-	6MT	F	L	SUV 4WD DFFA	Model:Karoq	2018960L	Drive Shaft		36		59.5	40	500
	2018.07-	6MT	F	R	SUV 4WD DFFA	Model:Karoq	2018890L	Drive Shaft		36		59.5	40	614
	2018.07-	6MT/7DCT	F	L	SUV 4WD DFFA		2023510L	Drive Shaft		36	37	59.5	40	570
	2018.07-	7DCT	F	L	SUV 4WD DFFA	Model:Karoq	2023510L	Drive Shaft		36	37	59.5	40	570
2.0 (140 kw)	2018.07-	7DCT	F	L	SUV 4WD DFHA		2023510L	Drive Shaft		36	37	59.5	40	570
Kodiatq														
1.4 (92 kw)	2016.10-	6MT	F	L	SUV FWD CZCA/CZDB		2018960L	Drive Shaft		36		59.5	40	500
1.4 (110 kw)	2016.10-	6AT/6MT	F	L	SUV 4WD CZDA/CZEA		2018960L	Drive Shaft		36		59.5	40	500
	2016.10-	6AT	F	L	SUV FWD CZDA/CZEA		2018960L	Drive Shaft		36		59.5	40	500
1.5 (110 kw)	2018.07-	6MT	F	L	SUV FWD DADA/DPCA		2018960L	Drive Shaft		36		59.5	40	500
2.0 (85 kw)	2019.02-	6MT	F	L	SUV FWD DFGC		2611000L	Drive Shaft		36		59.5	40.5	514
	2019.02-	6MT	F	R	SUV FWD DFGC		2613410L	Drive Shaft		36		59.5	40.5	806
2.0 (110 kw)	2017.03-	6MT	F	L	SUV 4WD DBGC/DFGA/DTSB		2018960L	Drive Shaft		36		59.5	40	500
	2017.03-	6MT	F	R	SUV 4WD DBGC/DFGA/DTSB		2018890L	Drive Shaft		36		59.5	40	614
	2017.03-	7DCT	F	L	SUV 4WD DBGC/DFGA/DTSB		2023510L	Drive Shaft		36	37	59.5	40	570
	2017.03-	7AT	F	L	SUV FWD DBGC/DFGA/DTSB		2023510L	Drive Shaft		36	37	59.5	40	570
	2017.03-	7DCT	F	R	SUV FWD DBGC/DFGA/DTSB		2036130L	Drive Shaft		36	37	59.5	40	921
2.0 (132 kw)	2016.10-	7AT	F	L	SUV 4WD CZPA		2023510L	Drive Shaft		36	37	59.5	40	570
2.0 (140 kw)	2016.10-	7AT	F	L	SUV 4WD DFHA		2023510L	Drive Shaft		36	37	59.5	40	570
	2019.02-	7AT	F	L	SUV 4WD DKZA		2023510L	Drive Shaft		36	37	59.5	40	570
2.0 (176 kw)	2018.07-	7AT	F	L	SUV 4WD CUAA		2023510L	Drive Shaft		36	37	59.5	40	570
Kodiatq Scout														
1.4 (110 kw)	2017.05-	6AT/6MT	F	L	SUV 4WD CZDA/CZEA		2018960L	Drive Shaft		36		59.5	40	500
2.0 (110 kw)	2017.05-	6MT	F	L	SUV 4WD DBGC/DFGA		2018960L	Drive Shaft		36		59.5	40	500
	2017.05-	6MT	F	R	SUV 4WD DBGC/DFGA		2018890L	Drive Shaft		36		59.5	40	614
	2017.05-	7DCT	F	L	SUV 4WD DBGC/DFGA		2023510L	Drive Shaft		36	37	59.5	40	570
2.0 (132 kw)	2017.05-	7AT	F	L	SUV 4WD CZPA		2023510L	Drive Shaft		36	37	59.5	40	570
2.0 (140 kw)	2017.05-	7AT	F	L	SUV 4WD DFHA		2023510L	Drive Shaft		36	37	59.5	40	570
	2019.02-	7AT	F	L	SUV 4WD DKZA		2023510L	Drive Shaft		36	37	59.5	40	570
Octavia														
1.2 (63 kw)	2012.11-2017.02	5MT	F	R	Estate FWD CJZB/CYVA		2610960L	Drive Shaft		36		59.5	40	800
	2012.11-2017.02	MT	F	L	Estate FWD CJZB/CYVA	Date From:2013.01	2032940L	Drive Shaft		36		59.5	40	517
	2012.11-2017.02	MT	F	L	Estate FWD CJZB/CYVA		2033730L	Drive Shaft		36		59.5	40	517
	2012.11-2017.02	MT	F	R	Estate FWD CJZB/CYVA	Date From:2013.01	2610420L	Drive Shaft		36		59.5	40	814
	2012.11-2017.02	5MT	F	R	Hatchback FWD CJZB/CYVA		2610960L	Drive Shaft		36		59.5	40	800
1.2 (77 kw)	2010.02-2013.03	7AT/6MT	F	L	Estate FWD CBZB		2612010L	Drive Shaft		36		59.5	40	536
	2010.02-2013.03	7AT/6MT	F	R	Estate FWD CBZB		2610960L	Drive Shaft		36		59.5	40	800
	2010.02-2013.03		F	L	Estate FWD CBZB		2033730L	Drive Shaft		36		59.5	40	517
	2010.02-2013.03	7AT/6MT	F	L	Hatchback FWD CBZB		2612010L	Drive Shaft		36		59.5	40	536
	2010.02-2013.03	7AT/6MT	F	R	Hatchback FWD CBZB		2610960L	Drive Shaft		36		59.5	40	800
	2010.02-2013.03		F	L	Hatchback FWD CBZB		2033730L	Drive Shaft		36		59.5	40	517
	2012.11-2017.02	5MT/6MT	F	L	Estate FWD CJZA		2033730L	Drive Shaft		36		59.5	40	517
	2012.11-2017.02	5MT/6MT	F	R	Estate FWD CJZA		2613070L	Drive Shaft		36		59.5	40	820
	2012.11-2017.02	7DCT	F	L	Estate FWD CJZA		2612820L	Drive Shaft		36		59.5	40	523
	2012.11-2017.02	7DCT	F	R	Estate FWD CJZA		2610960L	Drive Shaft		36		59.5	40	800
	2012.11-2017.02	MT	F	L	Estate FWD CJZA		2032940L	Drive Shaft		36		59.5	40	517
	2012.11-2017.02	MT	F	R	Estate FWD CJZA		2610420L	Drive Shaft		36		59.5	40	814
	2012.11-2017.02	5MT/6MT	F	L	Hatchback FWD CJZA		2033730L	Drive Shaft		36		59.5	40	517
	2012.11-2017.02	5MT/6MT	F	R	Hatchback FWD CJZA		2613070L	Drive Shaft		36		59.5	40	820
	2012.11-2017.02	7DCT	F	L	Hatchback FWD CJZA		2612820L	Drive Shaft		36		59.5	40	523
	2012.11-2017.02	7DCT	F	R	Hatchback FWD CJZA		2610960L	Drive Shaft		36		59.5	40	800
	2012.11-2017.02	MT	F	L	Hatchback FWD CJZA		2032940L	Drive Shaft		36		59.5	40	517





  YEAR	TRANSM.	F/R	L/R	BODY STYLE & DRIVE TYPE & ENGINE	REMARKS	GSP Ref.	 PRODUCT	 ABS	Technical Specifications						
									A	B	C	H	L		
SKODA Octavia															
1.2 (77 kw)	2012.11-2017.02	MT	F	R	Hatchback FWD CJZA		2610420L	Drive Shaft		36		59.5	40	814	
1.2 (81 kw)	2015.05-2017.02	6MT	F	L	Estate FWD CYVB		2033730L	Drive Shaft		36		59.5	40	517	
	2015.05-2017.02	6MT	F	R	Estate FWD CYVB		2613070L	Drive Shaft		36		59.5	40	820	
	2015.05-2017.02	7DCT	F	L	Estate FWD CYVB		2612820L	Drive Shaft		36		59.5	40	523	
	2015.05-2017.02	7DCT	F	R	Estate FWD CYVB		2610960L	Drive Shaft		36		59.5	40	800	
	2015.05-2017.02	6MT	F	L	Hatchback FWD CYVB		2033730L	Drive Shaft		36		59.5	40	517	
	2015.05-2017.02	6MT	F	R	Hatchback FWD CYVB		2613070L	Drive Shaft		36		59.5	40	820	
	2015.05-2017.02	7DCT	F	L	Hatchback FWD CYVB		2612820L	Drive Shaft		36		59.5	40	523	
	2015.05-2017.02	7DCT	F	R	Hatchback FWD CYVB		2610960L	Drive Shaft		36		59.5	40	800	
1.4 (81 kw)	2012.11-2017.02	6MT	F	R	Estate FWD CPWA		2613070L	Drive Shaft		36		59.5	40	820	
	2012.11-2017.02	6MT/7DCT	F	L	Estate FWD CPWA		2612820L	Drive Shaft		36		59.5	40	523	
	2012.11-2017.02	7DCT	F	R	Estate FWD CPWA		2610960L	Drive Shaft		36		59.5	40	800	
	2012.11-2017.02	MT/7AT	F	L	Estate FWD CPWA		2032940L	Drive Shaft		36		59.5	40	517	
	2012.11-2017.02	6MT	F	R	Hatchback FWD CPWA		2613070L	Drive Shaft		36		59.5	40	820	
	2012.11-2017.02	6MT/7DCT	F	L	Hatchback FWD CPWA		2612820L	Drive Shaft		36		59.5	40	523	
	2012.11-2017.02	7DCT	F	R	Hatchback FWD CPWA		2610960L	Drive Shaft		36		59.5	40	800	
	2012.11-2017.02	MT/7AT	F	L	Hatchback FWD CPWA		2032940L	Drive Shaft		36		59.5	40	517	
1.4 (90 kw)	2008.11-2013.03	AT	F	L	Estate FWD CAXA		2612810L	Drive Shaft		36		59.5	40.5	525	
	2008.11-2013.03	AT	F	R	Estate FWD CAXA		2016530L	Drive Shaft		36		59.5	40.5	785	
	2008.11-2013.03	MT	F	L	Estate FWD CAXA		2612010L	Drive Shaft		36		59.5	40	536	
	2008.11-2013.03	MT	F	R	Estate FWD CAXA		2610960L	Drive Shaft		36		59.5	40	800	
	2008.11-2013.03	AT	F	L	Hatchback FWD CAXA		2032940L	Drive Shaft		36		59.5	40	517	
	2008.11-2013.03	AT	F	R	Hatchback FWD CAXA		2612810L	Drive Shaft		36		59.5	40.5	525	
	2008.11-2013.03	AT	F	L	Hatchback FWD CAXA		2016530L	Drive Shaft		36		59.5	40.5	785	
	2008.11-2013.03	MT	F	L	Hatchback FWD CAXA		2612010L	Drive Shaft		36		59.5	40	536	
	2008.11-2013.03	MT	F	R	Hatchback FWD CAXA		2610960L	Drive Shaft		36		59.5	40	800	
	1.4 (103 kw)	2012.11-2017.02	6AT	F	L	Estate FWD CHPA		2032940L	Drive Shaft		36		59.5	40	517
2012.11-2017.02		6AT	F	R	Estate FWD CHPA		2610960L	Drive Shaft		36		59.5	40	800	
2012.11-2017.02		6MT	F	L	Estate FWD CHPA		2612820L	Drive Shaft		36		59.5	40	523	
2012.11-2017.02		6MT	F	R	Estate FWD CHPA		2612830L	Drive Shaft		36		59.5	40	815	
2012.11-2017.02		7DCT	F	L	Estate FWD CHPA		2611000L	Drive Shaft		36		59.5	40.5	514	
2012.11-2017.02		7DCT	F	R	Estate FWD CHPA		2033130L	Drive Shaft		36		59.5	40.5	794	
2012.11-2017.02		6AT	F	L	Hatchback FWD CHPA		2032940L	Drive Shaft		36		59.5	40	517	
2012.11-2017.02		6AT	F	R	Hatchback FWD CHPA		2610960L	Drive Shaft		36		59.5	40	800	
2012.11-2017.02		6MT	F	L	Hatchback FWD CHPA		2612820L	Drive Shaft		36		59.5	40	523	
2012.11-2017.02		6MT	F	R	Hatchback FWD CHPA		2612830L	Drive Shaft		36		59.5	40	815	
2012.11-2017.02		7DCT	F	L	Hatchback FWD CHPA		2611000L	Drive Shaft		36		59.5	40.5	514	
2012.11-2017.02		7DCT	F	R	Hatchback FWD CHPA		2033130L	Drive Shaft		36		59.5	40.5	794	
1.4 (110 kw)		2014.08-2020.10	6MT	F	L	Estate FWD CHPB/CZDA	Inner teeth of wheel side:33	2612820L	Drive Shaft		36		59.5	40	523
		2014.08-2020.10	6MT	F	R	Estate FWD CHPB/CZDA		2612830L	Drive Shaft		36		59.5	40	815
	2014.08-2020.10	7DCT	F	L	Estate FWD CHPB/CZDA		2611000L	Drive Shaft		36		59.5	40.5	514	
	2014.08-2020.10	7DCT	F	R	Estate FWD CHPB/CZDA		2033130L	Drive Shaft		36		59.5	40.5	794	
	2014.08-2020.10	6AT	F	R	Hatchback FWD CHPB/CZDA		2610960L	Drive Shaft		36		59.5	40	800	
	2014.08-2020.10	6MT	F	L	Hatchback FWD CHPB/CZDA	Inner teeth of wheel side:33	2612820L	Drive Shaft		36		59.5	40	523	
	2014.08-2020.10	6MT	F	R	Hatchback FWD CHPB/CZDA		2612830L	Drive Shaft		36		59.5	40	815	
	2014.08-2020.10	7DCT	F	L	Hatchback FWD CHPB/CZDA		2611000L	Drive Shaft		36		59.5	40.5	514	
	2014.08-2020.10	7DCT	F	R	Hatchback FWD CHPB/CZDA		2033130L	Drive Shaft		36		59.5	40.5	794	
	2014.08-2020.10	MT/6AT	F	L	Hatchback FWD CHPB/CZDA	Inner teeth of wheel side:30	2032940L	Drive Shaft		36		59.5	40	517	
	1.5 (96 kw)	2019.01-2020.10	7AT	F	L	Estate FWD DHFA		2612820L	Drive Shaft		36		59.5	40	523
	1.5 (110 kw)	2017.02-2020.10	6MT	F	L	Estate FWD DADA/DPCA		2612820L	Drive Shaft		36		59.5	40	523
2017.02-2020.10		7DCT	F	L	Estate FWD DADA/DPCA		2611000L	Drive Shaft		36		59.5	40.5	514	
2017.02-2020.10		6MT	F	L	Hatchback FWD DADA/DPCA		2612820L	Drive Shaft		36		59.5	40	523	
2017.02-2020.10		7DCT	F	L	Hatchback FWD DADA/DPCA		2611000L	Drive Shaft		36		59.5	40.5	514	
2020.11-		7AT	F	L	Estate FWD DFYA		2611000L	Drive Shaft		36		59.5	40.5	514	
2020.11-		7AT	F	L	Hatchback FWD DFYA		2611000L	Drive Shaft		36		59.5	40.5	514	
1.6 (66 kw)	2012.11-2020.10	5MT	F	L	Estate FWD CLHB/CRKA/CXXA/DDYB	Model code:CLHB	2032940L	Drive Shaft		36		59.5	40	517	
	2012.11-2020.10	5MT	F	L	Estate FWD CLHB/CRKA/CXXA/DDYB	Model code:CRKA/CXXA	2612820L	Drive Shaft		36		59.5	40	523	
	2012.11-2020.10	5MT	F	R	Estate FWD CLHB/CRKA/CXXA/DDYB	Model code:CLHB	2610420L	Drive Shaft		36		59.5	40	814	
	2012.11-2020.10	5MT	F	R	Estate FWD CLHB/CRKA/CXXA/DDYB	Model code:CRKA/CXXA	2612830L	Drive Shaft		36		59.5	40	815	
	2012.11-2020.10	5MT	F	L	Hatchback FWD CLHB/CRKA/CXXA/DDYB	Model code:CLHB	2032940L	Drive Shaft		36		59.5	40	517	
	2012.11-2020.10	5MT	F	L	Hatchback FWD CLHB/CRKA/CXXA/DDYB	Model code:CRKA/CXXA	2612820L	Drive Shaft		36		59.5	40	523	
	2012.11-2020.10	5MT	F	R	Hatchback FWD CLHB/CRKA/CXXA/DDYB	Model code:CLHB	2610420L	Drive Shaft		36		59.5	40	814	
	2012.11-2020.10	5MT	F	R	Hatchback FWD CLHB/CRKA/CXXA/DDYB	Model code:CRKA/CXXA	2612830L	Drive Shaft		36		59.5	40	815	
1.6 (75 kw)	2004.05-2013.06	AT	F	R	Hatchback FWD BGU/BSE/BSF/CCSA/CMXA		2610940L	Drive Shaft		36	26	59.5	40	884	
	2004.05-2013.06	MT	F	L	Hatchback FWD BGU/BSE/BSF/CCSA/CMXA		2032940L	Drive Shaft		36		59.5	40	517	





  YEAR	TRANSM.	F/R	L/R	BODY STYLE & DRIVE TYPE & ENGINE	REMARKS	GSP Ref.	 PRODUCT	 ABS	Technical Specifications				
									A	B	C	H	L
SKODA													
Octavia													
1.6 (75 kw)													
2004.05-2013.06	MT	F	R	Hatchback FWD BGI/BSE/BSF/CCSA/CMXA		261096OL	Drive Shaft		36		59.5	40	800
2004.09-2013.03	AT	F	R	Estate FWD BGI/BSE/BSF/CCSA/CMXA		261094OL	Drive Shaft		36	26	59.5	40	884
2004.09-2013.03	MT	F	L	Estate FWD BGI/BSE/BSF/CCSA/CMXA		203294OL	Drive Shaft		36		59.5	40	517
2004.09-2013.03	MT	F	R	Estate FWD BGI/BSE/BSF/CCSA/CMXA		261096OL	Drive Shaft		36		59.5	40	800
2005.05-2013.03	MT	F	L	Hatchback FWD BSE/CHGA		203294OL	Drive Shaft		36		59.5	40	517
2005.05-2013.03	MT	F	R	Hatchback FWD BSE/CHGA		261096OL	Drive Shaft		36		59.5	40	800
2007.11-2012.11	5MT	F	R	Estate FWD CCSA/CMXA		261096OL	Drive Shaft		36		59.5	40	800
2007.11-2012.11	MT	F	L	Estate FWD CCSA/CMXA		203294OL	Drive Shaft		36		59.5	40	517
2008.01-2013.06	5MT	F	R	Hatchback FWD CCSA/CMXA		261096OL	Drive Shaft		36		59.5	40	800
2008.01-2013.06	MT	F	L	Hatchback FWD CCSA/CMXA		203294OL	Drive Shaft		36		59.5	40	517
2009.08-2012.11	5MT	F	R	Estate FWD CHGA		261096OL	Drive Shaft		36		59.5	40	800
2009.08-2012.11	MT	F	L	Estate FWD CHGA		203294OL	Drive Shaft		36		59.5	40	517
1.6 (77 kw)													
2009.06-2013.02	6MT	F	L	Estate 4WD CAYC		203295OL	Drive Shaft		36		59.5	40.5	486
2009.06-2013.02	6MT	F	R	Estate 4WD CAYC		203266OL	Drive Shaft		36		59.5	40.5	601
2009.06-2013.02	MT	F	L	Estate 4WD CAYC		203380OL	Drive Shaft		36		59.5	40	487
2009.06-2013.03	7DCT	F	R	Estate FWD CAYC		261096OL	Drive Shaft		36		59.5	40	800
2009.06-2013.03	AT	F	L	Estate FWD CAYC	Date From:2011.06	261282OL	Drive Shaft		36		59.5	40	523
2009.06-2013.03	AT	F	R	Estate FWD CAYC	Date To:2011.05	203313OL	Drive Shaft		36		59.5	40.5	794
2009.06-2013.03	AT	F	R	Estate FWD CAYC	Date From:2011.06	261283OL	Drive Shaft		36		59.5	40	815
2009.06-2013.03	MT	F	L	Estate FWD CAYC		203294OL	Drive Shaft		36		59.5	40	517
2009.06-2013.03	MT	F	R	Estate FWD CAYC		261042OL	Drive Shaft		36		59.5	40	814
2009.06-2013.03	Semi-AT	F	L	Estate FWD CAYC		203380OL	Drive Shaft		36		59.5	40	487
2009.06-2013.03	7AT	F	L	Hatchback FWD CAYC		203380OL	Drive Shaft		36		59.5	40	487
2009.06-2013.03	7DCT	F	R	Hatchback FWD CAYC	Date From:2011.06	261096OL	Drive Shaft		36		59.5	40	800
2009.06-2013.03	AT	F	L	Hatchback FWD CAYC	Date From:2011.06	261282OL	Drive Shaft		36		59.5	40	523
2009.06-2013.03	AT	F	R	Hatchback FWD CAYC	Date To:2011.05	203313OL	Drive Shaft		36		59.5	40.5	794
2009.06-2013.03	AT	F	R	Hatchback FWD CAYC	Date From:2011.06	261283OL	Drive Shaft		36		59.5	40	815
2009.06-2013.03	MT	F	L	Hatchback FWD CAYC		203294OL	Drive Shaft		36		59.5	40	517
2009.06-2013.03	MT	F	R	Hatchback FWD CAYC		261042OL	Drive Shaft		36		59.5	40	814
2009.06-2013.03	MT	F	R	Hatchback FWD CAYC		261042OL	Drive Shaft		36		59.5	40	814
2012.11-2015.05	5MT	F	R	Hatchback FWD CLHA		261283OL	Drive Shaft		36		59.5	40	815
2012.11-2015.05	5MT/7DCT	F	L	Hatchback FWD CLHA		261282OL	Drive Shaft		36		59.5	40	523
2012.11-2015.05	7DCT	F	R	Hatchback FWD CLHA		261096OL	Drive Shaft		36		59.5	40	800
2012.11-2015.05		F	L	Hatchback FWD CLHA		203294OL	Drive Shaft		36		59.5	40	517
2012.11-2017.02	5MT	F	R	Estate FWD CLHA		261283OL	Drive Shaft		36		59.5	40	815
2012.11-2017.02	5MT/7DCT	F	L	Estate FWD CLHA		261282OL	Drive Shaft		36		59.5	40	523
2012.11-2017.02	7DCT	F	R	Estate FWD CLHA		261096OL	Drive Shaft		36		59.5	40	800
2012.11-2017.02		F	L	Estate FWD CLHA		203294OL	Drive Shaft		36		59.5	40	517
2013.05-2015.05	MT	F	L	Estate 4WD CLHA		203294OL	Drive Shaft		36		59.5	40	517
1.6 (81 kw)													
2013.05-2017.02	5MT/6MT	F	R	Estate FWD CRKB/CXXB/DBKA		261283OL	Drive Shaft		36		59.5	40	815
2013.05-2017.02	5MT/6MT/7DCT	F	L	Estate FWD CRKB/CXXB/DBKA		261282OL	Drive Shaft		36		59.5	40	523
2013.05-2017.02	7DCT	F	R	Estate FWD CRKB/CXXB/DBKA		261096OL	Drive Shaft		36		59.5	40	800
2013.05-2017.02	MT	F	L	Estate FWD CRKB/CXXB/DBKA		203294OL	Drive Shaft		36		59.5	40	517
2013.05-2017.02	5MT/6MT	F	R	Hatchback FWD CRKB/CXXB/DBKA		261283OL	Drive Shaft		36		59.5	40	815
2013.05-2017.02	7AT/5MT/6MT	F	L	Hatchback FWD CRKB/CXXB/DBKA		261282OL	Drive Shaft		36		59.5	40	523
2013.05-2017.02	7DCT	F	R	Hatchback FWD CRKB/CXXB/DBKA		261096OL	Drive Shaft		36		59.5	40	800
2013.05-2017.02	MT	F	L	Hatchback FWD CRKB/CXXB/DBKA		203294OL	Drive Shaft		36		59.5	40	517
2014.01-2017.02	5MT	F	R	Estate FWD CWVA		261096OL	Drive Shaft		36		59.5	40	800
2014.01-2017.02	6DCT	F	R	Estate FWD CWVA		261094OL	Drive Shaft		36	26	59.5	40	884
2014.01-2017.02	MT	F	L	Estate FWD CWVA		203294OL	Drive Shaft		36		59.5	40	517
2014.01-2020.10	5MT	F	R	Hatchback FWD CWVA		261096OL	Drive Shaft		36		59.5	40	800
2014.01-2020.10	6DCT	F	R	Hatchback FWD CWVA		261094OL	Drive Shaft		36	26	59.5	40	884
2014.01-2020.10	MT	F	L	Hatchback FWD CWVA		203294OL	Drive Shaft		36		59.5	40	517
1.6 (85 kw)													
2004.02-2008.10	AT	F	R	Estate FWD BLF		261094OL	Drive Shaft		36	26	59.5	40	884
2004.02-2008.10	MT	F	R	Estate FWD BLF		261211OL	Drive Shaft		36		59.5	40.5	784
2004.02-2008.10	AT	F	R	Hatchback FWD BLF		261094OL	Drive Shaft		36	26	59.5	40	884
2004.02-2008.10	MT	F	R	Hatchback FWD BLF		261211OL	Drive Shaft		36		59.5	40.5	784
2017.02-2020.10	5MT	F	R	Estate FWD DDYA/DGTA/DGTE		261283OL	Drive Shaft		36		59.5	40	815
2017.02-2020.10	5MT/7DCT	F	L	Estate FWD DDYA/DGTA/DGTE		261282OL	Drive Shaft		36		59.5	40	523
2017.02-2020.10	7DCT	F	R	Estate FWD DDYA/DGTA/DGTE		261096OL	Drive Shaft		36		59.5	40	800
2017.02-2020.10	5MT	F	R	Hatchback FWD DDYA/DGTE		261283OL	Drive Shaft		36		59.5	40	815
2017.02-2020.10	7AT/5MT	F	L	Hatchback FWD DDYA/DGTE		261282OL	Drive Shaft		36		59.5	40	523
2017.02-2020.10	7DCT	F	R	Hatchback FWD DDYA/DGTE		261096OL	Drive Shaft		36		59.5	40	800
1.8 (112 kw)													
2009.03-2013.02	6MT	F	L	Estate 4WD CDAB		203295OL	Drive Shaft		36		59.5	40.5	486
2009.03-2013.02	6MT	F	R	Estate 4WD CDAB		203266OL	Drive Shaft		36		59.5	40.5	601
2009.03-2013.02	AT/MT	F	L	Estate 4WD CDAB		203380OL	Drive Shaft		36		59.5	40	487



  YEAR	TRANSM.	F/R	L/R	BODY STYLE & DRIVE TYPE & ENGINE	REMARKS	GSP Ref.	 PRODUCT ABS	Technical Specifications				
								A	B	C	H	L
SKODA												
Octavia												
1.8 (112 kw)	2009.03-2013.03	6AT/7AT/6MT	F	L	Estate FWD CDAB	Date To:2009.11	2611000L	Drive Shaft	36	59.5	40.5	514
	2009.03-2013.03	6AT/7AT/6MT	F	L	Estate FWD CDAB	Date From:2009.12	2612820L	Drive Shaft	36	59.5	40	523
	2009.03-2013.03	6AT/7AT/6MT	F	R	Estate FWD CDAB		2613410L	Drive Shaft	36	59.5	40.5	806
	2009.03-2013.03	AT	F	L	Estate FWD CDAB		2033800L	Drive Shaft	36	59.5	40	487
	2009.03-2013.03	MT	F	L	Estate FWD CDAB		2032940L	Drive Shaft	36	59.5	40	517
	2009.03-2013.03	6AT/7AT/6MT	F	L	Hatchback FWD CDAB	Date To:2009.11	2611000L	Drive Shaft	36	59.5	40.5	514
	2009.03-2013.03	6AT/7AT/6MT	F	L	Hatchback FWD CDAB	Date From:2009.12	2612820L	Drive Shaft	36	59.5	40	523
	2009.03-2013.03	6AT/7AT/6MT	F	R	Hatchback FWD CDAB		2613410L	Drive Shaft	36	59.5	40.5	806
	2009.03-2013.03	AT	F	L	Hatchback FWD CDAB		2033800L	Drive Shaft	36	59.5	40	487
	2009.03-2013.03	MT	F	L	Hatchback FWD CDAB		2032940L	Drive Shaft	36	59.5	40	517
1.8 (118 kw)	2007.06-2013.03	AT	F	L	Estate FWD BZB/CDA		2033800L	Drive Shaft	36	59.5	40	487
	2007.06-2013.03	AT	F	L	Estate FWD BZB/CDA		2611000L	Drive Shaft	36	59.5	40.5	514
	2007.06-2013.03	AT	F	R	Estate FWD BZB/CDA		2033130L	Drive Shaft	36	59.5	40.5	794
	2007.06-2013.03	MT	F	L	Estate FWD BZB/CDA		2032940L	Drive Shaft	36	59.5	40	517
	2007.06-2013.03	MT	F	L	Estate FWD BZB/CDA	Date From:2009.11	2612820L	Drive Shaft	36	59.5	40	523
	2007.06-2013.03	MT	F	R	Estate FWD BZB/CDA		2613410L	Drive Shaft	36	59.5	40.5	806
	2007.06-2013.03	AT	F	R	Hatchback FWD BZB/CDA		2033130L	Drive Shaft	36	59.5	40.5	794
	2007.06-2013.03	AT/MT	F	L	Hatchback FWD BZB/CDA		2611000L	Drive Shaft	36	59.5	40.5	514
	2007.06-2013.03	MT	F	L	Hatchback FWD BZB/CDA		2032940L	Drive Shaft	36	59.5	40	517
	2007.06-2013.03	MT	F	L	Hatchback FWD BZB/CDA		2033800L	Drive Shaft	36	59.5	40	487
	2007.06-2013.03	MT	F	R	Hatchback FWD BZB/CDA		2613410L	Drive Shaft	36	59.5	40.5	806
	2008.11-2013.02	6MT	F	L	Estate 4WD CDA		2611000L	Drive Shaft	36	59.5	40.5	514
	2008.11-2013.02	6MT	F	R	Estate 4WD CDA		2033130L	Drive Shaft	36	59.5	40.5	794
	2008.11-2013.02	7AT/6MT	F	L	Estate 4WD CDA		2032950L	Drive Shaft	36	59.5	40.5	486
	2008.11-2013.02	7AT/6MT	F	R	Estate 4WD CDA		2032660L	Drive Shaft	36	59.5	40.5	601
	2008.11-2013.02	AT/MT	F	L	Estate 4WD CDA		2033800L	Drive Shaft	36	59.5	40	487
1.8 (132 kw)	2012.11-2020.10	6MT	F	L	Estate FWD CJS/CJSB		2611000L	Drive Shaft	36	59.5	40.5	514
	2012.11-2020.10	6MT	F	R	Estate FWD CJS/CJSB		2613410L	Drive Shaft	36	59.5	40.5	806
	2012.11-2020.10	7DCT	F	R	Estate FWD CJS/CJSB		2033130L	Drive Shaft	36	59.5	40.5	794
	2012.11-2020.10	6MT	F	L	Hatchback FWD CJS		2611000L	Drive Shaft	36	59.5	40.5	514
1.9 (77 kw)	2004.02-2013.04	AT	F	L	Hatchback FWD BJB/BKC/BLS/BXE		2540130L	Drive Shaft	36	59.5	40.5	482
	2004.02-2013.04	AT	F	R	Hatchback FWD BJB/BKC/BLS/BXE		2540110L	Drive Shaft	36	59.5	40.5	760
	2004.02-2013.04	MT	F	L	Hatchback FWD BJB/BKC/BLS/BXE		2032940L	Drive Shaft	36	59.5	40	517
	2004.02-2013.04	MT	F	R	Hatchback FWD BJB/BKC/BLS/BXE		2610420L	Drive Shaft	36	59.5	40	814
	2004.09-2010.12	AT	F	L	Estate FWD BJB/BKC/BLS/BXE		2540130L	Drive Shaft	36	59.5	40.5	482
	2004.09-2010.12	AT	F	R	Estate FWD BJB/BKC/BLS/BXE		2540110L	Drive Shaft	36	59.5	40.5	760
	2004.09-2010.12	MT	F	L	Estate FWD BJB/BKC/BLS/BXE		2032940L	Drive Shaft	36	59.5	40	517
	2004.09-2010.12	MT	F	R	Estate FWD BJB/BKC/BLS/BXE		2610420L	Drive Shaft	36	59.5	40	814
	2004.11-2010.12	6MT	F	L	Estate 4WD BKC/BLS/BXE		2032950L	Drive Shaft	36	59.5	40.5	486
	2004.11-2010.12	6MT	F	R	Estate 4WD BKC/BLS/BXE		2032660L	Drive Shaft	36	59.5	40.5	601
	2004.11-2010.12	MT	F	L	Estate 4WD BKC/BLS/BXE		2032940L	Drive Shaft	36	59.5	40	517
	2004.11-2010.12	MT	F	L	Estate 4WD BKC/BLS/BXE		2033800L	Drive Shaft	36	59.5	40	487
	2004.11-2010.12	MT	F	R	Estate 4WD BKC/BLS/BXE		2610420L	Drive Shaft	36	59.5	40	814
2.0 (81 kw)	2010.03-2013.03	5MT/6MT	F	L	Estate FWD CFHF/CLCA		2032940L	Drive Shaft	36	59.5	40	517
	2010.03-2013.03	5MT/6MT	F	R	Estate FWD CFHF/CLCA		2610420L	Drive Shaft	36	59.5	40	814
	2010.03-2013.03		F	L	Estate FWD CFHF/CLCA		2033800L	Drive Shaft	36	59.5	40	487
	2010.03-2013.03	6AT/5MT/6MT	F	L	Hatchback FWD CFHF/CLCA		2032940L	Drive Shaft	36	59.5	40	517
	2010.03-2013.03	6AT/5MT/6MT	F	R	Hatchback FWD CFHF/CLCA		2610420L	Drive Shaft	36	59.5	40	814
	2010.03-2013.03	MT	F	L	Hatchback FWD CFHF/CLCA		2033800L	Drive Shaft	36	59.5	40	487
	2010.03-2013.03		F	R	Hatchback FWD CFHF/CLCA		2540110L	Drive Shaft	36	59.5	40.5	760
	2011.05-2013.02	6MT	F	L	Estate 4WD CFHF		2032950L	Drive Shaft	36	59.5	40.5	486
	2011.05-2013.02	6MT	F	R	Estate 4WD CFHF		2033130L	Drive Shaft	36	59.5	40.5	794
	2011.05-2013.02	MT	F	L	Estate 4WD CFHF		2033800L	Drive Shaft	36	59.5	40	487
2.0 (100 kw)	2004.02-2010.05	AT	F	L	Estate FWD AZV	Date To:2004.10	2540130L	Drive Shaft	36	59.5	40.5	482
	2004.02-2010.05	AT	F	R	Estate FWD AZV	Date From:2004.11	2540110L	Drive Shaft	36	59.5	40.5	760
	2004.02-2010.05	MT	F	L	Estate FWD AZV	Date From:2004.11	2032950L	Drive Shaft	36	59.5	40.5	486
	2004.02-2010.05	MT	F	R	Estate FWD AZV	Date From:2004.11	2033130L	Drive Shaft	36	59.5	40.5	794
	2004.02-2010.05	MT	F	L/R	Estate FWD AZV	Date To:2004.10	2032950L	Drive Shaft	36	59.5	40.5	486
	2004.02-2010.05		F	L	Estate FWD AZV		2033800L	Drive Shaft	36	59.5	40	487
	2004.02-2010.05	AT	F	L	Hatchback FWD AZV		2540130L	Drive Shaft	36	59.5	40.5	482
	2004.02-2010.05	AT	F	R	Hatchback FWD AZV		2540110L	Drive Shaft	36	59.5	40.5	760
	2004.02-2010.05	MT	F	L	Hatchback FWD AZV		2032950L	Drive Shaft	36	59.5	40.5	486
	2004.02-2010.05	MT	F	R	Hatchback FWD AZV		2033130L	Drive Shaft	36	59.5	40.5	794
	2004.02-2010.05	MT	F	R	Hatchback FWD AZV		2033800L	Drive Shaft	36	59.5	40	487
2.0 (103 kw)	2004.02-2013.03	AT	F	L	Estate FWD BKD/CFHC/CLCB	For Engine Code:BKD.Date To:2004.10	2540130L	Drive Shaft	36	59.5	40.5	482





  YEAR	TRANSM.	F/R	L/R	BODY STYLE & DRIVE TYPE & ENGINE	REMARKS	GSP Ref.	 PRODUCT	 ABS	Technical Specifications				
									A	B	C	H	L
SKODA													
Octavia													
2.0 (103 kw)													
2004.02-2013.03	AT	F	L	Estate FWD BKD/CFHC/CLCB	For Engine Code:CFHC/CLCB	2540130L	Drive Shaft		36	59.5	40.5	482	
2004.02-2013.03	AT	F	R	Estate FWD BKD/CFHC/CLCB	For Engine Code:CFHC/CLCB	2540110L	Drive Shaft		36	59.5	40.5	760	
2004.02-2013.03	AT	F	L/R	Estate FWD BKD/CFHC/CLCB	For Engine Code:BKD,Date From:2004.11	2540110L	Drive Shaft		36	59.5	40.5	760	
2004.02-2013.03	MT	F	L	Estate FWD BKD/CFHC/CLCB	For Engine Code:CFHC,For PR code:1PD/1PF	2032950L	Drive Shaft		36	59.5	40.5	486	
2004.02-2013.03	MT	F	L	Estate FWD BKD/CFHC/CLCB	For Engine Code:CFHC,For PR code:1PA	2033800L	Drive Shaft		36	59.5	40	487	
2004.02-2013.03	MT	F	R	Estate FWD BKD/CFHC/CLCB		2033130L	Drive Shaft		36	59.5	40.5	794	
2004.02-2013.03		F	L	Estate FWD BKD/CFHC/CLCB		2033800L	Drive Shaft		36	59.5	40	487	
2004.02-2013.05	AT	F	L	Hatchback FWD BKD/CFHC/CLCB		2033810L	Drive Shaft		36	59.5	40	485	
2004.02-2013.05	AT	F	L	Hatchback FWD BKD/CFHC/CLCB		2540130L	Drive Shaft		36	59.5	40.5	482	
2004.02-2013.05	AT	F	R	Hatchback FWD BKD/CFHC/CLCB		2540110L	Drive Shaft		36	59.5	40.5	760	
2004.02-2013.05	MT	F	L	Hatchback FWD BKD/CFHC/CLCB		2032950L	Drive Shaft		36	59.5	40.5	486	
2004.02-2013.05	MT	F	R	Hatchback FWD BKD/CFHC/CLCB		2033130L	Drive Shaft		36	59.5	40.5	794	
2004.02-2013.05	MT	F	R	Hatchback FWD BKD/CFHC/CLCB		2033800L	Drive Shaft		36	59.5	40	487	
2005.11-2010.05	AT	F	L	Estate FWD BMM		2540130L	Drive Shaft		36	59.5	40.5	482	
2005.11-2010.05	AT	F	R	Estate FWD BMM		2540110L	Drive Shaft		36	59.5	40.5	760	
2005.11-2010.05	MT	F	L	Estate FWD BMM		2032950L	Drive Shaft		36	59.5	40.5	486	
2005.11-2010.05	MT	F	R	Estate FWD BMM		2033130L	Drive Shaft		36	59.5	40.5	794	
2005.11-2010.05		F	L	Estate FWD BMM		2033800L	Drive Shaft		36	59.5	40	487	
2005.11-2010.05	AT	F	L	Hatchback FWD BMM		2540130L	Drive Shaft		36	59.5	40.5	482	
2005.11-2010.05	AT	F	R	Hatchback FWD BMM		2540110L	Drive Shaft		36	59.5	40.5	760	
2005.11-2010.05	MT	F	L	Hatchback FWD BMM		2032950L	Drive Shaft		36	59.5	40.5	486	
2005.11-2010.05	MT	F	L	Hatchback FWD BMM		2033800L	Drive Shaft		36	59.5	40	487	
2005.11-2010.05	MT	F	R	Hatchback FWD BMM		2033130L	Drive Shaft		36	59.5	40.5	794	
2006.07-2010.05	6MT	F	L	Estate 4WD BMM		2032950L	Drive Shaft		36	59.5	40.5	486	
2006.07-2010.05	6MT	F	R	Estate 4WD BMM		2032660L	Drive Shaft		36	59.5	40.5	601	
2006.07-2010.05	MT	F	L	Estate 4WD BMM		2033800L	Drive Shaft		36	59.5	40	487	
2010.05-2013.02	AT/MT	F	L	Estate 4WD CFHC		2032950L	Drive Shaft		36	59.5	40.5	486	
2010.05-2013.02	AT/MT	F	R	Estate 4WD CFHC	Model:Octavia Scout	2032660L	Drive Shaft		36	59.5	40.5	601	
2010.05-2013.02	AT/MT	F	R	Estate 4WD CFHC		2033130L	Drive Shaft		36	59.5	40.5	794	
2010.05-2013.02	MT	F	L	Estate 4WD CFHC		2033800L	Drive Shaft		36	59.5	40	487	
2.0 (105 kw)													
2012.11-2017.02	6DCT	F	L	Estate FWD CKFB/CRVC		2612850L	Drive Shaft		36	59.5	40	472	
2012.11-2017.02	6DCT	F	R	Estate FWD CKFB/CRVC		2033540L	Drive Shaft		36	59.5	40	760	
2012.11-2017.02	6MT	F	R	Estate FWD CKFB/CRVC		2033130L	Drive Shaft		36	59.5	40.5	794	
2012.11-2017.02	6DCT	F	L	Hatchback FWD CKFB/CRVC		2612850L	Drive Shaft		36	59.5	40	472	
2012.11-2017.02	6DCT	F	R	Hatchback FWD CKFB/CRVC		2033540L	Drive Shaft		36	59.5	40	760	
2012.11-2017.02	6MT	F	R	Hatchback FWD CKFB/CRVC		2033130L	Drive Shaft		36	59.5	40.5	794	
2.0 (110 kw)													
2004.11-2008.10	6MT	F	L	Estate 4WD BLX/BVX		2032940L	Drive Shaft		36	59.5	40	517	
2004.11-2008.10	6MT	F	R	Estate 4WD BLX/BVX		2610960L	Drive Shaft		36	59.5	40	800	
2004.11-2008.10	AT	F	R	Estate FWD BLR/BLY/BVY/BVZ		2610940L	Drive Shaft		36	26	59.5	40	884
2004.11-2008.10	MT	F	L	Estate FWD BLR/BLY/BVY/BVZ		2032940L	Drive Shaft		36	59.5	40	517	
2004.11-2008.10	MT	F	R	Estate FWD BLR/BLY/BVY/BVZ		2610420L	Drive Shaft		36	59.5	40	814	
2004.11-2008.10	AT	F	R	Hatchback FWD BLR/BLY/BVY/BVZ		2610940L	Drive Shaft		36	26	59.5	40	884
2004.11-2008.10	MT	F	L	Hatchback FWD BLR/BLY/BVY/BVZ		2032940L	Drive Shaft		36	59.5	40	517	
2004.11-2008.10	MT	F	R	Hatchback FWD BLR/BLY/BVY/BVZ		2610420L	Drive Shaft		36	59.5	40	814	
2012.11-2020.10	6DCT	F	L	Estate FWD CKFC/CRMB/CYKA/DCYA/DFFA		2612850L	Drive Shaft		36	59.5	40	472	
2012.11-2020.10	6DCT	F	R	Estate FWD CKFC/CRMB/CYKA/DCYA/DFFA		2033540L	Drive Shaft		36	59.5	40	760	
2012.11-2020.10	6MT	F	R	Estate FWD CKFC/CRMB/CYKA/DCYA/DFFA		2033130L	Drive Shaft		36	59.5	40.5	794	
2012.11-2020.10	6DCT	F	L	Hatchback FWD CKFC/CRMB/CYKA/DCYA/DFFA		2612850L	Drive Shaft		36	59.5	40	472	
2012.11-2020.10	6DCT	F	R	Hatchback FWD CKFC/CRMB/CYKA/DCYA/DFFA		2033540L	Drive Shaft		36	59.5	40	760	
2012.11-2020.10	6MT	F	R	Hatchback FWD CKFC/CRMB/CYKA/DCYA/DFFA		2033130L	Drive Shaft		36	59.5	40.5	794	
2012.11-2020.10	7DCT	F	L	Hatchback FWD CKFC/CRMB/CYKA/DCYA/DFFA		2012650L	Drive Shaft		36	37	59.5	40	558
2012.11-2020.10	AT	F	R	Hatchback FWD CKFC/CRMB/CYKA/DCYA/DFFA		2540110L	Drive Shaft		36	59.5	40.5	760	
2013.05-	7DCT	F	L	Estate 4WD CKFC/CRMB/DCYA		2012650L	Drive Shaft		36	37	59.5	40	558
2019.11-	7DCT	F	L	Estate FWD DSTA/DSTB/DTTA/DTTC	For PR code:0UJ,Trans. code:DQ381	2012650L	Drive Shaft		36	37	59.5	40	558
2019.11-	7DCT	F	L	Estate FWD DSTA/DSTB/DTTA/DTTC	For PR code:0EG,Trans. code:DQ200	2612820L	Drive Shaft		36	59.5	40	523	
2020.01-	7DCT	F	L	Hatchback FWD DSTA/DSTB/DTTA/DTTC	For PR code:0UJ,Trans. code:DQ381	2012650L	Drive Shaft		36	37	59.5	40	558
2020.01-	7DCT	F	L	Hatchback FWD DSTA/DSTB/DTTA/DTTC	For PR code:0EG,Trans. code:DQ200	2612820L	Drive Shaft		36	59.5	40	523	
2.0 (125 kw)													
2006.04-2013.02	AT	F	L	Estate FWD BMN/CEGA		2033810L	Drive Shaft		36	59.5	40	485	
2006.04-2013.02	AT	F	L	Estate FWD BMN/CEGA		2540130L	Drive Shaft		36	59.5	40.5	482	
2006.04-2013.02	AT	F	R	Estate FWD BMN/CEGA		2540110L	Drive Shaft		36	59.5	40.5	760	
2006.04-2013.02	MT	F	L	Estate FWD BMN/CEGA		2032950L	Drive Shaft		36	59.5	40.5	486	
2006.04-2013.02	MT	F	L	Estate FWD BMN/CEGA		2033800L	Drive Shaft		36	59.5	40	487	
2006.04-2013.02	MT	F	R	Estate FWD BMN/CEGA		2033130L	Drive Shaft		36	59.5	40.5	794	
2006.04-2013.02		F	R	Estate FWD BMN/CEGA	Date From:2008.06,For Engine Code:BMN	2611470L	Drive Shaft		36	59.5	40.5	795	
2006.04-2013.02	AT	F	L	Hatchback FWD BMN/CEGA		2033810L	Drive Shaft		36	59.5	40	485	



 YEAR	TRANSM.	F/R	L/R	BODY STYLE & DRIVE TYPE & ENGINE	REMARKS	GSP Ref.	 PRODUCT	 ABS	Technical Specifications				
									A	B	C	H	L
SKODA Octavia													
2.0 (125 kw)	2006.04-2013.02	AT	F	L	Hatchback FWD BMN/CEGA	2540130L	Drive Shaft		36		59.5	40.5	482
	2006.04-2013.02	AT	F	R	Hatchback FWD BMN/CEGA	2540110L	Drive Shaft		36		59.5	40.5	760
	2006.04-2013.02	MT	F	L	Hatchback FWD BMN/CEGA	2032950L	Drive Shaft		36		59.5	40.5	486
	2006.04-2013.02	MT	F	L	Hatchback FWD BMN/CEGA	2033800L	Drive Shaft		36		59.5	40	487
	2006.04-2013.02	MT	F	R	Hatchback FWD BMN/CEGA	2033130L	Drive Shaft		36		59.5	40.5	794
	2006.04-2013.02		F	R	Hatchback FWD BMN/CEGA	2611470L	Drive Shaft		36		59.5	40.5	795
2.0 (135 kw)	2013.05-	6DCT	F	L	Estate 4WD CUNA	2612850L	Drive Shaft		36		59.5	40	472
	2013.05-	7DCT	F	L	Estate 4WD CUNA	2012650L	Drive Shaft		36	37	59.5	40	558
	2013.05-2020.10	6DCT	F	L	Estate FWD CUNA/CUPA/DJGA	2612850L	Drive Shaft		36		59.5	40	472
	2013.05-2020.10	6DCT	F	R	Estate FWD CUNA/CUPA/DJGA	2033540L	Drive Shaft		36		59.5	40	760
	2013.05-2020.10	6MT	F	L	Estate FWD CUNA/CUPA/DJGA	2032950L	Drive Shaft		36		59.5	40.5	486
	2013.05-2020.10	7DCT	F	L	Estate FWD CUNA/CUPA/DJGA	2012650L	Drive Shaft		36	37	59.5	40	558
	2013.05-2020.10	6AT	F	L	Hatchback 4WD CUNA/CUPA/DJGA	2612850L	Drive Shaft		36		59.5	40	472
	2013.05-2020.10	6DCT	F	L	Hatchback FWD CUNA/CUPA/DJGA	2612850L	Drive Shaft		36		59.5	40	472
	2013.05-2020.10	6DCT	F	R	Hatchback FWD CUNA/CUPA/DJGA	2033540L	Drive Shaft		36		59.5	40	760
2.0 (147 kw)	2005.10-2013.02	AT	F	R	Estate FWD BWA/CCZA	2016530L	Drive Shaft		36		59.5	40.5	785
	2005.10-2013.02	AT/MT	F	L	Estate FWD BWA/CCZA	2032950L	Drive Shaft		36		59.5	40.5	486
	2005.10-2013.02	AT/MT	F	L	Estate FWD BWA/CCZA	2033800L	Drive Shaft		36		59.5	40	487
	2005.10-2013.02	MT	F	R	Estate FWD BWA/CCZA	2033130L	Drive Shaft		36		59.5	40.5	794
	2005.10-2013.02	AT	F	R	Hatchback FWD BWA/CCZA	2016530L	Drive Shaft		36		59.5	40.5	785
	2005.10-2013.02	AT/MT	F	L	Hatchback FWD BWA/CCZA	2032950L	Drive Shaft		36		59.5	40.5	486
	2005.10-2013.02	AT/MT	F	L	Hatchback FWD BWA/CCZA	2033800L	Drive Shaft		36		59.5	40	487
	2005.10-2013.02	MT	F	R	Hatchback FWD BWA/CCZA	2033130L	Drive Shaft		36		59.5	40.5	794
Octavia Scout													
1.8 (112 kw)	2009.03-2009.05	6MT	F	L	Estate 4WD CDAB	2032950L	Drive Shaft		36		59.5	40.5	486
	2009.03-2009.05	6MT	F	R	Estate 4WD CDAB	2032660L	Drive Shaft		36		59.5	40.5	601
	2009.03-2009.05	AT/MT	F	L	Estate 4WD CDAB	2033800L	Drive Shaft		36		59.5	40	487
1.8 (118 kw)	2008.11-2013.02	6MT	F	L	Estate 4WD CDAA	2611000L	Drive Shaft		36		59.5	40.5	514
	2008.11-2013.02	6MT	F	R	Estate 4WD CDAA	2033130L	Drive Shaft		36		59.5	40.5	794
	2008.11-2013.02	7AT/6MT	F	L	Estate 4WD CDAA	2032950L	Drive Shaft		36		59.5	40.5	486
	2008.11-2013.02	7AT/6MT	F	R	Estate 4WD CDAA	2032660L	Drive Shaft		36		59.5	40.5	601
	2008.11-2013.02	AT/MT	F	L	Estate 4WD CDAA	2033800L	Drive Shaft		36		59.5	40	487
2.0 (103 kw)	2004.02-2013.03	AT/MT	F	L	Estate 4WD BKD/CFHC/CLCB	2032950L	Drive Shaft		36		59.5	40.5	486
	2004.02-2013.03	AT/MT	F	R	Estate 4WD BKD/CFHC/CLCB	2032660L	Drive Shaft		36		59.5	40.5	601
	2004.02-2013.03	AT/MT	F	R	Estate 4WD BKD/CFHC/CLCB	2033130L	Drive Shaft		36		59.5	40.5	794
	2004.02-2013.03	MT	F	L	Estate 4WD BKD/CFHC/CLCB	2033800L	Drive Shaft		36		59.5	40	487
	2006.10-2010.05	6MT	F	L	Estate 4WD BMM	2032950L	Drive Shaft		36		59.5	40.5	486
	2006.10-2010.05	6MT	F	R	Estate 4WD BMM	2032660L	Drive Shaft		36		59.5	40.5	601
	2006.10-2010.05	MT	F	L	Estate 4WD BMM	2033800L	Drive Shaft		36		59.5	40	487
2.0 (110 kw)	2004.11-2009.04	6MT	F	L	Estate 4WD BLX/BLY/BVX	2032940L	Drive Shaft		36		59.5	40	517
	2004.11-2009.04	6MT	F	R	Estate 4WD BLX/BLY/BVX	2610960L	Drive Shaft		36		59.5	40	800
	2012.11-	7DCT	F	L	Estate 4WD CKFC/CRMB/DCYA/DFFA	2012650L	Drive Shaft		36	37	59.5	40	558
2.0 (135 kw)	2013.05-	6DCT	F	L	Estate 4WD CUNA/CUPA/DJGA	2612850L	Drive Shaft		36		59.5	40	472
	2013.05-	7DCT	F	L	Estate 4WD CUNA/CUPA/DJGA	2012650L	Drive Shaft		36	37	59.5	40	558
Superb													
1.4 (92 kw)	2008.08-2015.05	6MT	F	L	Estate FWD CAXC	2612010L	Drive Shaft		36		59.5	40	536
	2008.08-2015.05	MT	F	R	Estate FWD CAXC	2610960L	Drive Shaft		36		59.5	40	800
	2008.08-2015.05	6MT	F	L	Hatchback FWD CAXC	2612010L	Drive Shaft		36		59.5	40	536
	2008.08-2015.05	MT	F	R	Hatchback FWD CAXC	2610960L	Drive Shaft		36		59.5	40	800
1.4 (110 kw)	2015.03-	6MT	F	L	Estate 4WD CZEA	2018960L	Drive Shaft		36		59.5	40	500
	2015.03-	6MT	F	L	Hatchback 4WD CZEA	2018960L	Drive Shaft		36		59.5	40	500
1.6 (77 kw)	2010.09-2015.05	5MT/6MT	F	L	Estate FWD CAYC	2612820L	Drive Shaft		36		59.5	40	523
	2010.09-2015.05	5MT/6MT	F	R	Estate FWD CAYC	2610420L	Drive Shaft		36		59.5	40	814
	2010.09-2015.05	5MT/6MT	F	R	Estate FWD CAYC	2612830L	Drive Shaft		36		59.5	40	815
	2010.09-2015.05	7DCT	F	L	Estate FWD CAYC	2611000L	Drive Shaft		36		59.5	40.5	514
	2010.09-2015.05	7DCT	F	R	Estate FWD CAYC	2033130L	Drive Shaft		36		59.5	40.5	794
	2010.09-2015.05	MT	F	L	Estate FWD CAYC	2032940L	Drive Shaft		36		59.5	40	517
	2010.09-2015.05	5MT/6MT	F	L	Hatchback FWD CAYC	2612820L	Drive Shaft		36		59.5	40	523
	2010.09-2015.05	5MT/6MT	F	R	Hatchback FWD CAYC	2610420L	Drive Shaft		36		59.5	40	814
	2010.09-2015.05	5MT/6MT	F	R	Hatchback FWD CAYC	2612830L	Drive Shaft		36		59.5	40	815
	2010.09-2015.05	7DCT	F	L	Hatchback FWD CAYC	2611000L	Drive Shaft		36		59.5	40.5	514
	2010.09-2015.05	7DCT	F	R	Hatchback FWD CAYC	2033130L	Drive Shaft		36		59.5	40.5	794
	2010.09-2015.05	MT	F	L	Hatchback FWD CAYC	2032940L	Drive Shaft		36		59.5	40	517
1.6 (88 kw)	2015.03-	6MT/7DCT	F	L	Estate FWD DCXA/DCZA	2612010L	Drive Shaft		36		59.5	40	536
	2015.03-	7DCT	F	R	Estate FWD DCXA/DCZA	2612830L	Drive Shaft		36		59.5	40	815



	 YEAR	TRANSM.	F/R	L/R	BODY STYLE & DRIVE TYPE & ENGINE	REMARKS	GSP Ref.	 PRODUCT	 ABS	Technical Specifications				
										A	B	C	H	L
SKODA Superb	2015.03-	6MT/7DCT	F	L	Hatchback FWD DCXA/DCZA		2612010L	Drive Shaft		36		59.5	40	536
	2015.03-	7DCT	F	R	Hatchback FWD DCXA/DCZA		2612830L	Drive Shaft		36		59.5	40	815
1.8 (112 kw)	2009.03-2015.05	6MT	F	L	Estate 4WD CDAB		2032950L	Drive Shaft		36		59.5	40.5	486
	2009.03-2015.05	6MT	F	R	Estate 4WD CDAB		2032660L	Drive Shaft		36		59.5	40.5	601
	2009.03-2015.05	6MT	F	R	Estate FWD CDAB		2613410L	Drive Shaft		36		59.5	40.5	806
	2009.03-2015.05	6MT/7DCT	F	L	Estate FWD CDAB		2611000L	Drive Shaft		36		59.5	40.5	514
	2009.03-2015.05	7DCT	F	R	Estate FWD CDAB		2033130L	Drive Shaft		36		59.5	40.5	794
	2009.03-2015.05	AT	F	L	Estate FWD CDAB		2033800L	Drive Shaft		36		59.5	40	487
	2009.03-2015.05	6MT	F	L	Hatchback 4WD CDAB		2032950L	Drive Shaft		36		59.5	40.5	486
	2009.03-2015.05	6MT	F	R	Hatchback 4WD CDAB		2032660L	Drive Shaft		36		59.5	40.5	601
	2009.03-2015.05	6MT	F	R	Hatchback FWD CDAB		2613410L	Drive Shaft		36		59.5	40.5	806
	2009.03-2015.05	6MT/7DCT	F	L	Hatchback FWD CDAB		2611000L	Drive Shaft		36		59.5	40.5	514
	2009.03-2015.05	7DCT	F	R	Hatchback FWD CDAB		2033130L	Drive Shaft		36		59.5	40.5	794
	2009.03-2015.05	AT	F	L	Hatchback FWD CDAB		2033800L	Drive Shaft		36		59.5	40	487
	1.8 (118 kw)	2008.03-2015.05	6MT	F	L	Hatchback FWD BZB/CDA		2611000L	Drive Shaft		36		59.5	40.5
2008.03-2015.05		6MT	F	R	Hatchback FWD BZB/CDA		2613410L	Drive Shaft		36		59.5	40.5	806
2008.03-2015.05		7DCT	F	L	Hatchback FWD BZB/CDA	Date From:2008.11	2611000L	Drive Shaft		36		59.5	40.5	514
2008.03-2015.05		7DCT	F	R	Hatchback FWD BZB/CDA	Date From:2008.11	2033130L	Drive Shaft		36		59.5	40.5	794
2008.03-2015.05		7DCT	F	R	Hatchback FWD BZB/CDA	Date To:2008.10	2611470L	Drive Shaft		36		59.5	40.5	795
2008.03-2015.05		AT	F	L	Hatchback FWD BZB/CDA		2033800L	Drive Shaft		36		59.5	40	487
2008.11-2015.05		6MT	F	L	Hatchback 4WD CDA		2032950L	Drive Shaft		36		59.5	40.5	486
2008.11-2015.05		6MT	F	R	Hatchback 4WD CDA		2032660L	Drive Shaft		36		59.5	40.5	601
2008.11-2015.05		AT	F	L	Hatchback 4WD CDA		2033800L	Drive Shaft		36		59.5	40	487
2008.11-2015.05		MT	F	L	Hatchback 4WD CDA		2611000L	Drive Shaft		36		59.5	40.5	514
2009.10-2015.05		6MT	F	L	Estate 4WD CDA		2032950L	Drive Shaft		36		59.5	40.5	486
2009.10-2015.05		6MT	F	R	Estate 4WD CDA		2032660L	Drive Shaft		36		59.5	40.5	601
2009.10-2015.05		AT	F	L	Estate 4WD CDA		2033800L	Drive Shaft		36		59.5	40	487
2009.10-2015.05		MT	F	L	Estate 4WD CDA		2611000L	Drive Shaft		36		59.5	40.5	514
2009.10-2015.05		6MT	F	R	Estate FWD CDA		2613410L	Drive Shaft		36		59.5	40.5	806
2009.10-2015.05		6MT/7DCT	F	L	Estate FWD CDA		2611000L	Drive Shaft		36		59.5	40.5	514
2009.10-2015.05		7DCT	F	R	Estate FWD CDA		2033130L	Drive Shaft		36		59.5	40.5	794
2009.10-2015.05		AT	F	L	Estate FWD CDA		2033800L	Drive Shaft		36		59.5	40	487
1.8 (132 kw)		2015.03-	6MT	F	L	Estate FWD CJA/CJSC		2611000L	Drive Shaft		36		59.5	40.5
	2015.03-	7DCT	F	R	Estate FWD CJA/CJSC		2613410L	Drive Shaft		36		59.5	40.5	806
	2015.03-	6MT	F	L	Hatchback FWD CJA/CJSC		2611000L	Drive Shaft		36		59.5	40.5	514
	2015.03-	7DCT	F	R	Hatchback FWD CJA/CJSC		2613410L	Drive Shaft		36		59.5	40.5	806
1.9 (77 kw)	2008.03-2010.11	5MT	F	L	Estate FWD BLS/BXE		2032940L	Drive Shaft		36		59.5	40	517
	2008.03-2010.11	5MT	F	R	Estate FWD BLS/BXE		2610420L	Drive Shaft		36		59.5	40	814
	2008.03-2010.11	5MT	F	L	Hatchback FWD BLS/BXE		2032940L	Drive Shaft		36		59.5	40	517
	2008.03-2010.11	5MT	F	R	Hatchback FWD BLS/BXE		2610420L	Drive Shaft		36		59.5	40	814
2.0 (103 kw)	2008.03-2010.03	6DCT	F	L	Estate FWD BMP		2540130L	Drive Shaft		36		59.5	40.5	482
	2008.03-2010.03	6DCT	F	R	Estate FWD BMP		2540110L	Drive Shaft		36		59.5	40.5	760
	2008.03-2010.03	6MT	F	L	Estate FWD BMP		2032950L	Drive Shaft		36		59.5	40.5	486
	2008.03-2010.03	6MT	F	R	Estate FWD BMP		2033130L	Drive Shaft		36		59.5	40.5	794
	2008.03-2010.03	6MT	F	R	Estate FWD BMP		2611470L	Drive Shaft		36		59.5	40.5	795
	2008.03-2010.03	MT	F	L	Estate FWD BMP		2033800L	Drive Shaft		36		59.5	40	487
	2008.03-2010.03	6DCT	F	L	Hatchback FWD BMP		2540130L	Drive Shaft		36		59.5	40.5	482
	2008.03-2010.03	6DCT	F	R	Hatchback FWD BMP		2540110L	Drive Shaft		36		59.5	40.5	760
	2008.03-2010.03	6MT	F	L	Hatchback FWD BMP		2032950L	Drive Shaft		36		59.5	40.5	486
	2008.03-2010.03	6MT	F	R	Hatchback FWD BMP		2033130L	Drive Shaft		36		59.5	40.5	794
	2008.03-2010.03	6MT	F	R	Hatchback FWD BMP		2611470L	Drive Shaft		36		59.5	40.5	795
	2008.03-2010.03	MT	F	L	Hatchback FWD BMP		2033800L	Drive Shaft		36		59.5	40	487
	2009.01-2015.05	6DCT	F	L	Hatchback FWD BKD/CFFB/CLJA		2540130L	Drive Shaft		36		59.5	40.5	482
	2009.01-2015.05	6DCT	F	R	Hatchback FWD BKD/CFFB/CLJA		2540110L	Drive Shaft		36		59.5	40.5	760
	2009.01-2015.05	6MT	F	R	Hatchback FWD BKD/CFFB/CLJA		2033130L	Drive Shaft		36		59.5	40.5	794
	2009.01-2015.05	6MT	F	R	Hatchback FWD BKD/CFFB/CLJA		2611470L	Drive Shaft		36		59.5	40.5	795
	2009.01-2015.05	MT	F	L	Hatchback FWD BKD/CFFB/CLJA		2032950L	Drive Shaft		36		59.5	40.5	486
	2009.01-2015.05	MT/6MT	F	L	Hatchback FWD BKD/CFFB/CLJA		2033800L	Drive Shaft		36		59.5	40	487
	2009.10-2015.05	6DCT	F	L	Estate FWD BKD/CFFB/CLJA		2540130L	Drive Shaft		36		59.5	40.5	482
	2009.10-2015.05	6DCT	F	R	Estate FWD BKD/CFFB/CLJA		2540110L	Drive Shaft		36		59.5	40.5	760
	2009.10-2015.05	6MT	F	R	Estate FWD BKD/CFFB/CLJA		2033130L	Drive Shaft		36		59.5	40.5	794
	2009.10-2015.05	6MT	F	R	Estate FWD BKD/CFFB/CLJA		2611470L	Drive Shaft		36		59.5	40.5	795
	2009.10-2015.05	MT/6MT	F	L	Estate FWD BKD/CFFB/CLJA		2033800L	Drive Shaft		36		59.5	40	487
2010.11-2015.05	6DCT	F	L	Estate 4WD CFFB		2033810L	Drive Shaft		36		59.5	40	485	
2010.11-2015.05	6DCT	F	L	Estate 4WD CFFB		2540130L	Drive Shaft		36		59.5	40.5	482	



  YEAR	TRANSM.	F/R	L/R	BODY STYLE & DRIVE TYPE & ENGINE	REMARKS	GSP Ref.	 PRODUCT	 ABS	Technical Specifications				
									A	B	C	H	L
SKODA Superb													
2.0 (103 kw)													
2010.11-2015.05	6MT	F	L	Estate 4WD CFFB		2032950L	Drive Shaft		36	59.5	40.5	486	
2010.11-2015.05	6MT	F	R	Estate 4WD CFFB		2032660L	Drive Shaft		36	59.5	40.5	601	
2010.11-2015.05	6DCT	F	L	Hatchback 4WD CFFB		2033810L	Drive Shaft		36	59.5	40	485	
2010.11-2015.05	6DCT	F	L	Hatchback 4WD CFFB		2540130L	Drive Shaft		36	59.5	40.5	482	
2010.11-2015.05	6MT	F	L	Hatchback 4WD CFFB		2032950L	Drive Shaft		36	59.5	40.5	486	
2010.11-2015.05	6MT	F	R	Hatchback 4WD CFFB		2032660L	Drive Shaft		36	59.5	40.5	601	
2.0 (110 kw)													
2015.03-	6AT	F	L	Estate 4WD CRLB/DFEA/DFGA		2033810L	Drive Shaft		36	59.5	40	485	
2015.03-	6MT	F	L	Estate 4WD CRLB/DFEA/DFGA		2018960L	Drive Shaft		36	59.5	40	500	
2015.03-	6MT	F	R	Estate 4WD CRLB/DFEA/DFGA		2018890L	Drive Shaft		36	59.5	40	614	
2015.03-	6DCT	F	L	Estate FWD CRLB/DFGA/DSRA/DSRB/DTS/ADT/BS		2033810L	Drive Shaft		36	59.5	40	485	
2015.03-	6DCT	F	R	Estate FWD CRLB/DFGA/DSRA/DSRB/DTS/ADT/BS		2613450L	Drive Shaft		36	59.5	40	774	
2015.03-	6MT	F	L	Estate FWD CRLB/DFGA/DSRA/DSRB/DTS/ADT/BS		2611000L	Drive Shaft		36	59.5	40.5	514	
2015.03-	6MT	F	R	Estate FWD CRLB/DFGA/DSRA/DSRB/DTS/ADT/BS		2613410L	Drive Shaft		36	59.5	40.5	806	
2015.03-	7DCT	F	L	Estate FWD CRLB/DFGA/DSRA/DSRB/DTS/ADT/BS		2023510L	Drive Shaft		36	37	59.5	40	570
2015.03-	7DCT	F	R	Estate FWD CRLB/DFGA/DSRA/DSRB/DTS/ADT/BS		2036130L	Drive Shaft		36	37	59.5	40	921
2015.03-	6AT	F	L	Hatchback 4WD CRLB/DFEA/DFGA		2033810L	Drive Shaft		36	59.5	40	485	
2015.03-	6MT	F	L	Hatchback 4WD CRLB/DFEA/DFGA		2018960L	Drive Shaft		36	59.5	40	500	
2015.03-	6MT	F	R	Hatchback 4WD CRLB/DFEA/DFGA		2018890L	Drive Shaft		36	59.5	40	614	
2015.03-	6DCT	F	L	Hatchback FWD CRLB/DFGA/DSRA/DSRB/DTS/ADT/BS		2033810L	Drive Shaft		36	59.5	40	485	
2015.03-	6DCT	F	R	Hatchback FWD CRLB/DFGA/DSRA/DSRB/DTS/ADT/BS		2613450L	Drive Shaft		36	59.5	40	774	
2015.03-	6MT	F	L	Hatchback FWD CRLB/DFGA/DSRA/DSRB/DTS/ADT/BS		2611000L	Drive Shaft		36	59.5	40.5	514	
2015.03-	6MT	F	R	Hatchback FWD CRLB/DFGA/DSRA/DSRB/DTS/ADT/BS		2613410L	Drive Shaft		36	59.5	40.5	806	
2015.03-	7DCT	F	L	Hatchback FWD CRLB/DFGA/DSRA/DSRB/DTS/ADT/BS		2023510L	Drive Shaft		36	37	59.5	40	570
2015.03-	7DCT	F	R	Hatchback FWD CRLB/DFGA/DSRA/DSRB/DTS/ADT/BS		2036130L	Drive Shaft		36	37	59.5	40	921
2.0 (125 kw)													
2008.06-2015.05	6DCT	F	L	Hatchback FWD CBBB/CFGB	Rims:With alloy rim	2033810L	Drive Shaft		36	59.5	40	485	
2008.06-2015.05	6DCT	F	L	Hatchback FWD CBBB/CFGB	Rims:With steel rim	2540130L	Drive Shaft		36	59.5	40.5	482	
2008.06-2015.05	6DCT	F	R	Hatchback FWD CBBB/CFGB		2540110L	Drive Shaft		36	59.5	40.5	760	
2008.06-2015.05	6MT	F	L	Hatchback FWD CBBB/CFGB		2032950L	Drive Shaft		36	59.5	40.5	486	
2008.06-2015.05	6MT	F	R	Hatchback FWD CBBB/CFGB		2033130L	Drive Shaft		36	59.5	40.5	794	
2008.06-2015.05	6MT	F	R	Hatchback FWD CBBB/CFGB		2611470L	Drive Shaft		36	59.5	40.5	795	
2008.06-2015.05	MT	F	L	Hatchback FWD CBBB/CFGB		2033800L	Drive Shaft		36	59.5	40	487	
2008.09-2015.05	6DCT	F	L	Hatchback 4WD CBBB/CFGB		2033810L	Drive Shaft		36	59.5	40	485	
2008.09-2015.05	6DCT	F	L	Hatchback 4WD CBBB/CFGB		2540130L	Drive Shaft		36	59.5	40.5	482	
2008.09-2015.05	6MT	F	L	Hatchback 4WD CBBB/CFGB		2032950L	Drive Shaft		36	59.5	40.5	486	
2008.09-2015.05	6MT	F	R	Hatchback 4WD CBBB/CFGB		2032660L	Drive Shaft		36	59.5	40.5	601	
2008.09-2015.05	MT	F	L	Hatchback 4WD CBBB/CFGB		2033800L	Drive Shaft		36	59.5	40	487	
2009.10-2015.05	6DCT	F	L	Estate 4WD CBBB/CFGB		2033810L	Drive Shaft		36	59.5	40	485	
2009.10-2015.05	6DCT	F	L	Estate 4WD CBBB/CFGB		2540130L	Drive Shaft		36	59.5	40.5	482	
2009.10-2015.05	6MT	F	L	Estate 4WD CBBB/CFGB		2032950L	Drive Shaft		36	59.5	40.5	486	
2009.10-2015.05	6MT	F	R	Estate 4WD CBBB/CFGB		2032660L	Drive Shaft		36	59.5	40.5	601	
2009.10-2015.05	MT	F	L	Estate 4WD CBBB/CFGB		2033800L	Drive Shaft		36	59.5	40	487	
2009.10-2015.05	6DCT	F	L	Estate FWD CBBB/CFGB	Rims:With alloy rim	2033810L	Drive Shaft		36	59.5	40	485	
2009.10-2015.05	6DCT	F	L	Estate FWD CBBB/CFGB	Rims:With steel rim	2540130L	Drive Shaft		36	59.5	40.5	482	
2009.10-2015.05	6DCT	F	R	Estate FWD CBBB/CFGB		2540110L	Drive Shaft		36	59.5	40.5	760	
2009.10-2015.05	6MT	F	L	Estate FWD CBBB/CFGB		2032950L	Drive Shaft		36	59.5	40.5	486	
2009.10-2015.05	6MT	F	R	Estate FWD CBBB/CFGB		2033130L	Drive Shaft		36	59.5	40.5	794	
2009.10-2015.05	6MT	F	R	Estate FWD CBBB/CFGB		2611470L	Drive Shaft		36	59.5	40.5	795	
2009.10-2015.05	MT	F	L	Estate FWD CBBB/CFGB		2033800L	Drive Shaft		36	59.5	40	487	
2.0 (140 kw)													
2015.03-	6DCT	F	L	Estate 4WD DDAA/DFCA/DFHA	For PR code:1PA/1PE	2033810L	Drive Shaft		36	59.5	40	485	
2015.03-	7DCT	F	L	Estate 4WD DDAA/DFCA/DFHA		2023510L	Drive Shaft		36	37	59.5	40	570
2015.03-	6DCT	F	L	Estate FWD DDAA/DFCA/DFHA	For PR code:1PA/1PE	2033810L	Drive Shaft		36	59.5	40	485	
2015.03-	6DCT	F	R	Estate FWD DDAA/DFCA/DFHA		2613450L	Drive Shaft		36	59.5	40	774	
2015.03-	6MT	F	L	Estate FWD DDAA/DFCA/DFHA		2611000L	Drive Shaft		36	59.5	40.5	514	
2015.03-	6MT	F	R	Estate FWD DDAA/DFCA/DFHA		2613410L	Drive Shaft		36	59.5	40.5	806	
2015.03-	7DCT	F	L	Estate FWD DDAA/DFCA/DFHA		2023510L	Drive Shaft		36	37	59.5	40	570
2015.03-	7DCT	F	R	Estate FWD DDAA/DFCA/DFHA		2036130L	Drive Shaft		36	37	59.5	40	921
2015.03-	6DCT	F	L	Hatchback FWD DDAA/DFCA		2033810L	Drive Shaft		36	59.5	40	485	
2015.03-	6DCT	F	R	Hatchback FWD DDAA/DFCA		2613450L	Drive Shaft		36	59.5	40	774	
2015.03-	6MT	F	L	Hatchback FWD DDAA/DFCA		2611000L	Drive Shaft		36	59.5	40.5	514	
2015.03-	6MT	F	R	Hatchback FWD DDAA/DFCA		2613410L	Drive Shaft		36	59.5	40.5	806	
2015.08-	6AT/7AT	F	L	Hatchback 4WD DDAA/DFCA		2033810L	Drive Shaft		36	59.5	40	485	
2.0 (147 kw)													
2010.05-2015.05	6AT	F	R	Estate FWD CCZA		2016530L	Drive Shaft		36	59.5	40.5	785	
2010.05-2015.05	AT	F	L	Estate FWD CCZA		2033800L	Drive Shaft		36	59.5	40	487	
2010.05-2015.05	6AT	F	R	Hatchback FWD CCZA		2016530L	Drive Shaft		36	59.5	40.5	785	
2010.05-2015.05	AT	F	L	Hatchback FWD CCZA		2033800L	Drive Shaft		36	59.5	40	487	



		TRANSM.	F/R	L/R	BODY STYLE & DRIVE TYPE & ENGINE	REMARKS	GSP Ref.		PRODUCT ABS	Technical Specifications				
										A	B	C	H	L
SKODA Superb														
2.0 (147 kw)	2020.09-	7DCT	F	R	Estate FWD DTUA		2036130L	Drive Shaft		36	37	59.5	40	921
	2020.09-	7DCT	F	R	Hatchback FWD DTUA		2036130L	Drive Shaft		36	37	59.5	40	921
2.0 (200 kw)	2015.03-	7AT	F	R	Estate 4WD DNUA		2018890L	Drive Shaft		36		59.5	40	614
	2015.03-	7AT	F	R	Hatchback 4WD DNUA		2018890L	Drive Shaft		36		59.5	40	614
2.0 (206 kw)	2015.03-	6AT	F	R	Estate 4WD CJXA/DNFE		2018890L	Drive Shaft		36		59.5	40	614
	2015.03-	6AT	F	R	Hatchback 4WD CJXA/DNFE		2018890L	Drive Shaft		36		59.5	40	614
3.6 (191 kw)	2008.09-2015.05	AT	F	L	Hatchback 4WD CDVA		2033800L	Drive Shaft		36		59.5	40	487
	2009.10-2015.05	AT	F	L	Estate 4WD CDVA		2033800L	Drive Shaft		36		59.5	40	487
Yeti														
1.2 (77 kw)	2009.09-2015.05	AT/MT	F	L	SUV FWD CBZB		2612010L	Drive Shaft		36		59.5	40	536
	2009.09-2015.05	AT/MT	F	R	SUV FWD CBZB		2610960L	Drive Shaft		36		59.5	40	800
1.2 (81 kw)	2015.05-2017.12	6MT	F	R	SUV FWD CYVB		2613070L	Drive Shaft		36		59.5	40	820
	2015.05-2017.12	DCT	F	L	SUV FWD CYVB		2612820L	Drive Shaft		36		59.5	40	523
	2015.05-2017.12	DCT	F	R	SUV FWD CYVB		2610960L	Drive Shaft		36		59.5	40	800
1.4 (90 kw)	2010.06-2015.05	7AT/6MT	F	L	SUV FWD CAXA		2612010L	Drive Shaft		36		59.5	40	536
	2010.06-2015.05	7AT/6MT	F	R	SUV FWD CAXA		2610960L	Drive Shaft		36		59.5	40	800
1.4 (92 kw)	2015.05-2017.12	6MT	F	R	SUV FWD CZCA		2613410L	Drive Shaft		36		59.5	40.5	806
	2015.05-2017.12	6MT/7DCT	F	L	SUV FWD CZCA		2611000L	Drive Shaft		36		59.5	40.5	514
	2015.05-2017.12	7DCT	F	R	SUV FWD CZCA		2033130L	Drive Shaft		36		59.5	40.5	794
1.4 (110 kw)	2015.05-2017.12	6MT/6DCT	F	L	SUV 4WD CZDA		2032950L	Drive Shaft		36		59.5	40.5	486
	2015.05-2017.12	6MT/6DCT	F	R	SUV 4WD CZDA		2032660L	Drive Shaft		36		59.5	40.5	601
1.6 (77 kw)	2010.11-2015.05	7AT/5MT	F	L	SUV FWD CAYC		2032940L	Drive Shaft		36		59.5	40	517
	2010.11-2015.05	7AT/5MT	F	R	SUV FWD CAYC		2610420L	Drive Shaft		36		59.5	40	814
	2010.11-2015.05	7DCT	F	L	SUV FWD CAYC		2611000L	Drive Shaft		36		59.5	40.5	514
	2010.11-2015.05	7DCT	F	R	SUV FWD CAYC		2033130L	Drive Shaft		36		59.5	40.5	794
1.6 (81 kw)	2014.04-2017.12	6AT	F	R	SUV FWD CWVA		2610940L	Drive Shaft		36	26	59.5	40	884
	2014.04-2017.12	MT	F	L	SUV FWD CWVA		2612820L	Drive Shaft		36		59.5	40	523
	2014.04-2017.12	MT	F	R	SUV FWD CWVA		2613070L	Drive Shaft		36		59.5	40	820
1.8 (112 kw)	2009.11-2017.12	6AT/6MT	F	L	SUV 4WD CDAB		2032950L	Drive Shaft		36		59.5	40.5	486
	2009.11-2017.12	6AT/6MT	F	R	SUV 4WD CDAB		2032660L	Drive Shaft		36		59.5	40.5	601
1.8 (118 kw)	2009.05-2017.12	6MT	F	L	SUV 4WD CDA A		2032950L	Drive Shaft		36		59.5	40.5	486
	2009.05-2017.12	6MT	F	R	SUV 4WD CDA A		2032660L	Drive Shaft		36		59.5	40.5	601
	2009.05-2017.12		F	L	SUV 4WD CDA A		2033800L	Drive Shaft		36		59.5	40	487
2.0 (81 kw)	2009.11-2017.12	MT	F	L	SUV 4WD CFHF/CUUA/DFSA		2032950L	Drive Shaft		36		59.5	40.5	486
	2009.11-2017.12	MT	F	L	SUV 4WD CFHF/CUUA/DFSA		2033800L	Drive Shaft		36		59.5	40	487
	2009.11-2017.12	MT	F	R	SUV 4WD CFHF/CUUA/DFSA		2032660L	Drive Shaft		36		59.5	40.5	601
	2009.11-2017.12	5MT	F	L	SUV FWD CFHA/CLCA/CUUA/DFSA		2611000L	Drive Shaft		36		59.5	40.5	514
	2009.11-2017.12	5MT	F	L	SUV FWD CFHA/CLCA/CUUA/DFSA		2612820L	Drive Shaft		36		59.5	40	523
	2009.11-2017.12	5MT	F	R	SUV FWD CFHA/CLCA/CUUA/DFSA		2612830L	Drive Shaft		36		59.5	40	815
	2009.11-2017.12	5MT	F	R	SUV FWD CFHA/CLCA/CUUA/DFSA		2613410L	Drive Shaft		36		59.5	40.5	806
	2009.11-2017.12		F	L	SUV FWD CFHA/CLCA/CUUA/DFSA		2032940L	Drive Shaft		36		59.5	40	517
2.0 (103 kw)	2009.05-2017.12	6DCT	F	L	SUV 4WD CBDB/CFHC/CLCB	PR code:1PA	2033800L	Drive Shaft		36		59.5	40	487
	2009.05-2017.12	6MT	F	L	SUV 4WD CBDB/CFHC/CLCB		2032950L	Drive Shaft		36		59.5	40.5	486
	2009.05-2017.12	6MT/6DCT	F	R	SUV 4WD CBDB/CFHC/CLCB		2032660L	Drive Shaft		36		59.5	40.5	601
	2009.05-2017.12		F	L	SUV 4WD CBDB/CFHC/CLCB		2033800L	Drive Shaft		36		59.5	40	487
	2010.05-2017.12	6MT	F	L	SUV FWD CFHC/CLCB		2032950L	Drive Shaft		36		59.5	40.5	486
	2010.05-2017.12	6MT	F	R	SUV FWD CFHC/CLCB		2611470L	Drive Shaft		36		59.5	40.5	795
	2010.05-2017.12	MT	F	L	SUV FWD CFHC/CLCB		2033800L	Drive Shaft		36		59.5	40	487
2.0 (110 kw)	2010.05-2017.12		F	R	SUV FWD CFHC/CLCB		2033130L	Drive Shaft		36		59.5	40.5	794
	2015.05-2017.12	6DCT	F	L	SUV 4WD CUUB/DFSB		2032950L	Drive Shaft		36		59.5	40.5	486
	2015.05-2017.12	6MT	F	R	SUV FWD CUUB/DFSB		2611470L	Drive Shaft		36		59.5	40.5	795
	2015.05-2017.12	MT	F	L	SUV FWD CUUB/DFSB		2032950L	Drive Shaft		36		59.5	40.5	486
	2015.05-2017.12	MT	F	R	SUV FWD CUUB/DFSB		2032660L	Drive Shaft		36		59.5	40.5	601
2.0 (125 kw)	2015.05-2017.12		F	R	SUV FWD CUUB/DFSB		2033130L	Drive Shaft		36		59.5	40.5	794
	2009.11-2015.12	6AT/6MT	F	L	SUV 4WD CEGA/CFJA		2032950L	Drive Shaft		36		59.5	40.5	486
	2009.11-2015.12	6AT/6MT	F	R	SUV 4WD CEGA/CFJA		2032660L	Drive Shaft		36		59.5	40.5	601
	2009.11-2015.12	6DCT	F	L	SUV 4WD CEGA/CFJA	For PR code:1PA	2033800L	Drive Shaft		36		59.5	40	487
2009.11-2015.12		F	L	SUV 4WD CEGA/CFJA		2033800L	Drive Shaft		36		59.5	40	487	
SUZUKI SX4														
1.6 (86 kw)	2014.08-	AT	F	R	Hatchback 4WD M16A		2572880L	Drive Shaft		28	28	58	85	706
	2014.08-	MT	F	L	Hatchback 4WD M16A		2572870L	Drive Shaft		28	26	58	85	647
	2014.08-	MT	F	L	Hatchback FWD M16A		2572870L	Drive Shaft		28	26	58	85	647



  YEAR	TRANSM.	F/R	L/R	BODY STYLE & DRIVE TYPE & ENGINE	REMARKS	GSP Ref.	 PRODUCT	 ABS	Technical Specifications					
									A	B	C	H	L	
SUZUKI														
SX4 S-Cross														
1.6 (86 kw)	2013.12-	AT	F	R	Hatchback 4WD M16A		257288OL	Drive Shaft		28	28	58	85	706
	2013.12-	MT	F	L	Hatchback 4WD M16A		257287OL	Drive Shaft		28	26	58	85	647
	2013.12-	MT	F	L	Hatchback FWD M16A		257287OL	Drive Shaft		28	26	58	85	647
1.6 (88 kw)	2013.08-	AT	F	R	Hatchback 4WD M16A		257288OL	Drive Shaft		28	28	58	85	706
	2013.08-	MT	F	L	Hatchback 4WD M16A		257287OL	Drive Shaft		28	26	58	85	647
	2013.08-	MT	F	L	Hatchback FWD M16A		257287OL	Drive Shaft		28	26	58	85	647
Vitara														
1.6 (86 kw)	2015.05-	5MT	F	L	SUV 4WD M16A		257287OL	Drive Shaft		28	26	58	85	647
	2015.05-	5MT	F	R	SUV 4WD M16A		257288OL	Drive Shaft		28	28	58	85	706
	2015.05-	5MT	F	L	SUV FWD M16A		257287OL	Drive Shaft		28	26	58	85	647
1.6 (88 kw)	2015.02-	5MT	F	L	SUV 4WD M16A		257287OL	Drive Shaft		28	26	58	85	647
	2015.02-	5MT	F	R	SUV 4WD M16A		257288OL	Drive Shaft		28	28	58	85	706
	2015.02-	5MT	F	L	SUV FWD M16A		257287OL	Drive Shaft		28	26	58	85	647
TESLA														
Model 3														
ET (175 kw)	2019.04-	ET	R	L/R	Saloon RWD 3D6		204028OL	Drive Shaft		30	29	52	98	809
ET (192 kw)	2017.08-	ET	R	L/R	Saloon RWD 3DU		204028OL	Drive Shaft		30	29	52	98	809
ET (208 kw)	2020.03-	ET	R	L/R	Saloon RWD 3D5		204028OL	Drive Shaft		30	29	52	98	809
ET (225 kw)	2019.02-	ET	R	L/R	Saloon RWD 3D1		204028OL	Drive Shaft		30	29	52	98	809
ET (239 kw)	2019.12-	ET	R	L/R	Saloon RWD 3D1		204028OL	Drive Shaft		30	29	52	98	809
ET (258 kw)	2018.06-	ET	F	L/R	Saloon 4WD 3DU	Diameter:25mm	204027OL	Drive Shaft		30	29	52	98	805
	2018.06-	ET	R	L/R	Saloon 4WD 3DU		204028OL	Drive Shaft		30	29	52	98	809
ET (324 kw)	2019.03-	ET	R	L/R	Saloon 4WD 3D1/3D3		204028OL	Drive Shaft		30	29	52	98	809
ET (340 kw)	2018.06-	ET	F	L/R	Saloon 4WD 3DU	Diameter:25mm	204027OL	Drive Shaft		30	29	52	98	805
	2018.06-	ET	R	L/R	Saloon 4WD 3DU		204028OL	Drive Shaft		30	29	52	98	809
ET (350 kw)	2019.06-	ET	F	L/R	Saloon 4WD 3D1	Diameter:25mm	204027OL	Drive Shaft		30	29	52	98	805
	2019.06-	ET	R	L/R	Saloon 4WD 3D1		204028OL	Drive Shaft		30	29	52	98	809
ET (355 kw)	2019.02-	ET	F	L/R	Saloon 4WD 3D1	Diameter:25mm	204027OL	Drive Shaft		30	29	52	98	805
	2019.02-	ET	R	L/R	Saloon 4WD 3D1		204028OL	Drive Shaft		30	29	52	98	809
ET (360 kw)	2019.06-	ET	F	L/R	Saloon 4WD 3D1	Diameter:25mm	204027OL	Drive Shaft		30	29	52	98	805
	2019.06-	ET	R	L/R	Saloon 4WD 3D1		204028OL	Drive Shaft		30	29	52	98	809
ET (361 kw)	2019.12-	ET	F	L/R	Saloon 4WD 3D3	Diameter:25mm	204027OL	Drive Shaft		30	29	52	98	805
	2019.12-	ET	R	L/R	Saloon 4WD 3D3		204028OL	Drive Shaft		30	29	52	98	809
ET (366 kw)	2020.12-	ET	F	L/R	Saloon 4WD 3D3	Diameter:25mm	204027OL	Drive Shaft		30	29	52	98	805
	2020.12-	ET	R	L/R	Saloon 4WD 3D3		204028OL	Drive Shaft		30	29	52	98	809
ET (377 kw)	2019.12-	ET	F	L/R	Saloon 4WD 3D3	Diameter:25mm	204027OL	Drive Shaft		30	29	52	98	805
	2019.12-	ET	R	L/R	Saloon 4WD 3D3		204028OL	Drive Shaft		30	29	52	98	809
Model S 100D														
ET (310 kw)	2017.06-	ET	F	L	Hatchback 4WD L2S	Trim Level:1	201698OL	Drive Shaft		30	29	63	120	773
	2017.06-	ET	F	R	Hatchback 4WD L2S	Trim Level:1	201701OL	Drive Shaft		30	27	63	120	715
	2017.06-	ET	R	L/R	Hatchback 4WD L2S		201699OL	Drive Shaft		30	29	63	120	868
ET (386 kw)	2017.06-	ET	F	L	Hatchback 4WD L2S	Trim Level:1	201698OL	Drive Shaft		30	29	63	120	773
	2017.06-	ET	F	R	Hatchback 4WD L2S	Trim Level:1	201701OL	Drive Shaft		30	27	63	120	715
	2017.06-	ET	R	L/R	Hatchback 4WD L2S		201699OL	Drive Shaft		30	29	63	120	868
Model S 60														
ET (225 kw)	2013.11-2014.09	ET	R	L/R	Hatchback RWD L1S		201699OL	Drive Shaft		30	29	63	120	868
ET (235 kw)	2016.11-	ET	R	L/R	Hatchback RWD L1S		201699OL	Drive Shaft		30	29	63	120	868
ET (283 kw)	2014.10-	ET	R	L/R	Hatchback RWD L1S		201699OL	Drive Shaft		30	29	63	120	868
ET (285 kw)	2013.11-	ET	R	L/R	Hatchback RWD L1S		201699OL	Drive Shaft		30	29	63	120	868
Model S 60D														
ET (245 kw)	2016.06-	ET	F	L	Hatchback 4WD L2S	Trim Level:1	201698OL	Drive Shaft		30	29	63	120	773
	2016.06-	ET	F	R	Hatchback 4WD L2S	Trim Level:1	201701OL	Drive Shaft		30	27	63	120	715
	2016.06-	ET	R	L/R	Hatchback 4WD L2S		201699OL	Drive Shaft		30	29	63	120	868
ET (276 kw)	2014.10-2015.04	ET	F	L	Hatchback 4WD L2S		201698OL	Drive Shaft		30	29	63	120	773
	2014.10-2015.04	ET	F	R	Hatchback 4WD L2S		201701OL	Drive Shaft		30	27	63	120	715
	2014.10-2015.04	ET	R	L/R	Hatchback 4WD L2S		201699OL	Drive Shaft		30	29	63	120	868
ET (386 kw)	2014.10-	ET	F	L	Hatchback 4WD L2S		201698OL	Drive Shaft		30	29	63	120	773
	2014.10-	ET	F	R	Hatchback 4WD L2S		201701OL	Drive Shaft		30	27	63	120	715
	2014.10-	ET	R	L/R	Hatchback 4WD L2S		201699OL	Drive Shaft		30	29	63	120	868
Model S 70														
ET (235 kw)	2015.09-	ET	R	L/R	Hatchback RWD L1S		201699OL	Drive Shaft		30	29	63	120	868
ET (285 kw)	2015.09-	ET	R	L/R	Hatchback RWD L1S		201699OL	Drive Shaft		30	29	63	120	868
Model S 70D														
ET (245 kw)	2015.04-	ET	F	L	Hatchback 4WD L2S		201698OL	Drive Shaft		30	29	63	120	773
	2015.04-	ET	F	R	Hatchback 4WD L2S		201701OL	Drive Shaft		30	27	63	120	715





 YEAR	TRANSM.	F/R	L/R	BODY STYLE & DRIVE TYPE & ENGINE	REMARKS	GSP Ref.	 PRODUCT	 ABS	Technical Specifications					
									A	B	C	H	L	
TESLA														
Model S 70D														
ET (245 kw)	2015.04-	ET	R	L/R	Hatchback 4WD L2S		2016990L	Drive Shaft		30	29	63	120	868
ET (386 kw)	2015.09-	ET	F	L	Hatchback 4WD L2S		2016980L	Drive Shaft		30	29	63	120	773
	2015.09-	ET	F	R	Hatchback 4WD L2S		2017010L	Drive Shaft		30	27	63	120	715
	2015.09-	ET	R	L/R	Hatchback 4WD L2S		2016990L	Drive Shaft		30	29	63	120	868
Model S 75														
ET (235 kw)	2016.11-	ET	R	L/R	Hatchback RWD L1S		2016990L	Drive Shaft		30	29	63	120	868
ET (285 kw)	2016.11-	ET	R	L/R	Hatchback RWD L1S		2016990L	Drive Shaft		30	29	63	120	868
Model S 75D														
ET (245 kw)	2016.06-	ET	F	L	Hatchback 4WD L2S	Trim Level:1	2016980L	Drive Shaft		30	29	63	120	773
	2016.06-	ET	F	R	Hatchback 4WD L2S	Trim Level:1	2017010L	Drive Shaft		30	27	63	120	715
	2016.06-	ET	R	L/R	Hatchback 4WD L2S		2016990L	Drive Shaft		30	29	63	120	868
ET (386 kw)	2016.06-	ET	F	L	Hatchback 4WD L2S	Trim Level:1	2016980L	Drive Shaft		30	29	63	120	773
	2016.06-	ET	F	R	Hatchback 4WD L2S	Trim Level:1	2017010L	Drive Shaft		30	27	63	120	715
	2016.06-	ET	R	L/R	Hatchback 4WD L2S		2016990L	Drive Shaft		30	29	63	120	868
Model S 85														
ET (270 kw)	2012.09-2016.02	ET	R	L/R	Hatchback RWD L1S		2016990L	Drive Shaft		30	29	63	120	868
ET (283 kw)	2015.02-2016.02	ET	R	L/R	Hatchback RWD L1S		2016990L	Drive Shaft		30	29	63	120	868
ET (285 kw)	2012.09-2016.02	ET	R	L/R	Hatchback RWD L1S		2016990L	Drive Shaft		30	29	63	120	868
Model S 85D														
ET (276 kw)	2014.10-2016.02	ET	F	L	Hatchback 4WD L2S		2016980L	Drive Shaft		30	29	63	120	773
	2014.10-2016.02	ET	F	R	Hatchback 4WD L2S		2017010L	Drive Shaft		30	27	63	120	715
	2014.10-2016.02	ET	R	L/R	Hatchback 4WD L2S		2016990L	Drive Shaft		30	29	63	120	868
ET (279 kw)	2014.10-2016.02	ET	F	L	Hatchback 4WD L2S		2016980L	Drive Shaft		30	29	63	120	773
	2014.10-2016.02	ET	F	R	Hatchback 4WD L2S		2017010L	Drive Shaft		30	27	63	120	715
	2014.10-2016.02	ET	R	L/R	Hatchback 4WD L2S		2016990L	Drive Shaft		30	29	63	120	868
ET (290 kw)	2014.10-2015.07	ET	F	L	Hatchback 4WD L2S		2016980L	Drive Shaft		30	29	63	120	773
	2014.10-2015.07	ET	F	R	Hatchback 4WD L2S		2017010L	Drive Shaft		30	27	63	120	715
	2014.10-2015.07	ET	R	L/R	Hatchback 4WD L2S		2016990L	Drive Shaft		30	29	63	120	868
ET (310 kw)	2015.04-2016.02	ET	F	L	Hatchback 4WD L2S		2016980L	Drive Shaft		30	29	63	120	773
	2015.04-2016.02	ET	F	R	Hatchback 4WD L2S		2017010L	Drive Shaft		30	27	63	120	715
	2015.04-2016.02	ET	R	L/R	Hatchback 4WD L2S		2016990L	Drive Shaft		30	29	63	120	868
ET (386 kw)	2014.10-2016.02	ET	F	L	Hatchback 4WD L2S		2016980L	Drive Shaft		30	29	63	120	773
	2014.10-2016.02	ET	F	R	Hatchback 4WD L2S		2017010L	Drive Shaft		30	27	63	120	715
	2014.10-2016.02	ET	R	L/R	Hatchback 4WD L2S		2016990L	Drive Shaft		30	29	63	120	868
Model S 90D														
ET (310 kw)	2015.09-	ET	F	L	Hatchback 4WD L2S		2016980L	Drive Shaft		30	29	63	120	773
	2015.09-	ET	F	R	Hatchback 4WD L2S		2017010L	Drive Shaft		30	27	63	120	715
	2015.09-	ET	R	L/R	Hatchback 4WD L2S		2016990L	Drive Shaft		30	29	63	120	868
ET (386 kw)	2015.09-	ET	F	L	Hatchback 4WD L2S		2016980L	Drive Shaft		30	29	63	120	773
	2015.09-	ET	F	R	Hatchback 4WD L2S		2017010L	Drive Shaft		30	27	63	120	715
	2015.09-	ET	R	L/R	Hatchback 4WD L2S		2016990L	Drive Shaft		30	29	63	120	868
Model S P100D														
ET (450 kw)	2016.10-	ET	F	L	Hatchback 4WD L2S	Trim Level:1	2016980L	Drive Shaft		30	29	63	120	773
	2016.10-	ET	F	R	Hatchback 4WD L2S	Trim Level:1	2017010L	Drive Shaft		30	27	63	120	715
	2016.10-	ET	R	L/R	Hatchback 4WD L2S		2016990L	Drive Shaft		30	29	63	120	868
ET (568 kw)	2016.10-	ET	F	L	Hatchback 4WD L2S	Trim Level:1	2016980L	Drive Shaft		30	29	63	120	773
	2016.10-	ET	F	R	Hatchback 4WD L2S	Trim Level:1	2017010L	Drive Shaft		30	27	63	120	715
	2016.10-	ET	R	L/R	Hatchback 4WD L2S		2016990L	Drive Shaft		30	29	63	120	868
Model S P85														
ET (310 kw)	2013.11-2014.12	ET	R	L/R	Hatchback RWD L1S		2016990L	Drive Shaft		30	29	63	120	868
ET (350 kw)	2013.05-2014.12	ET	R	L/R	Hatchback RWD L1S		2016990L	Drive Shaft		30	29	63	120	868
Model S P85D														
ET (515 kw)	2014.10-2016.02	ET	F	L	Hatchback 4WD L2S		2016980L	Drive Shaft		30	29	63	120	773
	2014.10-2016.02	ET	F	R	Hatchback 4WD L2S		2017010L	Drive Shaft		30	27	63	120	715
	2014.10-2016.02	ET	R	L/R	Hatchback 4WD L2S		2016990L	Drive Shaft		30	29	63	120	868
ET (543 kw)	2014.10-2015.10	ET	F	L	Hatchback 4WD L2S		2016980L	Drive Shaft		30	29	63	120	773
	2014.10-2015.10	ET	F	R	Hatchback 4WD L2S		2017010L	Drive Shaft		30	27	63	120	715
	2014.10-2015.10	ET	R	L/R	Hatchback 4WD L2S		2016990L	Drive Shaft		30	29	63	120	868
ET (568 kw)	2015.09-2016.02	ET	F	L	Hatchback 4WD L2S		2016980L	Drive Shaft		30	29	63	120	773
	2015.09-2016.02	ET	F	R	Hatchback 4WD L2S		2017010L	Drive Shaft		30	27	63	120	715
	2015.09-2016.02	ET	R	L/R	Hatchback 4WD L2S		2016990L	Drive Shaft		30	29	63	120	868
Model S P90D														
ET (346 kw)	2015.09-	ET	F	L	Hatchback 4WD L2S		2016980L	Drive Shaft		30	29	63	120	773
	2015.09-	ET	F	R	Hatchback 4WD L2S		2017010L	Drive Shaft		30	27	63	120	715
	2015.09-	ET	R	L/R	Hatchback 4WD L2S		2016990L	Drive Shaft		30	29	63	120	868





		TRANSM.	F/R	L/R	BODY STYLE & DRIVE TYPE & ENGINE	REMARKS	GSP Ref.		ABS	Technical Specifications				
										A	B	C	H	L
TESLA														
Model S P90D														
ET (397 kw)	2015.09-	ET	F	L	Hatchback 4WD L2S		2016980L	Drive Shaft		30	29	63	120	773
	2015.09-	ET	F	R	Hatchback 4WD L2S		2017010L	Drive Shaft		30	27	63	120	715
	2015.09-	ET	R	L/R	Hatchback 4WD L2S		2016990L	Drive Shaft		30	29	63	120	868
ET (568 kw)	2015.09-	ET	F	L	Hatchback 4WD L2S		2016980L	Drive Shaft		30	29	63	120	773
	2015.09-	ET	F	R	Hatchback 4WD L2S		2017010L	Drive Shaft		30	27	63	120	715
	2015.09-	ET	R	L/R	Hatchback 4WD L2S		2016990L	Drive Shaft		30	29	63	120	868
Model X														
ET (386 kw)	2019.06-	ET	R	L/R	Hatchback 4WD L2S		2016990L	Drive Shaft		30	29	63	120	868
ET (413 kw)	2019.06-	ET	R	L/R	Hatchback 4WD 3D1		2016990L	Drive Shaft		30	29	63	120	868
ET (421 kw)	2020.09-	ET	R	L/R	Hatchback 4WD 3D1		2016990L	Drive Shaft		30	29	63	120	868
ET (568 kw)	2019.06-	ET	R	L/R	Hatchback 4WD L2S		2016990L	Drive Shaft		30	29	63	120	868
ET (585 kw)	2019.06-	ET	R	L/R	Hatchback 4WD 3D1		2016990L	Drive Shaft		30	29	63	120	868
ET (599 kw)	2020.09-	ET	R	L/R	Hatchback 4WD 3D1		2016990L	Drive Shaft		30	29	63	120	868
Model X 100D														
ET (386 kw)	2017.08-	ET	F	L	Hatchback 4WD L2S		2017000L	Drive Shaft		30	29	63	120	793
	2017.08-	ET	F	R	Hatchback 4WD L2S		2017020L	Drive Shaft		30	27	63	120	735
	2017.08-	ET	R	L/R	Hatchback 4WD L2S		2016990L	Drive Shaft		30	29	63	120	868
Model X 60D														
ET (386 kw)	2016.06-	ET	F	L	Hatchback 4WD L2S		2017000L	Drive Shaft		30	29	63	120	793
	2016.06-	ET	F	R	Hatchback 4WD L2S		2017020L	Drive Shaft		30	27	63	120	735
	2016.06-	ET	R	L/R	Hatchback 4WD L2S		2016990L	Drive Shaft		30	29	63	120	868
Model X 75D														
ET (386 kw)	2016.06-	ET	F	L	Hatchback 4WD L2S		2017000L	Drive Shaft		30	29	63	120	793
	2016.06-	ET	F	R	Hatchback 4WD L2S		2017020L	Drive Shaft		30	27	63	120	735
	2016.06-	ET	R	L/R	Hatchback 4WD L2S		2016990L	Drive Shaft		30	29	63	120	868
Model X 90D														
ET (386 kw)	2015.09-	ET	F	L	Hatchback 4WD L2S		2017000L	Drive Shaft		30	29	63	120	793
	2015.09-	ET	F	R	Hatchback 4WD L2S		2017020L	Drive Shaft		30	27	63	120	735
	2015.09-	ET	R	L/R	Hatchback 4WD L2S		2016990L	Drive Shaft		30	29	63	120	868
Model X P100D														
ET (568 kw)	2016.10-	ET	F	L	Hatchback 4WD L2S		2017000L	Drive Shaft		30	29	63	120	793
	2016.10-	ET	F	R	Hatchback 4WD L2S		2017020L	Drive Shaft		30	27	63	120	735
	2016.10-	ET	R	L/R	Hatchback 4WD L2S		2016990L	Drive Shaft		30	29	63	120	868
Model X P90D														
ET (568 kw)	2015.09-	ET	F	L	Hatchback 4WD L2S		2017000L	Drive Shaft		30	29	63	120	793
	2015.09-	ET	F	R	Hatchback 4WD L2S		2017020L	Drive Shaft		30	27	63	120	735
	2015.09-	ET	R	L/R	Hatchback 4WD L2S		2016990L	Drive Shaft		30	29	63	120	868
TOYOTA														
Aurion														
3.5 (200 kw)	2006.03-2011.09	6AT	F	L	Saloon FWD 2GRFE		2593240L	Drive Shaft	48T	30	24		100	659
	2006.03-2011.09	6AT	F	R	Saloon FWD 2GRFE		2593230L	Drive Shaft	48T	30	24		100	978
	2011.09-	6AT	F	L	Saloon FWD 2GRFE	Veh Prd Country:Japan	2593240L	Drive Shaft	48T	30	24		100	659
	2011.09-	6AT	F	R	Saloon FWD 2GRFE	Veh Prd Country:Japan/USA	2593230L	Drive Shaft	48T	30	24		100	978
Avalon														
3.5 (200 kw)	2012.11-2018.03	6AT	F	L	Saloon FWD 2GRFE		2593240L	Drive Shaft	48T	30	24		100	659
	2012.11-2018.03	6AT	F	R	Saloon FWD 2GRFE		2593230L	Drive Shaft	48T	30	24		100	978
Camry														
3.5 (183 kw)	2012.12-	6AT	F	L	Saloon FWD 2GRFE	Veh Prd Country:Japan	2593240L	Drive Shaft	48T	30	24		100	659
	2012.12-	6AT	F	R	Saloon FWD 2GRFE	Veh Prd Country:Japan/USA	2593230L	Drive Shaft	48T	30	24		100	978
3.5 (200 kw)	2006.01-2011.12	6AT	F	L	Saloon FWD 2GRFE		2593240L	Drive Shaft	48T	30	24		100	659
	2006.01-2011.12	6AT	F	R	Saloon FWD 2GRFE		2593230L	Drive Shaft	48T	30	24		100	978
3.5 (204 kw)	2006.09-2014.12	6AT	F	L	Saloon FWD 2GRFE		2593240L	Drive Shaft	48T	30	24		100	659
	2006.09-2014.12	6AT	F	R	Saloon FWD 2GRFE		2593230L	Drive Shaft	48T	30	24		100	978
	2011.09-2017.12	6AT	F	L	Saloon FWD 2GRFE	Veh Prd Country:Japan	2593240L	Drive Shaft	48T	30	24		100	659
	2011.09-2017.12	6AT	F	R	Saloon FWD 2GRFE	Veh Prd Country:Japan/USA	2593230L	Drive Shaft	48T	30	24		100	978
FJ Cruiser														
4.0 (176 kw)	2005.06-2009.12	AT/MT	F	L/R	SUV 4WD 1GRFE		2590150L	Drive Shaft		30	30	70	101.5	648
	2005.06-2009.12	5AT	R	L/R	SUV RWD 1GRFE		2590150L	Drive Shaft		30	30	70	101.5	648
4.0 (178 kw)	2006.01-2018.01	5AT/6MT	F	L/R	SUV 4WD 1GRFE	Date To:2009.07	2590150L	Drive Shaft		30	30	70	101.5	648
4.0 (191 kw)	2010.01-2014.06	AT/MT	F	L/R	SUV 4WD 1GRFE		2590150L	Drive Shaft		30	30	70	101.5	648
	2010.01-2014.06	5AT	R	L/R	SUV RWD 1GRFE		2590150L	Drive Shaft		30	30	70	101.5	648
4.0 (200 kw)	2010.12-2018.01		F	L/R	SUV 4WD 1GRFE		2590150L	Drive Shaft		30	30	70	101.5	648
4.0 (203 kw)	2005.06-2018.01	5AT	F	L/R	SUV 4WD 1GRFE		2590150L	Drive Shaft		30	30	70	101.5	648





		TRANSM.	F/R	L/R	BODY STYLE & DRIVE TYPE & ENGINE	REMARKS	GSP Ref.		ABS	Technical Specifications				
										A	B	C	H	L
TOYOTA														
Fortuner														
2.7 (122 kw)	2015.05-	6AT/5MT	F	L/R	SUV 4WD 2TRFE		2597150L	Drive Shaft		30	30	70	101.5	633
2.8 (130 kw)	2015.05-	6AT/6MT	F	L/R	SUV 4WD 1GDFTV		2597150L	Drive Shaft		30	30	70	101.5	633
Hilux														
2.4 (110 kw)	2015.05-	6MT	F	L/R	Pick up 4WD 2GDFTV		2597150L	Drive Shaft		30	30	70	101.5	633
2.4 (125 kw)	2018.10-	6AT/6MT	F	L/R	Pick up 4WD 2GDFTV		2597150L	Drive Shaft		30	30	70	101.5	633
2.8 (130 kw)	2015.05-	AT	F	L/R	Pick up 4WD 1GDFTV		2597150L	Drive Shaft		30	30	70	101.5	633
Land Cruiser														
2.8 (130 kw)	2015.06-	AT/MT	F	L/R	Terrain cab wagon closed 4WD 1GDFTV		2590150L	Drive Shaft		30	30	70	101.5	648
2.8 (147 kw)	2018.10-	AT/MT	F	L/R	Terrain cab wagon closed 4WD 1GDFTV		2590150L	Drive Shaft		30	30	70	101.5	648
3.0 (127 kw)	2009.11-	5AT/6MT	F	L/R	Terrain cab wagon closed 4WD 1KDFTV		2590150L	Drive Shaft		30	30	70	101.5	648
3.0 (140 kw)	2009.08-	AT/MT	F	L/R	Terrain cab wagon closed 4WD 1KDFTV		2590150L	Drive Shaft		30	30	70	101.5	648
4.0 (202 kw)	2010.01-	AT/MT	F	L/R	Terrain cab wagon closed 4WD 1GRFE		2590150L	Drive Shaft		30	30	70	101.5	648
4.0 (205 kw)	2010.01-	AT/MT	F	L/R	Terrain cab wagon closed 4WD 1GRFE		2590150L	Drive Shaft		30	30	70	101.5	648
4.0 (207 kw)	2010.01-	AT/MT	F	L/R	Terrain cab wagon closed 4WD 1GRFE		2590150L	Drive Shaft		30	30	70	101.5	648
Land Cruiser Prado														
2.7 (120 kw)	2003.11-2010.02	4AT	F	L/R	Terrain cab wagon closed 4WD 2TRFE		2590150L	Drive Shaft		30	30	70	101.5	648
2.8 (130 kw)	2015.06-	AT/MT	F	L/R	Terrain cab wagon closed 4WD 1GDFTV		2590150L	Drive Shaft		30	30	70	101.5	648
3.0 (70 kw)	2002.09-2010.02	5MT	F	L/R	Terrain cab wagon closed 4WD 5LE		2590150L	Drive Shaft		30	30	70	101.5	648
3.0 (92 kw)	2002.09-2009.07	AT/MT	F	L/R	Terrain cab wagon closed 4WD 1KZTE		2590150L	Drive Shaft		30	30	70	101.5	648
3.0 (120 kw)	2002.09-2009.08	4AT/5AT/5MT/6MT	F	L/R	Terrain cab wagon closed 4WD 1KDFTV		2590150L	Drive Shaft		30	30	70	101.5	648
3.0 (122 kw)	2004.10-2006.10	5AT/6MT	F	L/R	Terrain cab wagon closed 4WD 1KDFTV		2590150L	Drive Shaft		30	30	70	101.5	648
3.0 (127 kw)	2002.09-2010.12	4AT/5AT/5MT/6MT	F	L/R	Terrain cab wagon closed 4WD 1KDFTV		2590150L	Drive Shaft		30	30	70	101.5	648
	2009.08-	5AT/6MT	F	L/R	Terrain cab wagon closed 4WD 1KDFTV		2590150L	Drive Shaft		30	30	70	101.5	648
3.0 (140 kw)	2009.08-	AT/MT	F	L/R	Terrain cab wagon closed 4WD 1KDFTV		2590150L	Drive Shaft		30	30	70	101.5	648
3.0 (150 kw)	2006.08-2009.07	5AT	F	L/R	Terrain cab wagon closed 4WD 1KDFTV		2590150L	Drive Shaft		30	30	70	101.5	648
3.5 (206 kw)	2015.09-	6AT	F	L/R	Terrain cab wagon closed 4WD 7GRFKS		2590150L	Drive Shaft		30	30	70	101.5	648
4.0 (179 kw)	2002.09-2010.08	4AT/5AT	F	L/R	Terrain cab wagon closed 4WD 1GRFE		2590150L	Drive Shaft		30	30	70	101.5	648
4.0 (183 kw)	2002.12-2010.12	4AT/5AT	F	L/R	Terrain cab wagon closed 4WD 1GRFE		2590150L	Drive Shaft		30	30	70	101.5	648
	2012.11-	5AT/6AT	F	L/R	Terrain cab wagon closed 4WD 1GRFE		2590150L	Drive Shaft		30	30	70	101.5	648
4.0 (207 kw)	2003.01-2009.07	5AT	F	L/R	Terrain cab wagon closed 4WD 1GRFE		2590150L	Drive Shaft		30	30	70	101.5	648
	2010.01-	AT/MT	F	L/R	Terrain cab wagon closed 4WD 1GRFE		2590150L	Drive Shaft		30	30	70	101.5	648
Land Cruiser Van														
3.0 (140 kw)	2011.01-	AT/MT	F	L/R	Terrain cab wagon closed 4WD 1KDFTV		2590150L	Drive Shaft		30	30	70	101.5	648
Rav 4														
2.0 (91 kw)	2012.12-2018.11	MT	F	L	SUV FWD 1ADFTV		2596220L	Drive Shaft		30	24	61.2	100	626
	2013.11-2018.11	MT	F	L	SUV 4WD 1ADFTV		2596220L	Drive Shaft		30	24	61.2	100	626
	2013.11-2018.11	MT	F	R	SUV 4WD 1ADFTV		2595180L	Drive Shaft		30	24	61.2	100	1004
2.2 (98 kw)	2005.11-2010.12	6MT	F	L	SUV 4WD 2ADFTV		2596220L	Drive Shaft		30	24	61.2	100	626
	2005.11-2010.12	6MT	F	R	SUV 4WD 2ADFTV		2595180L	Drive Shaft		30	24	61.2	100	1004
2.2 (100 kw)	2006.02-2012.12	6MT	F	L	SUV 4WD 2ADFTV		2596220L	Drive Shaft		30	24	61.2	100	626
	2006.02-2012.12	6MT	F	R	SUV 4WD 2ADFTV		2595180L	Drive Shaft		30	24	61.2	100	1004
2.2 (110 kw)	2008.12-2013.06	MT	F	L	SUV 4WD 2ADFTV		2596220L	Drive Shaft		30	24	61.2	100	626
	2008.12-2013.06	MT	F	R	SUV 4WD 2ADFTV		2595180L	Drive Shaft		30	24	61.2	100	1004
	2008.12-2013.06	6MT	F	L	SUV FWD 2ADFTV		2596220L	Drive Shaft		30	24	61.2	100	626
	2012.12-	6AT/6MT	F	L	SUV 4WD 2ADFTV	Date From:2015.10	2596220L	Drive Shaft		30	24	61.2	100	626
	2012.12-	6AT/6MT	F	R	SUV 4WD 2ADFTV	Date From:2015.10	2595180L	Drive Shaft		30	24	61.2	100	1004
	2012.12-	6MT	F	L	SUV 4WD 2ADFTV	Date To:2015.09	2596220L	Drive Shaft		30	24	61.2	100	626
	2012.12-	6MT	F	R	SUV 4WD 2ADFTV	Date To:2015.09	2595180L	Drive Shaft		30	24	61.2	100	1004
2.2 (130 kw)	2006.02-2013.06	MT	F	L	SUV 4WD 2ADFHV		2596220L	Drive Shaft		30	24	61.2	100	626
	2006.02-2013.06	MT	F	R	SUV 4WD 2ADFHV		2595180L	Drive Shaft		30	24	61.2	100	1004
	2012.12-	MT	F	L	SUV 4WD 2ADFHV		2596220L	Drive Shaft		30	24	61.2	100	626
	2012.12-	MT	R	R	SUV 4WD 2ADFHV		2595180L	Drive Shaft		30	24	61.2	100	1004
VAUXHALL														
Insignia														
1.6 (125 kw)	2013.03-2017.05	6AT	F	R	Saloon FWD A16XHT/B16SHL		2210450L	Drive Shaft		30	27		94.5	615
	2013.07-2017.05	6AT	F	R	Hatchback FWD A16XHT		2210450L	Drive Shaft		30	27		94.5	615
2.0 (96 kw)	2008.07-2017.05	6AT	F	L	Hatchback FWD A20DT/A20DTJ	Date To:2011.12,Chassis no. to:B1999999	2210450L	Drive Shaft		30	27		94.5	615
	2008.07-2017.05	6AT	F	R	Hatchback FWD A20DT/A20DTJ	Date From:2012.01,Chassis no. from:C1000001,Date To:2011.12,Chassis no. to:B1999999	2210450L	Drive Shaft		30	27		94.5	615
	2008.07-2017.05	6AT	F	L	Saloon FWD A20DT/A20DTJ	Date To:2011.12,Chassis no. to:B1999999	2210450L	Drive Shaft		30	27		94.5	615
	2008.07-2017.05	6AT	F	R	Saloon FWD A20DT/A20DTJ	Date From:2012.01,Chassis no. from:C1000001,Date To:2011.12,Chassis no. to:B1999999	2210450L	Drive Shaft		30	27		94.5	615
2.0 (118 kw)	2008.07-2017.05	6AT	F	L/R	Hatchback 4WD A20DTH	Date To:2011.12,Chassis no. to:B1999999	2210450L	Drive Shaft		30	27		94.5	615
	2008.07-2017.05	6AT	F	L	Hatchback FWD A20DTH	Date To:2011.12,Chassis no. to:B1999999	2210450L	Drive Shaft		30	27		94.5	615
	2008.07-2017.05	6AT	F	R	Hatchback FWD A20DTH	Date From:2012.01,Chassis no. from:C1000001,Date To:2011.12,Chassis no. to:B1999999	2210450L	Drive Shaft		30	27		94.5	615
	2008.07-2017.05	6AT	F	L/R	Saloon 4WD A20DTH	Date To:2011.12,Chassis no. to:B1999999	2210450L	Drive Shaft		30	27		94.5	615
	2008.07-2017.05	6AT	F	L	Saloon FWD A20DTH	Date To:2011.12,Chassis no. to:B1999999	2210450L	Drive Shaft		30	27		94.5	615





		TRANSM.	F/R	L/R	BODY STYLE & DRIVE TYPE & ENGINE	REMARKS	GSP Ref.		PRODUCT ABS	Technical Specifications				
										A	B	C	H	L
VAUXHALL Insignia														
2.0 (118 kw)	2008.07-2017.05	6AT	F	R	Saloon FWD A20DTH	<small>Date From:2012.01 Chassis no. From:C188807 Date To:2011.12 Chassis no. to:B1999999</small>	2210450L	Drive Shaft		30	27		94.5	615
2.0 (120 kw)	2013.07-2017.05	6AT	F	R	Hatchback FWD A20DTH		2210450L	Drive Shaft		30	27		94.5	615
	2013.07-2017.05	6AT	F	R	Saloon FWD A20DTH		2210450L	Drive Shaft		30	27		94.5	615
2.0 (125 kw)	2014.11-2017.05	6AT	F	R	Hatchback FWD B20DTH		2210450L	Drive Shaft		30	27		94.5	615
2.0 (140 kw)	2008.11-2012.02	6AT	F	L	Hatchback FWD A20DTR	<small>Date To:2011.12,Chassis no. to:B1999999</small>	2210450L	Drive Shaft		30	27		94.5	615
	2008.11-2012.02	6AT	F	R	Hatchback FWD A20DTR	<small>Date From:2012.01 Chassis no. From:C188807 Date To:2011.12 Chassis no. to:B1999999</small>	2210450L	Drive Shaft		30	27		94.5	615
	2008.11-2012.02	6AT	F	L	Saloon FWD A20DTR	<small>Date To:2011.12,Chassis no. to:B1999999</small>	2210450L	Drive Shaft		30	27		94.5	615
	2008.11-2012.02	6AT	F	R	Saloon FWD A20DTR	<small>Date From:2012.01 Chassis no. From:C188807 Date To:2011.12 Chassis no. to:B1999999</small>	2210450L	Drive Shaft		30	27		94.5	615
	2009.05-2012.02	6AT	F	L	Hatchback 4WD A20DTR	<small>Date To:2011.12,Chassis no. to:B1999999</small>	2210450L	Drive Shaft		30	27		94.5	615
	2009.05-2012.02	6AT	F	R	Hatchback 4WD A20DTR	<small>Date From:2012.01 Chassis no. From:C188807 Date To:2011.12 Chassis no. to:B1999999</small>	2210450L	Drive Shaft		30	27		94.5	615
	2009.05-2012.02	6AT	F	L	Saloon 4WD A20DTR	<small>Date To:2011.12,Chassis no. to:B1999999</small>	2210450L	Drive Shaft		30	27		94.5	615
	2009.05-2012.02	6AT	F	R	Saloon 4WD A20DTR	<small>Date From:2012.01 Chassis no. From:C188807 Date To:2011.12 Chassis no. to:B1999999</small>	2210450L	Drive Shaft		30	27		94.5	615
	2.0 (143 kw)	2012.03-2017.05	6AT	F	R	Hatchback 4WD A20DTR		2210450L	Drive Shaft		30	27		94.5
2012.03-2017.05		6AT	F	R	Hatchback FWD A20DTR		2210450L	Drive Shaft		30	27		94.5	615
2012.03-2017.05		6AT	F	R	Saloon 4WD A20DTR		2210450L	Drive Shaft		30	27		94.5	615
2012.03-2017.05		6AT	F	R	Saloon FWD A20DTR		2210450L	Drive Shaft		30	27		94.5	615
2.0 (162 kw)	2008.07-2011.06	6AT	F	L/R	Hatchback 4WD A20NHT		2210450L	Drive Shaft		30	27		94.5	615
	2008.07-2011.06	6AT	F	L/R	Saloon 4WD A20NHT		2210450L	Drive Shaft		30	27		94.5	615
	2008.07-2017.05	6AT	F	L/R	Hatchback FWD A20NFT/A20NHT		2210450L	Drive Shaft		30	27		94.5	615
	2008.07-2017.05	6AT	F	L/R	Saloon FWD A20NFT/A20NHT		2210450L	Drive Shaft		30	27		94.5	615
2.8 (191 kw)	2008.07-2017.05	6AT	F	L	Hatchback 4WD A28NET	<small>Date To:2010.12,Chassis no. to:A1999999</small>	2210450L	Drive Shaft		30	27		94.5	615
	2008.07-2017.05	6AT	F	R	Hatchback 4WD A28NET		2210450L	Drive Shaft		30	27		94.5	615
	2008.07-2017.05	6AT	F	L	Saloon 4WD A28NET	<small>Date To:2010.12,Chassis no. to:A1999999</small>	2210450L	Drive Shaft		30	27		94.5	615
	2008.07-2017.05	6AT	F	R	Saloon 4WD A28NET		2210450L	Drive Shaft		30	27		94.5	615
Insignia Country Tourer														
2.0 (120 kw)	2013.07-2017.05	6AT	F	R	Estate FWD A20DTH		2210450L	Drive Shaft		30	27		94.5	615
2.0 (143 kw)	2013.09-2017.05	6AT	F	R	Estate 4WD A20DTR		2210450L	Drive Shaft		30	27		94.5	615
Insignia Sports Tourer														
1.6 (125 kw)	2013.07-2017.05	6AT	F	R	Estate FWD A16XHT		2210450L	Drive Shaft		30	27		94.5	615
2.0 (96 kw)	2008.07-2017.05	6AT	F	L	Estate FWD A20DTI/A20DTJ	<small>Date To:2011.12,Chassis no. to:B1999999</small>	2210450L	Drive Shaft		30	27		94.5	615
	2008.07-2017.05	6AT	F	R	Estate FWD A20DTI/A20DTJ	<small>Date From:2012.01 Chassis no. From:C188807 Date To:2011.12 Chassis no. to:B1999999</small>	2210450L	Drive Shaft		30	27		94.5	615
2.0 (118 kw)	2008.07-2017.05	6AT	F	L/R	Estate 4WD A20DTH	<small>Date To:2011.12,Chassis no. to:B1999999</small>	2210450L	Drive Shaft		30	27		94.5	615
	2008.07-2017.05	6AT	F	L	Estate FWD A20DTH	<small>Date To:2011.12,Chassis no. to:B1999999</small>	2210450L	Drive Shaft		30	27		94.5	615
	2008.07-2017.05	6AT	F	R	Estate FWD A20DTH	<small>Date From:2012.01 Chassis no. From:C188807 Date To:2011.12 Chassis no. to:B1999999</small>	2210450L	Drive Shaft		30	27		94.5	615
2.0 (120 kw)	2013.07-2017.05	6AT	F	R	Estate FWD A20DTH		2210450L	Drive Shaft		30	27		94.5	615
2.0 (125 kw)	2014.11-2017.05	6AT	F	R	Estate FWD B20DTH		2210450L	Drive Shaft		30	27		94.5	615
2.0 (140 kw)	2008.11-2012.02	6AT	F	L	Estate FWD A20DTR	<small>Date To:2011.12,Chassis no. to:B1999999</small>	2210450L	Drive Shaft		30	27		94.5	615
	2008.11-2012.02	6AT	F	R	Estate FWD A20DTR	<small>Date From:2012.01 Chassis no. From:C188807 Date To:2011.12 Chassis no. to:B1999999</small>	2210450L	Drive Shaft		30	27		94.5	615
	2009.05-2012.02	6AT	F	L	Estate 4WD A20DTR	<small>Date To:2011.12,Chassis no. to:B1999999</small>	2210450L	Drive Shaft		30	27		94.5	615
	2009.05-2012.02	6AT	F	R	Estate 4WD A20DTR	<small>Date From:2012.01 Chassis no. From:C188807 Date To:2011.12 Chassis no. to:B1999999</small>	2210450L	Drive Shaft		30	27		94.5	615
2.0 (143 kw)	2012.03-2017.05	6AT	F	R	Estate 4WD A20DTR		2210450L	Drive Shaft		30	27		94.5	615
	2012.03-2017.05	6AT	F	R	Estate FWD A20DTR		2210450L	Drive Shaft		30	27		94.5	615
2.0 (162 kw)	2008.07-2011.06	6AT	F	L/R	Estate 4WD A20NHT		2210450L	Drive Shaft		30	27		94.5	615
	2008.07-2017.05	6AT	F	L/R	Estate FWD A20NFT/A20NHT		2210450L	Drive Shaft		30	27		94.5	615
2.8 (191 kw)	2008.07-2017.05	6AT	F	L	Estate 4WD A28NET	<small>Date To:2010.12,Chassis no. to:A1999999</small>	2210450L	Drive Shaft		30	27		94.5	615
	2008.07-2017.05	6AT	F	R	Estate 4WD A28NET		2210450L	Drive Shaft		30	27		94.5	615
Vivaro														
1.6 (66 kw)	2014.06-	6MT	F	L	Bus FWD R9M408		2025480L	Drive Shaft		29	39	60	95.5	694
	2014.06-	6MT	F	R	Bus FWD R9M408		2184450L	Drive Shaft		29	39	60	95.5	1020
	2014.06-	6MT	F	L	Van FWD R9M408		2025480L	Drive Shaft		29	39	60	95.5	694
	2014.06-	6MT	F	R	Van FWD R9M408		2184450L	Drive Shaft		29	39	60	95.5	1020
1.6 (70 kw)	2016.08-	6MT	F	L	Bus FWD R9M413/R9M415		2025480L	Drive Shaft		29	39	60	95.5	694
	2016.08-	6MT	F	R	Bus FWD R9M413/R9M415		2184450L	Drive Shaft		29	39	60	95.5	1020
	2016.08-	6MT	F	L	Van FWD R9M413/R9M415		2025480L	Drive Shaft		29	39	60	95.5	694
	2016.08-	6MT	F	R	Van FWD R9M413/R9M415		2184450L	Drive Shaft		29	39	60	95.5	1020
1.6 (85 kw)	2014.06-	6MT	F	L	Bus FWD R9M408		2025480L	Drive Shaft		29	39	60	95.5	694
	2014.06-	6MT	F	R	Bus FWD R9M408		2184450L	Drive Shaft		29	39	60	95.5	1020
	2014.06-	6MT	F	L	Platform/Chassis FWD R9M408		2025480L	Drive Shaft		29	39	60	95.5	694
	2014.06-	6MT	F	R	Platform/Chassis FWD R9M408		2184450L	Drive Shaft		29	39	60	95.5	1020
	2014.06-	6MT	F	L	Van FWD R9M408		2025480L	Drive Shaft		29	39	60	95.5	694
	2014.06-	6MT	F	R	Van FWD R9M408		2184450L	Drive Shaft		29	39	60	95.5	1020
1.6 (88 kw)	2014.06-	6MT	F	L	Bus FWD R9M450		2025480L	Drive Shaft		29	39	60	95.5	694
	2014.06-	6MT	F	R	Bus FWD R9M450		2184450L	Drive Shaft		29	39	60	95.5	1020
	2014.06-	6MT	F	L	Platform/Chassis FWD R9M450		2025480L	Drive Shaft		29	39	60	95.5	694
	2014.06-	6MT	F	R	Platform/Chassis FWD R9M450		2184450L	Drive Shaft		29	39	60	95.5	1020





		TRANSM.	F/R	L/R	BODY STYLE & DRIVE TYPE & ENGINE	REMARKS	GSP Ref.		ABS	Technical Specifications				
										A	B	C	H	L
VAUXHALL														
Vivaro														
1.6 (88 kw)	2014.06-	6MT	F	L	Van FWD R9M450		2025480L	Drive Shaft		29	39	60	95.5	694
	2014.06-	6MT	F	R	Van FWD R9M450		2184450L	Drive Shaft		29	39	60	95.5	1020
1.6 (89 kw)	2016.08-	6MT	F	L	Van FWD R9M413/R9M415		2025480L	Drive Shaft		29	39	60	95.5	694
	2016.08-	6MT	F	R	Van FWD R9M413/R9M415		2184450L	Drive Shaft		29	39	60	95.5	1020
	2019.01-	6MT	F	L	Bus FWD R9M415		2025480L	Drive Shaft		29	39	60	95.5	694
	2019.01-	6MT	F	R	Bus FWD R9M415		2184450L	Drive Shaft		29	39	60	95.5	1020
1.6 (92 kw)	2015.08-	6MT	F	L	Bus FWD R9M452		2025480L	Drive Shaft		29	39	60	95.5	694
	2015.08-	6MT	F	R	Bus FWD R9M452		2184450L	Drive Shaft		29	39	60	95.5	1020
	2016.08-	6MT	F	L	Platform/Chassis FWD R9M452		2025480L	Drive Shaft		29	39	60	95.5	694
	2016.08-	6MT	F	R	Platform/Chassis FWD R9M452		2184450L	Drive Shaft		29	39	60	95.5	1020
	2016.08-	6MT	F	L	Van FWD R9M452		2025480L	Drive Shaft		29	39	60	95.5	694
	2016.08-	6MT	F	R	Van FWD R9M452		2184450L	Drive Shaft		29	39	60	95.5	1020
1.6 (103 kw)	2014.06-	6MT	F	L	Bus FWD R9M450		2025480L	Drive Shaft		29	39	60	95.5	694
	2014.06-	6MT	F	R	Bus FWD R9M450		2184450L	Drive Shaft		29	39	60	95.5	1020
	2014.06-	MT	F	L	Platform/Chassis FWD R9M450		2025480L	Drive Shaft		29	39	60	95.5	694
	2014.06-	MT	F	R	Platform/Chassis FWD R9M450		2184450L	Drive Shaft		29	39	60	95.5	1020
	2014.06-	6MT	F	L	Van FWD R9M450		2025480L	Drive Shaft		29	39	60	95.5	694
	2014.06-	6MT	F	R	Van FWD R9M450		2184450L	Drive Shaft		29	39	60	95.5	1020
1.6 (107 kw)	2016.08-	MT	F	L	Platform/Chassis FWD R9M452		2025480L	Drive Shaft		29	39	60	95.5	694
	2016.08-	MT	F	R	Platform/Chassis FWD R9M452		2184450L	Drive Shaft		29	39	60	95.5	1020
	2016.08-	6MT	F	L	Van FWD R9M452		2025480L	Drive Shaft		29	39	60	95.5	694
	2016.08-	6MT	F	R	Van FWD R9M452		2184450L	Drive Shaft		29	39	60	95.5	1020
VOLVO														
S60														
1.5 (90 kw)	2015.10-2018.05	6AT	F	L	Saloon FWD B4154T5		2036400L	Drive Shaft		40	26	57.4	52	576
	2015.10-2018.05	6AT	F	R	Saloon FWD B4154T5		2036610L	Drive Shaft		40	26	57.4	52	953
1.5 (112 kw)	2015.03-2018.05	6AT	F	L	Saloon FWD B4154T4		2036400L	Drive Shaft		40	26	57.4	52	576
	2015.03-2018.05	6AT	F	R	Saloon FWD B4154T4		2036610L	Drive Shaft		40	26	57.4	52	953
1.6 (110 kw)	2010.04-2016.12	6MT	F	L	Saloon FWD B4164T3		2992110L	Drive Shaft		40	26	57.4	51	603
	2010.04-2016.12	6MT	F	R	Saloon FWD B4164T3		2620840L	Drive Shaft		40	26	57.4	51	963
1.6 (132 kw)	2010.04-2016.12	6MT	F	L	Saloon FWD B4164T		2992110L	Drive Shaft		40	26	57.4	51	603
	2010.04-2016.12	6MT	F	R	Saloon FWD B4164T		2620840L	Drive Shaft		40	26	57.4	51	963
	2011.04-2016.12	6MT	F	L	Saloon FWD B4164T2		2992110L	Drive Shaft		40	26	57.4	51	603
	2011.04-2016.12	6MT	F	R	Saloon FWD B4164T2		2620840L	Drive Shaft		40	26	57.4	51	963
2.0 (88 kw)	2015.03-2018.05	6AT	F	L	Saloon FWD D4204T20/D4204T8		2036400L	Drive Shaft		40	26	57.4	52	576
	2015.03-2018.05	6AT	F	R	Saloon FWD D4204T20/D4204T8		2036610L	Drive Shaft		40	26	57.4	52	953
	2015.03-2018.05	6MT	F	L	Saloon FWD D4204T20/D4204T8		2621190L	Drive Shaft		40	31	57.4	52	599
	2015.03-2018.05	6MT	F	R	Saloon FWD D4204T20/D4204T8		2621170L	Drive Shaft		40	28	57.4	52	949
2.0 (100 kw)	2012.09-2016.12	6MT	F	L	Saloon FWD D5204T7		2210700L	Drive Shaft		40	26	57.4	52	556
	2012.09-2016.12	6MT	F	R	Saloon FWD D5204T7		2620860L	Drive Shaft		40	26	57.4	52	1002
2.0 (110 kw)	2015.03-2018.05	6AT	F	L	Saloon FWD D4204T9		2036400L	Drive Shaft		40	26	57.4	52	576
	2015.03-2018.05	6AT	F	R	Saloon FWD D4204T9		2036610L	Drive Shaft		40	26	57.4	52	953
	2015.03-2018.05	6MT	F	L	Saloon FWD D4204T9		2621190L	Drive Shaft		40	31	57.4	52	599
	2015.03-2018.05	6MT	F	R	Saloon FWD D4204T9		2621170L	Drive Shaft		40	28	57.4	52	949
2.0 (112 kw)	2015.03-2018.05	6MT	F	L	Saloon FWD B4204T37		2621190L	Drive Shaft		40	31	57.4	52	599
	2015.03-2018.05	6MT	F	R	Saloon FWD B4204T37		2621170L	Drive Shaft		40	28	57.4	52	949
2.0 (120 kw)	2010.04-2016.12	6MT	F	L	Saloon FWD D5204T2/D5204T3		2210700L	Drive Shaft		40	26	57.4	52	556
	2010.04-2016.12	6MT	F	R	Saloon FWD D5204T2/D5204T3		2620860L	Drive Shaft		40	26	57.4	52	1002
2.0 (133 kw)	2013.09-2015.12	6MT	F	L	Saloon FWD D4204T5		2621190L	Drive Shaft		40	31	57.4	52	599
	2013.09-2015.12	6MT	F	R	Saloon FWD D4204T5		2621170L	Drive Shaft		40	28	57.4	52	949
2.0 (140 kw)	2015.03-2018.05	6AT	F	L	Saloon FWD B4204T19		2036400L	Drive Shaft		40	26	57.4	52	576
	2015.03-2018.05	6AT	F	R	Saloon FWD B4204T19		2036610L	Drive Shaft		40	26	57.4	52	953
	2015.03-2018.05	6MT	F	L	Saloon FWD B4204T19		2621190L	Drive Shaft		40	31	57.4	52	599
	2015.03-2018.05	6MT	F	R	Saloon FWD B4204T19		2621170L	Drive Shaft		40	28	57.4	52	949
	2015.03-2018.05	6MT	F	L	Saloon FWD D4204T14		2621190L	Drive Shaft		40	31	57.4	52	599
	2015.03-2018.05	6MT	F	R	Saloon FWD D4204T14		2621170L	Drive Shaft		40	28	57.4	52	949
2.0 (147 kw)	2015.03-2018.05	6MT	F	L	Saloon FWD D4204T14		2621190L	Drive Shaft		40	31	57.4	52	599
	2015.03-2018.05	6MT	F	R	Saloon FWD D4204T14		2621170L	Drive Shaft		40	28	57.4	52	949
2.4 (151 kw)	2010.04-2011.05	6MT	F	L	Saloon FWD D5244T10		2210700L	Drive Shaft		40	26	57.4	52	556
	2010.04-2011.05	6MT	F	R	Saloon FWD D5244T10		2620860L	Drive Shaft		40	26	57.4	52	1002
2.4 (158 kw)	2011.06-2015.12	6MT	F	L	Saloon FWD D5244T11/D5244T15		2210700L	Drive Shaft		40	26	57.4	52	556
	2011.06-2015.12	6MT	F	R	Saloon FWD D5244T11/D5244T15		2620860L	Drive Shaft		40	26	57.4	52	1002
2.4 (169 kw)	2014.04-2015.12	6MT	F	L	Saloon FWD D5244T11/D5244T15		2210700L	Drive Shaft		40	26	57.4	52	556
	2014.04-2015.12	6MT	F	R	Saloon FWD D5244T11/D5244T15		2620860L	Drive Shaft		40	26	57.4	52	1002



	 YEAR	TRANSM.	F/R	L/R	BODY STYLE & DRIVE TYPE & ENGINE	REMARKS	GSP Ref.	 PRODUCT	 ABS	Technical Specifications				
										A	B	C	H	L
VOLVO														
S60 Cross Country														
2.0 (110 kw)	2016.06-2018.05	6MT	F	L	Saloon FWD D4204T4		2621190L	Drive Shaft		40	31	57.4	52	599
2.0 (140 kw)	2015.03-2018.05	6MT	F	L	Saloon FWD D4204T14		2621190L	Drive Shaft		40	31	57.4	52	599
S80														
1.6 (132 kw)	2010.11-2014.04	6MT	F	L	Saloon FWD B4164T		2992110L	Drive Shaft		40	26	57.4	51	603
	2010.11-2014.04	6MT	F	R	Saloon FWD B4164T		2620840L	Drive Shaft		40	26	57.4	51	963
	2011.05-2012.11	6MT	F	L	Saloon FWD B4164T2		2992110L	Drive Shaft		40	26	57.4	51	603
	2011.05-2012.11	6MT	F	R	Saloon FWD B4164T2		2620840L	Drive Shaft		40	26	57.4	51	963
2.0 (100 kw)	2012.09-2014.05	6MT	F	L	Saloon FWD D5204T7		2210700L	Drive Shaft		40	26	57.4	52	556
	2012.09-2014.05	6MT	F	R	Saloon FWD D5204T7		2620860L	Drive Shaft		40	26	57.4	52	1002
2.0 (120 kw)	2010.09-2016.12	6MT	F	L	Saloon FWD D5204T2/D5204T3		2210700L	Drive Shaft		40	26	57.4	52	556
	2010.09-2016.12	6MT	F	R	Saloon FWD D5204T2/D5204T3		2620860L	Drive Shaft		40	26	57.4	52	1002
2.0 (133 kw)	2013.09-2016.12	6MT	F	L	Saloon FWD D4204T5		2621190L	Drive Shaft		40	31	57.4	52	599
	2013.09-2016.12	6MT	F	R	Saloon FWD D4204T5		2621170L	Drive Shaft		40	28	57.4	52	949
2.4 (120 kw)	2006.08-2010.03	6MT	F	L	Saloon FWD D5244T5		2210700L	Drive Shaft		40	26	57.4	52	556
	2006.08-2010.03	6MT	F	R	Saloon FWD D5244T5		2620860L	Drive Shaft		40	26	57.4	52	1002
2.4 (129 kw)	2009.05-2011.03	6MT	F	L	Saloon FWD D5244T14		2210700L	Drive Shaft		40	26	57.4	52	556
	2009.05-2011.03	6MT	F	R	Saloon FWD D5244T14		2620860L	Drive Shaft		40	26	57.4	52	1002
2.4 (136 kw)	2006.08-2009.05	6MT	F	L	Saloon FWD D5244T4		2210700L	Drive Shaft		40	26	57.4	52	556
	2006.08-2009.05	6MT	F	R	Saloon FWD D5244T4		2620860L	Drive Shaft		40	26	57.4	52	1002
2.4 (151 kw)	2009.01-2011.12	6MT	F	L	Saloon FWD D5244T10		2210700L	Drive Shaft		40	26	57.4	52	556
	2009.01-2011.12	6MT	F	R	Saloon FWD D5244T10		2620860L	Drive Shaft		40	26	57.4	52	1002
2.4 (158 kw)	2011.06-2015.04	6MT	F	L	Saloon FWD D5244T11/D5244T15		2210700L	Drive Shaft		40	26	57.4	52	556
	2011.06-2015.04	6MT	F	R	Saloon FWD D5244T11/D5244T15		2620860L	Drive Shaft		40	26	57.4	52	1002
2.5 (147 kw)	2006.08-2009.12	6MT	F	L	Saloon FWD B5254T6		2210700L	Drive Shaft		40	26	57.4	52	556
	2006.08-2009.12	6MT	F	R	Saloon FWD B5254T6		2620860L	Drive Shaft		40	26	57.4	52	1002
	2008.05-2012.03	6MT	F	L	Saloon FWD B5254T8		2210700L	Drive Shaft		40	26	57.4	52	556
	2008.05-2012.03	6MT	F	R	Saloon FWD B5254T8		2620860L	Drive Shaft		40	26	57.4	52	1002
2.5 (170 kw)	2010.01-2011.12	6MT	F	L	Saloon FWD B5254T11		2210700L	Drive Shaft		40	26	57.4	52	556
	2010.01-2011.12	6MT	F	R	Saloon FWD B5254T11		2620860L	Drive Shaft		40	26	57.4	52	1002
	2010.01-2012.12	6MT	F	L	Saloon FWD B5254T10		2210700L	Drive Shaft		40	26	57.4	52	556
	2010.01-2012.12	6MT	F	R	Saloon FWD B5254T10		2620860L	Drive Shaft		40	26	57.4	52	1002
S90														
2.0 (110 kw)	2016.03-	6AT/8AT	F	L	Saloon FWD D4204T16/D4204T9		2036400L	Drive Shaft		40	26	57.4	52	576
V60														
1.5 (90 kw)	2016.01-2017.03	6AT	F	L	Estate FWD B4154T5		2036400L	Drive Shaft		40	26	57.4	52	576
	2016.01-2017.03	6AT	F	R	Estate FWD B4154T5		2036610L	Drive Shaft		40	26	57.4	52	953
1.5 (112 kw)	2015.03-2018.05	6AT	F	L	Estate FWD B4154T4		2036400L	Drive Shaft		40	26	57.4	52	576
	2015.03-2018.05	6AT	F	R	Estate FWD B4154T4		2036610L	Drive Shaft		40	26	57.4	52	953
1.6 (110 kw)	2010.11-2015.12	6MT	F	L	Estate FWD B4164T3		2992110L	Drive Shaft		40	26	57.4	51	603
	2010.11-2015.12	6MT	F	R	Estate FWD B4164T3		2620840L	Drive Shaft		40	26	57.4	51	963
1.6 (132 kw)	2010.11-2015.12	6MT	F	L	Estate FWD B4164T		2992110L	Drive Shaft		40	26	57.4	51	603
	2010.11-2015.12	6MT	F	R	Estate FWD B4164T		2620840L	Drive Shaft		40	26	57.4	51	963
	2011.04-2015.12	6MT	F	L	Estate FWD B4164T2		2992110L	Drive Shaft		40	26	57.4	51	603
	2011.04-2015.12	6MT	F	R	Estate FWD B4164T2		2620840L	Drive Shaft		40	26	57.4	51	963
2.0 (88 kw)	2015.03-2018.05	6AT	F	L	Estate FWD D4204T20/D4204T8		2036400L	Drive Shaft		40	26	57.4	52	576
	2015.03-2018.05	6AT	F	R	Estate FWD D4204T20/D4204T8		2036610L	Drive Shaft		40	26	57.4	52	953
	2015.03-2018.05	6MT	F	L	Estate FWD D4204T20/D4204T8		2621190L	Drive Shaft		40	31	57.4	52	599
	2015.03-2018.05	6MT	F	R	Estate FWD D4204T20/D4204T8		2621170L	Drive Shaft		40	28	57.4	52	949
2.0 (100 kw)	2012.09-2015.12	6MT	F	L	Estate FWD D5204T7		2210700L	Drive Shaft		40	26	57.4	52	556
	2012.09-2015.12	6MT	F	R	Estate FWD D5204T7		2620860L	Drive Shaft		40	26	57.4	52	1002
	2013.09-2015.12	6MT	F	L	Combi Van FWD D5204T7		2210700L	Drive Shaft		40	26	57.4	52	556
	2013.09-2015.12	6MT	F	R	Combi Van FWD D5204T7		2620860L	Drive Shaft		40	26	57.4	52	1002
2.0 (110 kw)	2015.03-2018.05	6AT	F	L	Estate FWD D4204T9		2036400L	Drive Shaft		40	26	57.4	52	576
	2015.03-2018.05	6AT	F	R	Estate FWD D4204T9		2036610L	Drive Shaft		40	26	57.4	52	953
	2015.03-2018.05	6MT	F	L	Estate FWD D4204T9		2621190L	Drive Shaft		40	31	57.4	52	599
	2015.03-2018.05	6MT	F	R	Estate FWD D4204T9		2621170L	Drive Shaft		40	28	57.4	52	949
2.0 (112 kw)	2015.03-2018.05	6MT	F	L	Estate FWD B4204T37		2621190L	Drive Shaft		40	31	57.4	52	599
	2015.03-2018.05	6MT	F	R	Estate FWD B4204T37		2621170L	Drive Shaft		40	28	57.4	52	949
2.0 (120 kw)	2010.09-2015.12	6MT	F	L	Estate FWD D5204T2/D5204T3		2210700L	Drive Shaft		40	26	57.4	52	556
	2010.09-2015.12	6MT	F	R	Estate FWD D5204T2/D5204T3		2620860L	Drive Shaft		40	26	57.4	52	1002
	2013.09-2015.12	6MT	F	L	Combi Van FWD D5204T3		2210700L	Drive Shaft		40	26	57.4	52	556
	2013.09-2015.12	6MT	F	R	Combi Van FWD D5204T3		2620860L	Drive Shaft		40	26	57.4	52	1002
2.0 (133 kw)	2013.10-2015.12	6MT	F	L	Estate FWD D4204T5		2621190L	Drive Shaft		40	31	57.4	52	599
	2013.10-2015.12	6MT	F	R	Estate FWD D4204T5		2621170L	Drive Shaft		40	28	57.4	52	949
2.0 (140 kw)	2015.03-2018.05	6AT	F	L	Estate FWD B4204T19		2036400L	Drive Shaft		40	26	57.4	52	576



	 YEAR	TRANSM.	F/R	L/R	BODY STYLE & DRIVE TYPE & ENGINE	REMARKS	GSP Ref.	 PRODUCT	 ABS	Technical Specifications				
										A	B	C	H	L
VOLVO V60														
2.0 (140 kw)	2015.03-2018.05	6AT	F	R	Estate FWD B4204T19		2036610L	Drive Shaft		40	26	57.4	52	953
	2015.03-2018.05	6MT	F	L	Estate FWD B4204T19		2621190L	Drive Shaft		40	31	57.4	52	599
	2015.03-2018.05	6MT	F	R	Estate FWD B4204T19		2621170L	Drive Shaft		40	28	57.4	52	949
	2015.03-2018.05	6MT	F	L	Estate FWD D4204T14		2621190L	Drive Shaft		40	31	57.4	52	599
	2015.03-2018.05	6MT	F	R	Estate FWD D4204T14		2621170L	Drive Shaft		40	28	57.4	52	949
2.4 (151 kw)	2010.11-2011.05	6MT	F	L	Estate FWD D5244T10		2210700L	Drive Shaft		40	26	57.4	52	556
	2010.11-2011.05	6MT	F	R	Estate FWD D5244T10		2620860L	Drive Shaft		40	26	57.4	52	1002
2.4 (158 kw)	2011.06-2015.12	6MT	F	L	Estate FWD D5244T11/D5244T15		2210700L	Drive Shaft		40	26	57.4	52	556
	2011.06-2015.12	6MT	F	R	Estate FWD D5244T11/D5244T15		2620860L	Drive Shaft		40	26	57.4	52	1002
	2013.09-2015.12	6MT	F	L	Combi Van FWD D5244T11/D5244T15		2210700L	Drive Shaft		40	26	57.4	52	556
	2013.09-2015.12	6MT	F	R	Combi Van FWD D5244T11/D5244T15		2620860L	Drive Shaft		40	26	57.4	52	1002
2.4 (169 kw)	2014.04-2015.12	6MT	F	L	Estate FWD D5244T11/D5244T15		2210700L	Drive Shaft		40	26	57.4	52	556
	2014.04-2015.12	6MT	F	R	Estate FWD D5244T11/D5244T15		2620860L	Drive Shaft		40	26	57.4	52	1002
V60 Cross Country														
2.0 (110 kw)	2018.12-	8AT	F	L	Estate 4WD D4204T4		2032080L	Drive Shaft		40	31	54.1	53	617
	2018.12-	8AT	F	R	Estate 4WD D4204T4		2032070L	Drive Shaft		40	28	54.1	53	995
2.0 (140 kw)	2018.12-	8AT	F	L	Estate 4WD D4204T14		2032080L	Drive Shaft		40	31	54.1	53	617
	2018.12-	8AT	F	R	Estate 4WD D4204T14	To Chassis:69547;From Chassis:69548	2032070L	Drive Shaft		40	28	54.1	53	995
2.0 (147 kw)	2018.02-2020.12	8AT	F	L	Estate 4WD D4204T14		2032080L	Drive Shaft		40	31	54.1	53	617
	2018.02-2020.12	8AT	F	R	Estate 4WD D4204T14	To Chassis:69547;From Chassis:69548	2032070L	Drive Shaft		40	28	54.1	53	995
2.0 (184 kw)	2019.05-	8AT	F	L	Estate 4WD B4204T26		2032080L	Drive Shaft		40	31	54.1	53	617
	2019.05-	8AT	F	R	Estate 4WD B4204T26		2032070L	Drive Shaft		40	28	54.1	53	995
V70														
1.6 (132 kw)	2010.11-	6MT	F	L	Estate FWD B4164T		2992110L	Drive Shaft		40	26	57.4	51	603
	2010.11-	6MT	F	R	Estate FWD B4164T		2620840L	Drive Shaft		40	26	57.4	51	963
	2011.05-	6MT	F	L	Estate FWD B4164T2		2992110L	Drive Shaft		40	26	57.4	51	603
	2011.05-	6MT	F	R	Estate FWD B4164T2		2620840L	Drive Shaft		40	26	57.4	51	963
2.0 (88 kw)	2015.03-2016.04	6AT	F	L	Estate FWD D4204T20		2036400L	Drive Shaft		40	26	57.4	52	576
	2015.03-2016.04	6AT	F	R	Estate FWD D4204T20		2036610L	Drive Shaft		40	26	57.4	52	953
	2015.03-2016.04	6MT	F	L	Estate FWD D4204T20		2621190L	Drive Shaft		40	31	57.4	52	599
	2015.03-2016.04	6MT	F	R	Estate FWD D4204T20		2621170L	Drive Shaft		40	28	57.4	52	949
2.0 (100 kw)	2012.09-	6MT	F	L	Estate FWD D5204T7		2210700L	Drive Shaft		40	26	57.4	52	556
	2012.09-	6MT	F	R	Estate FWD D5204T7		2620860L	Drive Shaft		40	26	57.4	52	1002
	2013.09-	6MT	F	L	Combi Van FWD D5204T7		2210700L	Drive Shaft		40	26	57.4	52	556
	2013.09-	6MT	F	R	Combi Van FWD D5204T7		2620860L	Drive Shaft		40	26	57.4	52	1002
2.0 (110 kw)	2015.03-2016.04	6AT	F	L	Estate FWD D4204T9		2036400L	Drive Shaft		40	26	57.4	52	576
	2015.03-2016.04	6AT	F	R	Estate FWD D4204T9		2036610L	Drive Shaft		40	26	57.4	52	953
	2015.03-2016.04	6MT	F	L	Estate FWD D4204T9		2621190L	Drive Shaft		40	31	57.4	52	599
	2015.03-2016.04	6MT	F	R	Estate FWD D4204T9		2621170L	Drive Shaft		40	28	57.4	52	949
2.0 (120 kw)	2010.03-	6MT	F	L	Estate FWD D5204T2/D5204T3		2210700L	Drive Shaft		40	26	57.4	52	556
	2010.03-	6MT	F	R	Estate FWD D5204T2/D5204T3		2620860L	Drive Shaft		40	26	57.4	52	1002
2.0 (133 kw)	2013.10-2016.04	6MT	F	L	Estate FWD D4204T5		2621190L	Drive Shaft		40	31	57.4	52	599
	2013.10-2016.04	6MT	F	R	Estate FWD D4204T5		2621170L	Drive Shaft		40	28	57.4	52	949
2.0 (140 kw)	2015.03-2016.04	6AT	F	L	Estate FWD B4204T19		2036400L	Drive Shaft		40	26	57.4	52	576
	2015.03-2016.04	6AT	F	R	Estate FWD B4204T19		2036610L	Drive Shaft		40	26	57.4	52	953
	2015.03-2016.04	6MT	F	L	Estate FWD B4204T19		2621190L	Drive Shaft		40	31	57.4	52	599
	2015.03-2016.04	6MT	F	R	Estate FWD B4204T19		2621170L	Drive Shaft		40	28	57.4	52	949
	2015.03-2016.04	6MT	F	L	Estate FWD B4204T19		2621190L	Drive Shaft		40	31	57.4	52	599
2.0 (157 kw)	2013.03-	6MT	F	L	Estate FWD B5204T9		2210700L	Drive Shaft		40	26	57.4	52	556
	2013.03-	6MT	F	R	Estate FWD B5204T9		2620860L	Drive Shaft		40	26	57.4	52	1002
	2013.03-	6MT	F	L	Estate FWD B5204T9CNG		2210700L	Drive Shaft		40	26	57.4	52	556
	2013.03-	6MT	F	R	Estate FWD B5204T9CNG		2620860L	Drive Shaft		40	26	57.4	52	1002
2.4 (120 kw)	2007.08-2009.05	6MT	F	L	Estate FWD D5244T5		2210700L	Drive Shaft		40	26	57.4	52	556
	2007.08-2009.05	6MT	F	R	Estate FWD D5244T5		2620860L	Drive Shaft		40	26	57.4	52	1002
2.4 (129 kw)	2009.05-2010.12	6MT	F	L	Estate FWD D5244T14		2210700L	Drive Shaft		40	26	57.4	52	556
	2009.05-2010.12	6MT	F	R	Estate FWD D5244T14		2620860L	Drive Shaft		40	26	57.4	52	1002
2.4 (136 kw)	2007.08-2009.12	6MT	F	L	Estate FWD D5244T4		2210700L	Drive Shaft		40	26	57.4	52	556
	2007.08-2009.12	6MT	F	R	Estate FWD D5244T4		2620860L	Drive Shaft		40	26	57.4	52	1002
2.4 (151 kw)	2009.05-2012.11	6MT	F	L	Estate FWD D5244T10		2210700L	Drive Shaft		40	26	57.4	52	556
	2009.05-2012.11	6MT	F	R	Estate FWD D5244T10		2620860L	Drive Shaft		40	26	57.4	52	1002
2.4 (158 kw)	2011.06-	6MT	F	L	Estate FWD D5244T11/D5244T15		2210700L	Drive Shaft		40	26	57.4	52	556
	2011.06-	6MT	F	R	Estate FWD D5244T11/D5244T15		2620860L	Drive Shaft		40	26	57.4	52	1002
	2013.09-	6MT	F	L	Combi Van FWD D5244T11/D5244T15		2210700L	Drive Shaft		40	26	57.4	52	556
	2013.09-	6MT	F	R	Combi Van FWD D5244T11/D5244T15		2620860L	Drive Shaft		40	26	57.4	52	1002
2.4 (169 kw)	2013.11-2016.04	6MT	F	L	Estate FWD D5244T11/D5244T15		2210700L	Drive Shaft		40	26	57.4	52	556
	2013.11-2016.04	6MT	F	R	Estate FWD D5244T11/D5244T15		2620860L	Drive Shaft		40	26	57.4	52	1002



		TRANSM.	F/R	L/R	BODY STYLE & DRIVE TYPE & ENGINE	REMARKS	GSP Ref.			Technical Specifications				
										A	B	C	H	L
VOLVO V70														
2.5 (147 kw)	2007.08-2009.12	6MT	F	L	Estate FWD B5254T6		2210700L	Drive Shaft		40	26	57.4	52	556
	2007.08-2009.12	6MT	F	R	Estate FWD B5254T6		2620860L	Drive Shaft		40	26	57.4	52	1002
	2008.05-2010.08	6MT	F	L	Estate FWD B5254T8		2210700L	Drive Shaft		40	26	57.4	52	556
	2008.05-2010.08	6MT	F	R	Estate FWD B5254T8		2620860L	Drive Shaft		40	26	57.4	52	1002
2.5 (170 kw)	2009.05-2012.11	6MT	F	L	Estate FWD B5254T11		2210700L	Drive Shaft		40	26	57.4	52	556
	2009.05-2012.11	6MT	F	R	Estate FWD B5254T11		2620860L	Drive Shaft		40	26	57.4	52	1002
	2009.05-2012.12	6MT	F	L	Estate FWD B5254T10		2210700L	Drive Shaft		40	26	57.4	52	556
	2009.05-2012.12	6MT	F	R	Estate FWD B5254T10		2620860L	Drive Shaft		40	26	57.4	52	1002
V90														
2.0 (110 kw)	2016.03-	6AT	F	L	Estate FWD D4204T16/D4204T9		2036400L	Drive Shaft		40	26	57.4	52	576
V90 Cross Country														
2.0 (120 kw)	2018.09-	8AT	F	L	Estate 4WD D4204T7		2032080L	Drive Shaft		40	31	54.1	53	617
	2018.09-	8AT	F	R	Estate 4WD D4204T7		2032070L	Drive Shaft		40	28	54.1	53	995
2.0 (140 kw)	2016.10-	8AT	F	L	Estate 4WD D4204T14		2032080L	Drive Shaft		40	31	54.1	53	617
	2016.10-	8AT	F	R	Estate 4WD D4204T14		2032070L	Drive Shaft		40	28	54.1	53	995
2.0 (147 kw)	2016.10-	8AT	F	L	Estate 4WD D4204T14		2032080L	Drive Shaft		40	31	54.1	53	617
	2016.10-	8AT	F	R	Estate 4WD D4204T14		2032070L	Drive Shaft		40	28	54.1	53	995
2.0 (173 kw)	2016.10-	8AT	F	L	Estate 4WD D4204T23		2032080L	Drive Shaft		40	31	54.1	53	617
	2016.10-	8AT	F	R	Estate 4WD D4204T23		2032070L	Drive Shaft		40	28	54.1	53	995
2.0 (176 kw)	2016.10-	8AT	F	L	Estate 4WD D4204T23		2032080L	Drive Shaft		40	31	54.1	53	617
	2016.10-	8AT	F	R	Estate 4WD D4204T23		2032070L	Drive Shaft		40	28	54.1	53	995
2.0 (183 kw)	2017.01-	8AT	F	L	Estate 4WD B4204T20		2032080L	Drive Shaft		40	31	54.1	53	617
	2017.01-	8AT	F	R	Estate 4WD B4204T20		2032070L	Drive Shaft		40	28	54.1	53	995
2.0 (184 kw)	2017.10-	8AT	F	L	Estate 4WD B4204T26		2032080L	Drive Shaft		40	31	54.1	53	617
	2017.10-	8AT	F	R	Estate 4WD B4204T26		2032070L	Drive Shaft		40	28	54.1	53	995
2.0 (186 kw)	2017.10-	8AT	F	L	Estate 4WD B4204T26		2032080L	Drive Shaft		40	31	54.1	53	617
	2017.10-	8AT	F	R	Estate 4WD B4204T26		2032070L	Drive Shaft		40	28	54.1	53	995
2.0 (187 kw)	2016.10-2018.12	8AT	F	L	Estate 4WD B4204T23		2032080L	Drive Shaft		40	31	54.1	53	617
	2016.10-2018.12	8AT	F	R	Estate 4WD B4204T23		2032070L	Drive Shaft		40	28	54.1	53	995
2.0 (192 kw)	2016.10-2018.12	8AT	F	L	Estate 4WD B4204T23		2032080L	Drive Shaft		40	31	54.1	53	617
	2016.10-2018.12	8AT	F	R	Estate 4WD B4204T23		2032070L	Drive Shaft		40	28	54.1	53	995
2.0 (228 kw)	2017.10-	8AT	F	L	Estate 4WD B4204T29		2032080L	Drive Shaft		40	31	54.1	53	617
	2017.10-	8AT	F	R	Estate 4WD B4204T29		2032070L	Drive Shaft		40	28	54.1	53	995
2.0 (235 kw)	2016.10-	8AT	F	L	Estate 4WD B4204T27		2032080L	Drive Shaft		40	31	54.1	53	617
	2016.10-	8AT	F	R	Estate 4WD B4204T27		2032070L	Drive Shaft		40	28	54.1	53	995
2.0 (240 kw)	2017.10-	8AT	F	L	Estate 4WD B4204T29		2032080L	Drive Shaft		40	31	54.1	53	617
	2017.10-	8AT	F	R	Estate 4WD B4204T29		2032070L	Drive Shaft		40	28	54.1	53	995
2.0 (246 kw)	2016.10-2017.12	8AT	F	L	Estate 4WD B4204T27		2032080L	Drive Shaft		40	31	54.1	53	617
	2016.10-2017.12	8AT	F	R	Estate 4WD B4204T27		2032070L	Drive Shaft		40	28	54.1	53	995
XC60														
2.0 (100 kw)	2012.09-2015.12	AT	F	L	SUV FWD D5204T7		2013850L	Drive Shaft		40	31	56	52	547
2.0 (110 kw)	2015.03-2017.04	6MT	F	L	SUV FWD D4204T4		2013770L	Drive Shaft		40	31	56	52	623
	2015.03-2017.04	6MT	F	R	SUV FWD D4204T4		2013790L	Drive Shaft		40	28	56	52	977
	2015.03-2017.04	8AT	F	L	SUV FWD D4204T4		2013750L	Drive Shaft		40	31	56	52	596
	2015.03-2017.04	8AT	F	R	SUV FWD D4204T4		2013780L	Drive Shaft		40	28	56	52	976
	2017.03-	AT	F	L	SUV FWD D4204T4		2013750L	Drive Shaft		40	31	56	52	596
	2017.03-	AT	F	R	SUV FWD D4204T4		2013780L	Drive Shaft		40	28	56	52	976
2.0 (120 kw)	2010.04-2017.02	6AT	F	L	SUV FWD D5204T2/D5204T3		2013850L	Drive Shaft		40	31	56	52	547
	2010.04-2017.02	6MT	F	L	SUV FWD D5204T2/D5204T3		2034050L	Drive Shaft		40	31	57.4	52	585
	2013.09-2017.02	6MT	F	L	SUV Van FWD D5204T3		2034050L	Drive Shaft		40	31	57.4	52	585
	2018.12-	8AT	F	L	SUV FWD D4204T7		2032080L	Drive Shaft		40	31	54.1	53	617
	2018.12-	8AT	F	R	SUV FWD D4204T7		2032070L	Drive Shaft		40	28	54.1	53	995
2.0 (133 kw)	2013.10-2017.02	AT	F	L	SUV FWD D4204T5		2013750L	Drive Shaft		40	31	56	52	596
	2013.10-2017.02	AT	F	R	SUV FWD D4204T5		2013780L	Drive Shaft		40	28	56	52	976
	2013.10-2017.02	MT	F	L	SUV FWD D4204T5		2013770L	Drive Shaft		40	31	56	52	623
	2013.10-2017.02	MT	F	R	SUV FWD D4204T5		2013790L	Drive Shaft		40	28	56	52	977
2.0 (140 kw)	2015.03-2017.02	AT	F	L	SUV FWD D4204T14		2013750L	Drive Shaft		40	31	56	52	596
	2015.03-2017.02	AT	F	R	SUV FWD D4204T14		2013780L	Drive Shaft		40	28	56	52	976
	2015.03-2017.02	MT	F	L	SUV FWD D4204T14		2013770L	Drive Shaft		40	31	56	52	623
	2015.03-2017.02	MT	F	R	SUV FWD D4204T14		2013790L	Drive Shaft		40	28	56	52	977
	2017.03-	8AT	F	L	SUV 4WD D4204T14		2032080L	Drive Shaft		40	31	54.1	53	617
	2017.03-	8AT	F	R	SUV 4WD D4204T14		2032070L	Drive Shaft		40	28	54.1	53	995
	2017.03-	8AT	F	L	SUV FWD D4204T14		2032080L	Drive Shaft		40	31	54.1	53	617
	2017.03-	8AT	F	R	SUV FWD D4204T14		2032070L	Drive Shaft		40	28	54.1	53	995
	2018.09-	8AT	F	L	SUV FWD B4204T31		2032080L	Drive Shaft		40	31	54.1	53	617



	 YEAR	TRANSM.	F/R	L/R	BODY STYLE & DRIVE TYPE & ENGINE	REMARKS	GSP Ref.	 PRODUCT	 ABS	Technical Specifications					
										A	B	C	H	L	
VOLVO XC60															
2.0 (147 kw)	2019.01-	8AT	F	L	SUV 4WD D4204T14		2032080L	Drive Shaft		40	31	54.1	53	617	
	2019.01-	8AT	F	R	SUV 4WD D4204T14		2032070L	Drive Shaft		40	28	54.1	53	995	
	2019.01-	8AT	F	L	SUV FWD D4204T14		2032080L	Drive Shaft		40	31	54.1	53	617	
	2019.01-	8AT	F	R	SUV FWD D4204T14		2032070L	Drive Shaft		40	28	54.1	53	995	
2.0 (149 kw)	2010.01-2017.02	AT	F	L	SUV FWD B4204T6		2013850L	Drive Shaft		40	31	56	52	547	
	2010.01-2017.02	AT	F	R	SUV FWD B4204T6		2013870L	Drive Shaft		40	28	57.4	52	1030	
2.0 (155 kw)	2019.07-	8AT	F	L	SUV FWD B4204T31P		2032080L	Drive Shaft		40	31	54.1	53	617	
2.0 (173 kw)	2017.03-	8AT	F	L	SUV 4WD D4204T23		2032080L	Drive Shaft		40	31	54.1	53	617	
	2017.03-	8AT	F	R	SUV 4WD D4204T23		2032070L	Drive Shaft		40	28	54.1	53	995	
2.0 (177 kw)	2017.03-	8AT	F	L	SUV 4WD D4204T23		2032080L	Drive Shaft		40	31	54.1	53	617	
	2017.03-	8AT	F	R	SUV 4WD D4204T23		2032070L	Drive Shaft		40	28	54.1	53	995	
2.0 (180 kw)	2011.09-2017.02	AT	F	L	SUV FWD B4204T11/B4204T41		2013750L	Drive Shaft		40	31	56	52	596	
	2011.09-2017.02	AT	F	R	SUV FWD B4204T11/B4204T41		2013780L	Drive Shaft		40	28	56	52	976	
	2015.09-2017.02	8AT	F	L	SUV 4WD B4204T11		2013750L	Drive Shaft		40	31	56	52	596	
2.0 (183 kw)	2017.10-	8AT	F	L	SUV 4WD B4204T20		2032080L	Drive Shaft		40	31	54.1	53	617	
	2017.10-	8AT	F	R	SUV 4WD B4204T20		2032070L	Drive Shaft		40	28	54.1	53	995	
2.0 (184 kw)	2017.10-	8AT	F	L	SUV 4WD B4204T26		2032080L	Drive Shaft		40	31	54.1	53	617	
	2017.10-	8AT	F	R	SUV 4WD B4204T26		2032070L	Drive Shaft		40	28	54.1	53	995	
	2017.10-	8AT	F	L	SUV FWD B4204T26		2032080L	Drive Shaft		40	31	54.1	53	617	
2.0 (186 kw)	2017.10-	8AT	F	L	SUV 4WD B4204T26P		2032080L	Drive Shaft		40	31	54.1	53	617	
	2017.10-	8AT	F	R	SUV 4WD B4204T26P		2032070L	Drive Shaft		40	28	54.1	53	995	
	2019.05-	8AT	F	L	SUV FWD B4204T26P		2032080L	Drive Shaft		40	31	54.1	53	617	
2.0 (187 kw)	2017.03-2018.12	8AT	F	L	SUV 4WD B4204T23		2032080L	Drive Shaft		40	31	54.1	53	617	
	2017.03-2018.12	8AT	F	R	SUV 4WD B4204T23		2032070L	Drive Shaft		40	28	54.1	53	995	
	2017.03-2018.12	8AT	F	L	SUV FWD B4204T23		2032080L	Drive Shaft		40	31	54.1	53	617	
2.0 (192 kw)	2017.03-2018.12	8AT	F	L	SUV 4WD B4204T23		2032080L	Drive Shaft		40	31	54.1	53	617	
	2017.03-2018.12	8AT	F	R	SUV 4WD B4204T23		2032070L	Drive Shaft		40	28	54.1	53	995	
2.0 (225 kw)	2013.10-2017.02	AT	F	L	SUV FWD B4204T9		2013750L	Drive Shaft		40	31	56	52	596	
	2013.10-2017.02	AT	F	R	SUV FWD B4204T9		2013780L	Drive Shaft		40	28	56	52	976	
	2015.10-2017.02	8AT	F	L	SUV 4WD B4204T9		2013750L	Drive Shaft		40	31	56	52	596	
2.0 (228 kw)	2017.10-	8AT	F	L	SUV 4WD B4204T29		2032080L	Drive Shaft		40	31	54.1	53	617	
	2017.10-	8AT	F	R	SUV 4WD B4204T29		2032070L	Drive Shaft		40	28	54.1	53	995	
2.0 (235 kw)	2017.03-	8AT	F	L	SUV 4WD B4204T27		2032080L	Drive Shaft		40	31	54.1	53	617	
	2017.03-	8AT	F	R	SUV 4WD B4204T27		2032070L	Drive Shaft		40	28	54.1	53	995	
2.0 (240 kw)	2017.10-	8AT	F	L	SUV 4WD B4204T29		2032080L	Drive Shaft		40	31	54.1	53	617	
	2017.10-	8AT	F	R	SUV 4WD B4204T29		2032070L	Drive Shaft		40	28	54.1	53	995	
2.0 (246 kw)	2017.03-	8AT	F	L	SUV 4WD B4204T27		2032080L	Drive Shaft		40	31	54.1	53	617	
	2017.03-	8AT	F	R	SUV 4WD B4204T27		2032070L	Drive Shaft		40	28	54.1	53	995	
2.4 (120 kw)	2008.07-2009.05	6MT	F	L	SUV 4WD D5244T5		2034050L	Drive Shaft		40	31	57.4	52	585	
	2008.07-2009.05	6MT	F	R	SUV 4WD D5244T5		2034060L	Drive Shaft		40	28	57.4	52	1027	
	2009.05-2017.02	6AT	F	R	SUV 4WD D5244T16/D5244T17		2013880L	Drive Shaft		40	28	57.4	52	1024	
	2009.05-2017.02	6MT	F	R	SUV 4WD D5244T16/D5244T17		2034060L	Drive Shaft		40	28	57.4	52	1027	
	2013.09-2017.02	6AT/6MT	F	R	SUV Van 4WD D5244T17		2034060L	Drive Shaft		40	28	57.4	52	1027	
2.4 (129 kw)	2009.05-2017.02	6AT	F	L	SUV FWD D5244T14		2013850L	Drive Shaft		40	31	56	52	547	
	2009.05-2017.02	6MT	F	L	SUV FWD D5244T14		2034050L	Drive Shaft		40	31	57.4	52	585	
2.4 (133 kw)	2013.10-2017.02	6MT	F	L	SUV 4WD D5244T12		2034050L	Drive Shaft		40	31	57.4	52	585	
	2013.10-2017.02	6MT	F	R	SUV 4WD D5244T12		2034060L	Drive Shaft		40	28	57.4	52	1027	
	2013.10-2017.02	AT	F	L	SUV 4WD D5244T12		2013850L	Drive Shaft		40	31	56	52	547	
	2013.10-2017.02	AT	F	R	SUV 4WD D5244T12		2013880L	Drive Shaft		40	28	57.4	52	1024	
2.4 (136 kw)	2008.06-2009.12	6MT	F	R	SUV 4WD D5244T4		2034060L	Drive Shaft		40	28	57.4	52	1027	
2.4 (140 kw)	2015.03-2017.02	6MT	F	L	SUV 4WD D5244T21		2034050L	Drive Shaft		40	31	57.4	52	585	
	2015.03-2017.02	6MT	F	R	SUV 4WD D5244T21		2034060L	Drive Shaft		40	28	57.4	52	1027	
	2015.03-2017.02	AT	F	L	SUV 4WD D5244T21		2013850L	Drive Shaft		40	31	56	52	547	
	2015.03-2017.02	AT	F	R	SUV 4WD D5244T21		2013880L	Drive Shaft		40	28	57.4	52	1024	
2.4 (158 kw)	2011.06-2017.02	6MT	F	L	SUV 4WD D5244T11/D5244T15		2034050L	Drive Shaft		40	31	57.4	52	585	
	2011.06-2017.02	6MT	F	R	SUV 4WD D5244T11/D5244T15		2034060L	Drive Shaft		40	28	57.4	52	1027	
	2013.09-2017.02	6AT/6MT	F	L	SUV Van 4WD D5244T11/D5244T15		2034050L	Drive Shaft		40	31	57.4	52	585	
	2013.09-2017.02	6AT/6MT	F	R	SUV Van 4WD D5244T11/D5244T15		2034060L	Drive Shaft		40	28	57.4	52	1027	
2.4 (162 kw)	2015.03-2017.02	6MT	F	L	SUV 4WD D5244T20/D5244T22		2034050L	Drive Shaft		40	31	57.4	52	585	
	2015.03-2017.02	6MT	F	R	SUV 4WD D5244T20/D5244T22		2034060L	Drive Shaft		40	28	57.4	52	1027	
	2015.03-2017.02	AT	F	L	SUV 4WD D5244T20/D5244T22		2013850L	Drive Shaft		40	31	56	52	547	
	2015.03-2017.02	AT	F	R	SUV 4WD D5244T20/D5244T22		2013880L	Drive Shaft		40	28	57.4	52	1024	
2.4 (169 kw)	2014.04-2017.02	6MT	F	L	SUV 4WD D5244T11/D5244T15		2034050L	Drive Shaft		40	31	57.4	52	585	
	2014.04-2017.02	6MT	F	R	SUV 4WD D5244T11/D5244T15		2034060L	Drive Shaft		40	28	57.4	52	1027	
	2014.04-2017.02	AT	F	L	SUV 4WD D5244T11/D5244T15		2013850L	Drive Shaft		40	31	56	52	547	



	 YEAR	TRANSM.	F/R	L/R	BODY STYLE & DRIVE TYPE & ENGINE	REMARKS	GSP Ref.	 PRODUCT	 ABS	Technical Specifications				
										A	B	C	H	L
VOLVO														
XC60														
2.4 (169 kw)	2014.04-2017.02	AT	F	R	SUV 4WD D5244T11/D5244T15		2013880L	Drive Shaft		40	28	57.4	52	1024
2.5 (183 kw)	2014.04-2017.02	AT	F	L	SUV 4WD B5254T12		2013850L	Drive Shaft		40	31	56	52	547
	2014.04-2017.02	AT	F	R	SUV 4WD B5254T12		2013880L	Drive Shaft		40	28	57.4	52	1024
2.5 (187 kw)	2014.04-2017.02	AT	F	L	SUV 4WD B5254T12		2013850L	Drive Shaft		40	31	56	52	547
	2014.04-2017.02	AT	F	R	SUV 4WD B5254T12		2013880L	Drive Shaft		40	28	57.4	52	1024
3.0 (210 kw)	2008.07-2010.03	AT	F	L	SUV 4WD B6304T2		2013850L	Drive Shaft		40	31	56	52	547
	2008.07-2010.03	AT	F	R	SUV 4WD B6304T2		2013870L	Drive Shaft		40	28	57.4	52	1030
3.0 (224 kw)	2009.03-2017.02	AT	F	L	SUV 4WD B6304T4		2013850L	Drive Shaft		40	31	56	52	547
	2009.03-2017.02	AT	F	R	SUV 4WD B6304T4		2013870L	Drive Shaft		40	28	57.4	52	1030
3.0 (242 kw)	2014.04-2015.12	AT	F	L	SUV 4WD B6304T4		2013850L	Drive Shaft		40	31	56	52	547
	2014.04-2015.12	AT	F	R	SUV 4WD B6304T4		2013870L	Drive Shaft		40	28	57.4	52	1030
3.2 (171 kw)	2011.09-2014.12	AT	F	R	SUV FWD B 6324 S4		2013890L	Drive Shaft		40	28	57.4	52	1030
3.2 (175 kw)	2009.05-2010.12	AT	F	L	SUV 4WD B6324S		2013850L	Drive Shaft		40	31	56	52	547
	2009.05-2010.12	AT	F	R	SUV 4WD B6324S		2013870L	Drive Shaft		40	28	57.4	52	1030
3.2 (179 kw)	2010.01-2017.02		F	R	SUV FWD B6324S4	Chassis no. to:84236	2013870L	Drive Shaft		40	28	57.4	52	1030
	2010.04-2017.02	AT	F	L	SUV 4WD B6324S5		2013850L	Drive Shaft		40	31	56	52	547
	2010.04-2017.02	AT	F	R	SUV 4WD B6324S5		2013870L	Drive Shaft		40	28	57.4	52	1030
XC90														
2.0 (140 kw)	2015.06-2018.12	8AT	F	L	SUV FWD D4204T14		2032080L	Drive Shaft		40	31	54.1	53	617
	2015.10-2018.12	8AT	F	L	SUV 4WD D4204T6		2032080L	Drive Shaft		40	31	54.1	53	617
	2015.10-2018.12	8AT	F	R	SUV 4WD D4204T6		2032070L	Drive Shaft		40	28	54.1	53	995
2.0 (165 kw)	2014.09-2016.12	8AT	F	L	SUV 4WD D4204T11		2032080L	Drive Shaft		40	31	54.1	53	617
	2014.09-2016.12	8AT	F	R	SUV 4WD D4204T11		2032070L	Drive Shaft		40	28	54.1	53	995
2.0 (173 kw)	2016.03-2019.12	8AT	F	L	SUV 4WD D4204T23		2032080L	Drive Shaft		40	31	54.1	53	617
	2016.03-2019.12	8AT	F	R	SUV 4WD D4204T23		2032070L	Drive Shaft		40	28	54.1	53	995
2.0 (176 kw)	2016.03-	8AT	F	L	SUV 4WD D4204T23		2032080L	Drive Shaft		40	31	54.1	53	617
	2016.03-	8AT	F	R	SUV 4WD D4204T23		2032070L	Drive Shaft		40	28	54.1	53	995
	2017.10-	8AT	F	L	SUV 4WD B4204T26		2032080L	Drive Shaft		40	31	54.1	53	617
	2017.10-	8AT	F	R	SUV 4WD B4204T26		2032070L	Drive Shaft		40	28	54.1	53	995
2.0 (177 kw)	2018.10-	8AT	F	L	SUV 4WD D4204T23		2032080L	Drive Shaft		40	31	54.1	53	617
	2018.10-	8AT	F	R	SUV 4WD D4204T23		2032070L	Drive Shaft		40	28	54.1	53	995
2.0 (183 kw)	2016.02-2018.12	8AT	F	L	SUV 4WD B4204T20		2032080L	Drive Shaft		40	31	54.1	53	617
	2016.02-2018.12	8AT	F	R	SUV 4WD B4204T20		2032070L	Drive Shaft		40	28	54.1	53	995
2.0 (184 kw)	2017.10-	8AT	F	L	SUV 4WD B4204T26		2032080L	Drive Shaft		40	31	54.1	53	617
	2017.10-	8AT	F	R	SUV 4WD B4204T26		2032070L	Drive Shaft		40	28	54.1	53	995
2.0 (186 kw)	2019.07-	8AT	F	L	SUV 4WD B4204T26P		2032080L	Drive Shaft		40	31	54.1	53	617
	2019.07-	8AT	F	R	SUV 4WD B4204T26P		2032070L	Drive Shaft		40	28	54.1	53	995
2.0 (187 kw)	2015.06-2018.12	8AT	F	L	SUV 4WD B4204T23		2032080L	Drive Shaft		40	31	54.1	53	617
	2015.06-2018.12	8AT	F	R	SUV 4WD B4204T23		2032070L	Drive Shaft		40	28	54.1	53	995
2.0 (192 kw)	2017.01-	8AT	F	L	SUV 4WD B4204T23		2032080L	Drive Shaft		40	31	54.1	53	617
	2017.01-	8AT	F	R	SUV 4WD B4204T23		2032070L	Drive Shaft		40	28	54.1	53	995
2.0 (228 kw)	2017.10-	8AT	F	L	SUV 4WD B4204T29		2032080L	Drive Shaft		40	31	54.1	53	617
	2017.10-	8AT	F	R	SUV 4WD B4204T29		2032070L	Drive Shaft		40	28	54.1	53	995
2.0 (235 kw)	2014.09-2018.12	8AT	F	L	SUV 4WD B4204T27		2032080L	Drive Shaft		40	31	54.1	53	617
	2014.09-2018.12	8AT	F	R	SUV 4WD B4204T27		2032070L	Drive Shaft		40	28	54.1	53	995
2.0 (240 kw)	2017.10-	8AT	F	L	SUV 4WD B4204T29P		2032080L	Drive Shaft		40	31	54.1	53	617
	2017.10-	8AT	F	R	SUV 4WD B4204T29P		2032070L	Drive Shaft		40	28	54.1	53	995
2.0 (246 kw)	2017.01-	8AT	F	L	SUV 4WD B4204T27		2032080L	Drive Shaft		40	31	54.1	53	617
	2017.01-	8AT	F	R	SUV 4WD B4204T27		2032070L	Drive Shaft		40	28	54.1	53	995
2.4 (120 kw)	2002.06-2014.12	AT	F	L	SUV 4WD D5244T/D5244T5	For Engine Code D5244T5, Chassis no. from:354476	2013710L	Drive Shaft	48T	40	31	56.5	52	552
	2010.10-2014.12	AT	F	L	SUV FWD D5244T5	Date To:2013.12; Chassis no. from:354476	2013710L	Drive Shaft	48T	40	31	56.5	52	552
2.4 (136 kw)	2005.05-2014.12	AT	F	L	SUV 4WD D5244T4	Chassis no. from:354476	2013710L	Drive Shaft	48T	40	31	56.5	52	552
2.4 (147 kw)	2010.11-2014.12	AT	F	L	SUV 4WD D5244T18	Chassis no. from:354476	2013710L	Drive Shaft	48T	40	31	56.5	52	552
2.4 (155 kw)	2013.11-2014.09	AT	F	L	SUV 4WD D5244T18	Chassis no. from:354476	2013710L	Drive Shaft	48T	40	31	56.5	52	552
3.2 (175 kw)	2006.04-2014.12	AT	F	L	SUV 4WD B6324S	Chassis no. from:354799	2013710L	Drive Shaft	48T	40	31	56.5	52	552
	2011.09-2014.12	6AT	F	L	SUV FWD B6324S5	Chassis no. from:355741	2013710L	Drive Shaft	48T	40	31	56.5	52	552
3.2 (179 kw)	2011.04-2014.12	AT	F	L	SUV 4WD B6324S5	Chassis no. from:354799	2013710L	Drive Shaft	48T	40	31	56.5	52	552
4.4 (232 kw)	2004.09-2011.12	AT	F	L	SUV 4WD B8444S	Date To:2007.12; Chassis no. from:367134	2013710L	Drive Shaft	48T	40	31	56.5	52	552
	2004.09-2011.12	AT	F	R	SUV 4WD B8444S	Chassis no. to:367133; Date To:2007.12	2014040L	Drive Shaft	48T	36	28	56.5	55	1031
VW														
Amarok														
2.0 (90 kw)	2010.09-2013.10	6MT	F	L/R	Pick up 4WD CDBA/CNFA		2611730L	Drive Shaft		28		64.8	44.5	462
	2010.09-2013.10	6MT	F	L/R	Pick up RWD CDBA/CNFA		2611730L	Drive Shaft		28		64.8	44.5	462
2.0 (103 kw)	2012.05-	6MT	F	L/R	Pick up 4WD CNFB		2611730L	Drive Shaft		28		64.8	44.5	462
	2012.06-	6MT	F	L/R	Pick up RWD CNFB		2611730L	Drive Shaft		28		64.8	44.5	462



	 YEAR	TRANSM.	F/R	L/R	BODY STYLE & DRIVE TYPE & ENGINE	REMARKS	GSP Ref.	 PRODUCT ABS	Technical Specifications				
									A	B	C	H	L
VW Amarok													
2.0 (103 kw)	2012.06-2016.10	6MT	F	L/R	Platform/Chassis 4WD CNFB		2611730L	Drive Shaft	28	64.8	44.5	462	
2.0 (120 kw)	2009.11-2012.08	6AT/6MT	F	L/R	Pick up 4WD CDCA		2611730L	Drive Shaft	28	64.8	44.5	462	
2.0 (132 kw)	2011.11-	8AT/6MT	F	L/R	Pick up 4WD CNEA/CSHA		2611730L	Drive Shaft	28	64.8	44.5	462	
	2012.05-2016.10	8AT/6MT	F	L/R	Platform/Chassis 4WD CNEA/CSHA		2611730L	Drive Shaft	28	64.8	44.5	462	
3.0 (120 kw)	2016.06-	6MT	F	L/R	Pick up 4WD DDXA		2611730L	Drive Shaft	28	64.8	44.5	462	
3.0 (150 kw)	2016.06-	8AT/6MT	F	L/R	Pick up 4WD DDXB		2611730L	Drive Shaft	28	64.8	44.5	462	
	2016.06-	8AT	F	L/R	Platform/Chassis 4WD DDXB	For PR code:0FA/0FU	2611730L	Drive Shaft	28	64.8	44.5	462	
	2016.06-	8AT	F	L/R	Platform/Chassis 4WD DDXB	Date To:2017.07, For PR code:0FX	2611730L	Drive Shaft	28	64.8	44.5	462	
3.0 (165 kw)	2016.06-	8AT	F	L/R	Pick up 4WD DDXC		2611730L	Drive Shaft	28	64.8	44.5	462	
3.0 (190 kw)	2018.05-	8AT	F	L/R	Pick up 4WD DDXE		2611730L	Drive Shaft	28	64.8	44.5	462	
	2018.05-	8AT	F	L/R	Platform/Chassis 4WD DDXE		2611730L	Drive Shaft	28	64.8	44.5	462	
Arteon													
2.0 (110 kw)	2017.03-	6DCT	F	L	Hatchback FWD DBGA/DFGA/DSRA/DSRBD/DTSA/DTSB		2033810L	Drive Shaft	36	59.5	40	485	
	2017.03-	6DCT	F	R	Hatchback FWD DBGA/DFGA/DSRA/DSRBD/DTSA/DTSB		2613450L	Drive Shaft	36	59.5	40	774	
	2017.03-	6MT	F	L	Hatchback FWD DBGA/DFGA/DSRA/DSRBD/DTSA/DTSB		2611000L	Drive Shaft	36	59.5	40.5	514	
	2017.03-	6MT	F	R	Hatchback FWD DBGA/DFGA/DSRA/DSRBD/DTSA/DTSB		2613410L	Drive Shaft	36	59.5	40.5	806	
	2017.03-	7DCT	F	L	Hatchback FWD DBGA/DFGA/DSRA/DSRBD/DTSA/DTSB		2023510L	Drive Shaft	36	37	59.5	40	570
	2017.03-	7DCT	F	R	Hatchback FWD DBGA/DFGA/DSRA/DSRBD/DTSA/DTSB		2036130L	Drive Shaft	36	37	59.5	40	921
2.0 (140 kw)	2017.05-	7AT	F	L	Hatchback 4WD DFHA		2023510L	Drive Shaft	36	37	59.5	40	570
	2017.05-	6MT	F	L	Hatchback FWD DFHA		2611000L	Drive Shaft	36	59.5	40.5	514	
	2017.05-	6MT	F	R	Hatchback FWD DFHA		2613410L	Drive Shaft	36	59.5	40.5	806	
	2017.05-	7DCT	F	L	Hatchback FWD DFHA		2023510L	Drive Shaft	36	37	59.5	40	570
2.0 (147 kw)	2017.05-	7DCT	F	R	Hatchback FWD DFHA		2036130L	Drive Shaft	36	37	59.5	40	921
	2020.09-	7DCT	F	R	Hatchback FWD DTUA		2036130L	Drive Shaft	36	37	59.5	40	921
2.0 (176 kw)	2017.03-2020.07	7AT	F	L	Hatchback 4WD CUAA		2023510L	Drive Shaft	36	37	59.5	40	570
2.0 (200 kw)	2018.04-	7AT	F	R	Hatchback 4WD DLRB/DNUA		2018890L	Drive Shaft	36	59.5	40	614	
2.0 (206 kw)	2017.04-	7AT	F	R	Hatchback 4WD DJHC		2018890L	Drive Shaft	36	59.5	40	614	
Arteon Shooting Brake													
2.0 (110 kw)	2020.06-	7DCT	F	R	Estate FWD DSRA/DSRBD/DTSA/DTSB		2036130L	Drive Shaft	36	37	59.5	40	921
2.0 (140 kw)	2020.09-	7DCT	F	R	Estate FWD DFHA		2036130L	Drive Shaft	36	37	59.5	40	921
2.0 (147 kw)	2020.09-	7DCT	F	R	Estate FWD DTUA		2036130L	Drive Shaft	36	37	59.5	40	921
Beetle													
1.4 (110 kw)	2014.12-2018.09	7AT/6MT	F	L	Cabriolet FWD CZDA		2612810L	Drive Shaft	36	59.5	40.5	525	
	2014.12-2019.07	7AT/6MT	F	L	Hatchback FWD CZDA		2612810L	Drive Shaft	36	59.5	40.5	525	
1.4 (118 kw)	2011.10-2016.07	7DCT	F	L	Cabriolet FWD CAVD/CNWA/CTHD/CTKA		2023560L	Drive Shaft	36	59.5	40.5	534	
	2011.10-2016.07	7DCT	F	L	Hatchback FWD CAVD/CNWA/CTHD/CTKA		2023560L	Drive Shaft	36	59.5	40.5	534	
1.6 (77 kw)	2011.10-2016.07	7DCT	F	L	Hatchback FWD CAYC		2612810L	Drive Shaft	36	59.5	40.5	525	
	2011.10-2016.07	7DCT	F	R	Hatchback FWD CAYC		2613410L	Drive Shaft	36	59.5	40.5	806	
	2012.09-2016.07	7DCT	F	L	Cabriolet FWD CAYC		2612810L	Drive Shaft	36	59.5	40.5	525	
	2012.09-2016.07	7DCT	F	R	Cabriolet FWD CAYC		2613410L	Drive Shaft	36	59.5	40.5	806	
2.0 (81 kw)	2014.12-2018.09	7DCT	F	L	Cabriolet FWD CUUA		2612810L	Drive Shaft	36	59.5	40.5	525	
	2014.12-2018.09	7DCT	F	R	Cabriolet FWD CUUA		2613410L	Drive Shaft	36	59.5	40.5	806	
	2014.12-2018.09	7DCT	F	L	Hatchback FWD CUUA		2612810L	Drive Shaft	36	59.5	40.5	525	
	2014.12-2018.09	7DCT	F	R	Hatchback FWD CUUA		2613410L	Drive Shaft	36	59.5	40.5	806	
2.0 (103 kw)	2011.04-2016.07	6MT	F	R	Hatchback FWD CFFB/CJAA		2613410L	Drive Shaft	36	59.5	40.5	806	
	2012.04-2016.07	6MT	F	R	Cabriolet FWD CFFB/CJAA		2613410L	Drive Shaft	36	59.5	40.5	806	
2.0 (110 kw)	2014.07-2018.09	6MT	F	R	Hatchback FWD CUUB/CVCA/DELA		2613410L	Drive Shaft	36	59.5	40.5	806	
	2014.09-2018.09	6MT	F	R	Cabriolet FWD CUUB/CVCA/DELA		2613410L	Drive Shaft	36	59.5	40.5	806	
2.0 (147 kw)	2010.12-2016.07	6DCT	F	L	Cabriolet FWD CBFA/CCTA/CCZA		2018960L	Drive Shaft	36	59.5	40	500	
	2010.12-2016.07	6DCT	F	R	Cabriolet FWD CBFA/CCTA/CCZA		2033130L	Drive Shaft	36	59.5	40.5	794	
	2011.04-2016.07	6DCT	F	L	Hatchback FWD CBFA/CCTA/CCZA		2018960L	Drive Shaft	36	59.5	40	500	
	2011.04-2016.07	6DCT	F	R	Hatchback FWD CBFA/CCTA/CCZA		2033130L	Drive Shaft	36	59.5	40.5	794	
2.0 (155 kw)	2012.12-2016.07	6DCT	F	R	Cabriolet FWD CPLA/CPPA		2033130L	Drive Shaft	36	59.5	40.5	794	
	2012.12-2016.07	6MT/6DCT	F	L	Cabriolet FWD CPLA/CPPA		2018960L	Drive Shaft	36	59.5	40	500	
	2012.12-2016.07	6DCT	F	L	Hatchback FWD CPLA/CPPA		2018960L	Drive Shaft	36	59.5	40	500	
	2012.12-2016.07	6DCT	F	R	Hatchback FWD CPLA/CPPA		2033130L	Drive Shaft	36	59.5	40.5	794	
2.0 (162 kw)	2014.12-2018.09	6MT/6DCT	F	L	Cabriolet FWD CULC		2018960L	Drive Shaft	36	59.5	40	500	
	2014.12-2018.09	6MT/6DCT	F	L	Hatchback FWD CULC		2018960L	Drive Shaft	36	59.5	40	500	
Bjalla													
1.4 (118 kw)	2011.10-2016.07	7DCT	F	L	Hatchback FWD CAVD/CNWA/CTHD/CTKA		2023560L	Drive Shaft	36	59.5	40.5	534	
2.0 (147 kw)	2011.04-2016.07	6DCT	F	L	Hatchback FWD CBFA/CCTA/CCZA		2018960L	Drive Shaft	36	59.5	40	500	
	2011.04-2016.07	6DCT	F	R	Hatchback FWD CBFA/CCTA/CCZA		2033130L	Drive Shaft	36	59.5	40.5	794	
Caddy													
1.2 (62 kw)	2015.06-2020.09	5MT	F	L	MPV FWD CYVC		2612820L	Drive Shaft	36	59.5	40	523	
	2015.06-2020.09	5MT	F	R	MPV FWD CYVC		2613070L	Drive Shaft	36	59.5	40	820	



 YEAR	TRANSM.	F/R	L/R	BODY STYLE & DRIVE TYPE & ENGINE	REMARKS	GSP Ref.	 PRODUCT	 ABS	Technical Specifications				
									A	B	C	H	L
VW Caddy													
1.2 (62 kw)	2015.06-2020.09	5MT	F	L	MPV Van FWD CYVC		2612820L	Drive Shaft	36	59.5	40	523	
	2015.06-2020.09	5MT	F	R	MPV Van FWD CYVC		2613070L	Drive Shaft	36	59.5	40	820	
1.2 (63 kw)	2010.09-2015.05	5MT	F	L	MPV FWD CBZA		2611000L	Drive Shaft	36	59.5	40.5	514	
	2010.09-2015.05	5MT	F	R	MPV FWD CBZA		2610960L	Drive Shaft	36	59.5	40	800	
	2010.09-2015.05	5MT	F	L	MPV Van FWD CBZA		2611000L	Drive Shaft	36	59.5	40.5	514	
	2010.09-2015.05	5MT	F	R	MPV Van FWD CBZA		2610960L	Drive Shaft	36	59.5	40	800	
1.2 (77 kw)	2010.09-2015.05	5MT	F	L	MPV FWD CBZB		2611000L	Drive Shaft	36	59.5	40.5	514	
	2010.09-2015.05	5MT	F	R	MPV FWD CBZB		2610960L	Drive Shaft	36	59.5	40	800	
	2010.09-2015.05	5MT	F	L	MPV Van FWD CBZB		2611000L	Drive Shaft	36	59.5	40.5	514	
	2010.09-2015.05	5MT	F	R	MPV Van FWD CBZB		2610960L	Drive Shaft	36	59.5	40	800	
1.4 (55 kw)	2004.02-2006.05	5MT	F	L	MPV FWD BCA		2612010L	Drive Shaft	36	59.5	40	536	
	2004.02-2006.05	5MT	F	L	MPV Van FWD BCA		2612010L	Drive Shaft	36	59.5	40	536	
1.4 (59 kw)	2006.05-2010.08	5MT	F	L	MPV FWD BUD		2612010L	Drive Shaft	36	59.5	40	536	
	2006.05-2010.08	MT	F	L	MPV FWD BUD		2032940L	Drive Shaft	36	59.5	40	517	
	2006.05-2010.08	MT	F	R	MPV FWD BUD		2610420L	Drive Shaft	36	59.5	40	814	
	2006.05-2010.08	5MT	F	L	MPV Van FWD BUD		2612010L	Drive Shaft	36	59.5	40	536	
	2006.05-2010.08	MT	F	L	MPV Van FWD BUD		2032940L	Drive Shaft	36	59.5	40	517	
	2006.05-2010.08	MT	F	R	MPV Van FWD BUD		2610420L	Drive Shaft	36	59.5	40	814	
1.4 (81 kw)	2015.05-2020.09	6DCT	F	L	MPV Van FWD CPWA		2032950L	Drive Shaft	36	59.5	40.5	486	
	2015.05-2020.09	6MT	F	L	MPV Van FWD CPWA		2611000L	Drive Shaft	36	59.5	40.5	514	
	2015.05-2020.09	6MT	F	R	MPV Van FWD CPWA		2613410L	Drive Shaft	36	59.5	40.5	806	
	2015.06-2020.09	6DCT	F	L	MPV FWD CPWA		2032950L	Drive Shaft	36	59.5	40.5	486	
	2015.06-2020.09	6MT	F	L	MPV FWD CPWA		2611000L	Drive Shaft	36	59.5	40.5	514	
	2015.06-2020.09	6MT	F	R	MPV FWD CPWA		2613410L	Drive Shaft	36	59.5	40.5	806	
1.4 (92 kw)	2015.05-2020.09	6MT	F	L	MPV FWD CZCB		2611000L	Drive Shaft	36	59.5	40.5	514	
	2015.05-2020.09	6MT	F	R	MPV FWD CZCB		2613410L	Drive Shaft	36	59.5	40.5	806	
	2015.05-2020.09	7DCT	F	R	MPV FWD CZCB	Date from:2016.03	2033130L	Drive Shaft	36	59.5	40.5	794	
	2015.05-2020.09	7DCT	F	R	MPV FWD CZCB	Date to:2016.02	2611470L	Drive Shaft	36	59.5	40.5	795	
	2015.05-2020.09	6MT	F	L	MPV Van FWD CZCB		2611000L	Drive Shaft	36	59.5	40.5	514	
	2015.05-2020.09	6MT	F	R	MPV Van FWD CZCB		2613410L	Drive Shaft	36	59.5	40.5	806	
	2015.05-2020.09	6MT	F	R	MPV Van FWD CZCB		2613410L	Drive Shaft	36	59.5	40.5	806	
1.4 (96 kw)	2018.07-2020.09	7AT/6MT	F	L	MPV FWD DJKD		2611000L	Drive Shaft	36	59.5	40.5	514	
	2018.07-2020.09	7AT/6MT	F	R	MPV FWD DJKD		2613410L	Drive Shaft	36	59.5	40.5	806	
	2019.06-2020.09	6MT	F	R	MPV Van FWD DJKD		2613410L	Drive Shaft	36	59.5	40.5	806	
	2019.06-2020.09	7AT	F	L	MPV Van FWD DJKD		2611000L	Drive Shaft	36	59.5	40.5	514	
1.6 (55 kw)	2010.08-2015.05	5MT	F	L	MPV FWD CAYE	Date To:2014.03	2611000L	Drive Shaft	36	59.5	40.5	514	
	2010.08-2015.05	5MT	F	L	MPV FWD CAYE	for special-purpose vehicles	2611000L	Drive Shaft	36	59.5	40.5	514	
	2010.08-2015.05	5MT	F	L	MPV FWD CAYE	Date From:2014.04	2612820L	Drive Shaft	36	59.5	40	523	
	2010.08-2015.05	5MT	F	R	MPV FWD CAYE	Date From:2014.04	2612830L	Drive Shaft	36	59.5	40	815	
	2010.08-2015.05	5MT	F	R	MPV FWD CAYE	for special-purpose vehicles.Date To:2014.03	2613410L	Drive Shaft	36	59.5	40.5	806	
	2010.08-2015.05		F	R	MPV FWD CAYE		2610420L	Drive Shaft	36	59.5	40	814	
	2010.08-2015.05	5MT	F	L	MPV Van FWD CAYE	Date To:2014.03	2611000L	Drive Shaft	36	59.5	40.5	514	
	2010.08-2015.05	5MT	F	L	MPV Van FWD CAYE	for special-purpose vehicles	2611000L	Drive Shaft	36	59.5	40.5	514	
	2010.08-2015.05	5MT	F	L	MPV Van FWD CAYE	Date From:2014.04	2612820L	Drive Shaft	36	59.5	40	523	
	2010.08-2015.05	5MT	F	R	MPV Van FWD CAYE	Date From:2014.04	2612830L	Drive Shaft	36	59.5	40	815	
	2010.08-2015.05	5MT	F	R	MPV Van FWD CAYE	for special-purpose vehicles.Date To:2014.03	2613410L	Drive Shaft	36	59.5	40.5	806	
	2010.08-2015.05		F	R	MPV Van FWD CAYE		2610420L	Drive Shaft	36	59.5	40	814	
	2015.05-2017.11	5MT	F	L	MPV FWD CAYE	for special-purpose vehicles	2611000L	Drive Shaft	36	59.5	40.5	514	
	2015.05-2017.11	5MT	F	L	MPV FWD CAYE		2612820L	Drive Shaft	36	59.5	40	523	
	2015.05-2017.11	5MT	F	R	MPV FWD CAYE		2612830L	Drive Shaft	36	59.5	40	815	
	2015.05-2017.11	5MT	F	R	MPV FWD CAYE	for special-purpose vehicles	2613410L	Drive Shaft	36	59.5	40.5	806	
	2015.05-2017.11	MT	F	L	MPV FWD CAYE		2032940L	Drive Shaft	36	59.5	40	517	
	2015.05-2017.11		F	R	MPV FWD CAYE		2610420L	Drive Shaft	36	59.5	40	814	
	2015.05-2017.11	5MT	F	L	MPV Van FWD CAYE	for special-purpose vehicles	2611000L	Drive Shaft	36	59.5	40.5	514	
	2015.05-2017.11	5MT	F	L	MPV Van FWD CAYE		2612820L	Drive Shaft	36	59.5	40	523	
2015.05-2017.11	5MT	F	R	MPV Van FWD CAYE		2612830L	Drive Shaft	36	59.5	40	815		
2015.05-2017.11	5MT	F	R	MPV Van FWD CAYE	for special-purpose vehicles	2613410L	Drive Shaft	36	59.5	40.5	806		
2015.05-2017.11	MT	F	L	MPV Van FWD CAYE		2032940L	Drive Shaft	36	59.5	40	517		
2015.05-2017.11		F	R	MPV Van FWD CAYE		2610420L	Drive Shaft	36	59.5	40	814		
1.6 (75 kw)	2004.04-2015.05	5MT	F	L	MPV FWD BGU/BSE/BSF	Model code:2CB/2KB	2033730L	Drive Shaft	36	59.5	40	517	
	2004.04-2015.05	5MT	F	R	MPV FWD BGU/BSE/BSF		2610420L	Drive Shaft	36	59.5	40	814	
	2004.04-2015.05	5MT	F	L	MPV Van FWD BGU/BSE/BSF	Model code:2CA/2KA	2033730L	Drive Shaft	36	59.5	40	517	
	2004.04-2015.05	5MT	F	L	MPV Van FWD BGU/BSE/BSF	Model code:2KH	2612820L	Drive Shaft	36	59.5	40	523	
	2004.04-2015.05	5MT	F	R	MPV Van FWD BGU/BSE/BSF		2610420L	Drive Shaft	36	59.5	40	814	
	2004.04-2015.05	AT	F	R	MPV Van FWD BGU/BSE/BSF		2610940L	Drive Shaft	36	26	59.5	40	884
	2004.04-2015.05	MT	F	L	MPV Van FWD BGU/BSE/BSF		2032940L	Drive Shaft	36	59.5	40	517	



 YEAR	TRANSM.	F/R	L/R	BODY STYLE & DRIVE TYPE & ENGINE	REMARKS	GSP Ref.	 PRODUCT	 ABS	Technical Specifications						
									A	B	C	H	L		
VW Caddy															
1.6 (75 kw)	2010.08-2015.05	5MT	F	L	MPV FWD CAYD		2611000L	Drive Shaft	36	59.5	40.5	514			
	2010.08-2015.05	5MT	F	R	MPV FWD CAYD		2613410L	Drive Shaft	36	59.5	40.5	806			
	2010.08-2015.05	7DCT	F	R	MPV FWD CAYD		2033130L	Drive Shaft	36	59.5	40.5	794			
	2010.08-2015.05	5MT	F	L	MPV Van FWD CAYD		2611000L	Drive Shaft	36	59.5	40.5	514			
	2010.08-2015.05	5MT	F	R	MPV Van FWD CAYD		2613410L	Drive Shaft	36	59.5	40.5	806			
	2010.08-2015.05	7DCT	F	R	MPV Van FWD CAYD		2033130L	Drive Shaft	36	59.5	40.5	794			
	2011.05-2015.05	5MT	F	R	MPV FWD CHGA		2610420L	Drive Shaft	36	59.5	40	814			
	2011.05-2015.05	5MT	F	L	MPV Van FWD CHGA	Date From:2011.08	2612820L	Drive Shaft	36	59.5	40	523			
	2011.05-2015.05	5MT	F	R	MPV Van FWD CHGA		2610420L	Drive Shaft	36	59.5	40	814			
	2015.05-2020.09	5MT	F	L	MPV FWD CAYD		2611000L	Drive Shaft	36	59.5	40.5	514			
	2015.05-2020.09	5MT	F	R	MPV FWD CAYD		2613410L	Drive Shaft	36	59.5	40.5	806			
	2015.05-2020.09	5MT	F	L	MPV Van FWD CAYD		2611000L	Drive Shaft	36	59.5	40.5	514			
	2015.05-2020.09	5MT	F	R	MPV Van FWD CAYD		2613410L	Drive Shaft	36	59.5	40.5	806			
1.6 (81 kw)	2015.11-2020.09	5MT	F	L	MPV FWD CWVA		2612820L	Drive Shaft	36	59.5	40	523			
	2015.11-2020.09	5MT	F	R	MPV FWD CWVA		2613070L	Drive Shaft	36	59.5	40	820			
	2015.11-2020.09	5MT	F	L	MPV Van FWD CWVA		2612820L	Drive Shaft	36	59.5	40	523			
	2015.11-2020.09	5MT	F	R	MPV Van FWD CWVA		2613070L	Drive Shaft	36	59.5	40	820			
1.9 (55 kw)	2005.09-2010.08	5MT	F	L	MPV FWD BSU		2611000L	Drive Shaft	36	59.5	40.5	514			
	2005.09-2010.08	5MT	F	R	MPV FWD BSU		2613410L	Drive Shaft	36	59.5	40.5	806			
	2005.09-2010.08	5MT	F	L	MPV Van FWD BSU		2611000L	Drive Shaft	36	59.5	40.5	514			
	2005.09-2010.08	5MT	F	R	MPV Van FWD BSU		2613410L	Drive Shaft	36	59.5	40.5	806			
1.9 (77 kw)	2004.02-2010.08	5MT	F	L	MPV FWD BJB/BLS		2611000L	Drive Shaft	36	59.5	40.5	514			
	2004.02-2010.08	5MT	F	R	MPV FWD BJB/BLS		2613410L	Drive Shaft	36	59.5	40.5	806			
	2004.02-2010.08	6DCT	F	L	MPV FWD BJB/BLS	Chassis no. from:2K9000001	2033810L	Drive Shaft	36	59.5	40	485			
	2004.02-2010.08	6DCT	F	L	MPV FWD BJB/BLS	chassis no. to:2K8200000	2540130L	Drive Shaft	36	59.5	40.5	482			
	2004.02-2010.08	6DCT	F	R	MPV FWD BJB/BLS		2540110L	Drive Shaft	36	59.5	40.5	760			
	2004.04-2010.08	5MT	F	L	MPV Van FWD BJB/BLS		2611000L	Drive Shaft	36	59.5	40.5	514			
	2004.04-2010.08	5MT	F	R	MPV Van FWD BJB/BLS		2613410L	Drive Shaft	36	59.5	40.5	806			
	2004.04-2010.08	6DCT	F	L	MPV Van FWD BJB/BLS	Chassis no. from:2K9000001	2033810L	Drive Shaft	36	59.5	40	485			
	2004.04-2010.08	6DCT	F	L	MPV Van FWD BJB/BLS	chassis no. to:2K8200000	2540130L	Drive Shaft	36	59.5	40.5	482			
	2004.04-2010.08	6DCT	F	R	MPV Van FWD BJB/BLS		2540110L	Drive Shaft	36	59.5	40.5	760			
	2008.11-2010.08	6MT	F	L	MPV 4WD BLS		2032950L	Drive Shaft	36	59.5	40.5	486			
	2008.11-2010.08	6MT	F	R	MPV 4WD BLS		2032660L	Drive Shaft	36	59.5	40.5	601			
	2008.11-2010.08		F	L	MPV 4WD BLS		2033800L	Drive Shaft	36	59.5	40	487			
	2008.11-2010.08	6MT	F	L	MPV Van 4WD BLS		2032950L	Drive Shaft	36	59.5	40.5	486			
	2008.11-2010.08	6MT	F	R	MPV Van 4WD BLS		2032660L	Drive Shaft	36	59.5	40.5	601			
	2008.11-2010.08	MT	F	L	MPV Van 4WD BLS		2033800L	Drive Shaft	36	59.5	40	487			
2.0 (51 kw)	2004.02-2010.08	5MT	F	L	MPV FWD BDJ/BST		2033730L	Drive Shaft	36	59.5	40	517			
	2004.02-2010.08	5MT	F	R	MPV FWD BDJ/BST		2610420L	Drive Shaft	36	59.5	40	814			
	2004.02-2010.08	5MT	F	L	MPV Van FWD BDJ/BST		2033730L	Drive Shaft	36	59.5	40	517			
	2004.02-2010.08	5MT	F	R	MPV Van FWD BDJ/BST		2610420L	Drive Shaft	36	59.5	40	814			
2.0 (55 kw)	2015.05-2020.09	5MT	F	L	MPV FWD CUUF/DFSF	for special-purpose vehicles	2611000L	Drive Shaft	36	59.5	40.5	514			
	2015.05-2020.09	5MT	F	L	MPV FWD CUUF/DFSF		2612820L	Drive Shaft	36	59.5	40	523			
	2015.05-2020.09	5MT	F	R	MPV FWD CUUF/DFSF		2612830L	Drive Shaft	36	59.5	40	815			
	2015.05-2020.09	5MT	F	R	MPV FWD CUUF/DFSF	for special-purpose vehicles	2613410L	Drive Shaft	36	59.5	40.5	806			
	2015.05-2020.09	MT	F	L	MPV FWD CUUF/DFSF		2032940L	Drive Shaft	36	59.5	40	517			
	2015.05-2020.09		F	R	MPV FWD CUUF/DFSF		2610420L	Drive Shaft	36	59.5	40	814			
	2015.05-2020.09	5MT	F	L	MPV Van FWD CUUF/DFSC/DFSF	for special-purpose vehicles	2611000L	Drive Shaft	36	59.5	40.5	514			
	2015.05-2020.09	5MT	F	L	MPV Van FWD CUUF/DFSC/DFSF		2612820L	Drive Shaft	36	59.5	40	523			
	2015.05-2020.09	5MT	F	R	MPV Van FWD CUUF/DFSC/DFSF		2612830L	Drive Shaft	36	59.5	40	815			
	2015.05-2020.09	5MT	F	R	MPV Van FWD CUUF/DFSC/DFSF	for special-purpose vehicles	2613410L	Drive Shaft	36	59.5	40.5	806			
	2015.05-2020.09	6MT	F	L	MPV Van FWD CUUF/DFSC/DFSF		2032950L	Drive Shaft	36	59.5	40.5	486			
	2015.05-2020.09	MT	F	L	MPV Van FWD CUUF/DFSC/DFSF		2032940L	Drive Shaft	36	59.5	40	517			
	2015.05-2020.09		F	R	MPV Van FWD CUUF/DFSC/DFSF		2610420L	Drive Shaft	36	59.5	40	814			
	2015.11-2019.07	MT	F	L	MPV Van 4WD DFSC	Date From:2016.01	2611000L	Drive Shaft	36	59.5	40.5	514			
2.0 (62 kw)	2010.11-2015.05	6MT	F	R	MPV Van FWD CFHE		2611470L	Drive Shaft	36	59.5	40.5	795			
	2010.11-2015.05		F	L	MPV Van FWD CFHE		2033800L	Drive Shaft	36	59.5	40	487			
	2010.11-2015.05		F	R	MPV Van FWD CFHE		2033130L	Drive Shaft	36	59.5	40.5	794			
	2010.12-2015.05		F	L	MPV Van 4WD CFHE		2033800L	Drive Shaft	36	59.5	40	487			
2.0 (75 kw)	2015.05-2020.09	5MT	F	L	MPV FWD CUUD/DFSD		2611000L	Drive Shaft	36	59.5	40.5	514			
	2015.05-2020.09	5MT	F	R	MPV FWD CUUD/DFSD		2613410L	Drive Shaft	36	59.5	40.5	806			
	2015.05-2020.09	6DCT	F	L	MPV FWD CUUD/DFSD		2033810L	Drive Shaft	36	59.5	40	485			
	2015.05-2020.09	6DCT	F	L	MPV FWD CUUD/DFSD		2540130L	Drive Shaft	36	59.5	40.5	482			
	2015.05-2020.09	6DCT	F	R	MPV FWD CUUD/DFSD		2033540L	Drive Shaft	36	59.5	40	760			
	2015.05-2020.09	5MT	F	L	MPV Van FWD CUUD/DFSD		2611000L	Drive Shaft	36	59.5	40.5	514			





 YEAR	TRANSM.	F/R	L/R	BODY STYLE & DRIVE TYPE & ENGINE	REMARKS	GSP Ref.	 PRODUCT	 ABS	Technical Specifications				
									A	B	C	H	L
VW Caddy													
2.0 (75 kw)													
2015.05-2020.09	5MT	F	R	MPV Van FWD CUUD/DFSD		2613410L	Drive Shaft		36	59.5	40.5	806	
2015.05-2020.09	6DCT	F	L	MPV Van FWD CUUD/DFSD		2033810L	Drive Shaft		36	59.5	40	485	
2015.05-2020.09	6DCT	F	L	MPV Van FWD CUUD/DFSD		2540130L	Drive Shaft		36	59.5	40.5	482	
2015.05-2020.09	6DCT	F	R	MPV Van FWD CUUD/DFSD		2033540L	Drive Shaft		36	59.5	40	760	
2.0 (80 kw)													
2006.04-2015.05	5MT	F	L	MPV FWD BSX	Chassis no. to:2KB005000	2033730L	Drive Shaft		36	59.5	40	517	
2006.04-2015.05	5MT	F	L	MPV FWD BSX	Chassis no. from:2KB200001	2612820L	Drive Shaft		36	59.5	40	523	
2006.04-2015.05	5MT	F	L	MPV FWD BSX	Date From:2011.08	2612820L	Drive Shaft		36	59.5	40	523	
2006.04-2015.05	5MT	F	R	MPV FWD BSX	Chassis no. to:2KB005000	2610420L	Drive Shaft		36	59.5	40	814	
2006.04-2015.05	5MT	F	L	MPV Van FWD BSX	Chassis no. to:2KB005000	2033730L	Drive Shaft		36	59.5	40	517	
2006.04-2015.05	5MT	F	L	MPV Van FWD BSX	Chassis no. from:2KB200001	2612820L	Drive Shaft		36	59.5	40	523	
2006.04-2015.05	5MT	F	L	MPV Van FWD BSX	Date From:2011.08	2612820L	Drive Shaft		36	59.5	40	523	
2006.04-2015.05	5MT	F	R	MPV Van FWD BSX	Chassis no. to:2KB005000	2610420L	Drive Shaft		36	59.5	40	814	
2.0 (81 kw)													
2010.08-2015.05	6MT	F	L	MPV 4WD CFHF		2032950L	Drive Shaft		36	59.5	40.5	486	
2010.08-2015.05	6MT	F	R	MPV 4WD CFHF		2032660L	Drive Shaft		36	59.5	40.5	601	
2010.08-2015.05		F	L	MPV 4WD CFHF		2033800L	Drive Shaft		36	59.5	40	487	
2010.08-2015.05	5MT	F	L	MPV FWD CLCA		2611000L	Drive Shaft		36	59.5	40.5	514	
2010.08-2015.05	5MT	F	R	MPV FWD CLCA		2613410L	Drive Shaft		36	59.5	40.5	806	
2010.08-2015.05	MT	F	L	MPV FWD CLCA		2033800L	Drive Shaft		36	59.5	40	487	
2010.08-2015.05	6MT	F	L	MPV Van 4WD CFHF		2032950L	Drive Shaft		36	59.5	40.5	486	
2010.08-2015.05	6MT	F	R	MPV Van 4WD CFHF		2032660L	Drive Shaft		36	59.5	40.5	601	
2010.08-2015.05	MT	F	L	MPV Van 4WD CFHF		2033800L	Drive Shaft		36	59.5	40	487	
2010.08-2015.05	5MT	F	L	MPV Van FWD CLCA		2611000L	Drive Shaft		36	59.5	40.5	514	
2010.08-2015.05	5MT	F	R	MPV Van FWD CLCA		2613410L	Drive Shaft		36	59.5	40.5	806	
2010.08-2015.05		F	L	MPV Van FWD CLCA		2033800L	Drive Shaft		36	59.5	40	487	
2.0 (90 kw)													
2020.09-	7DCT	F	R	MPV FWD DTRC		2036130L	Drive Shaft		36	37	59.5	40	921
2020.09-	7DCT	F	L	MPV Van FWD DTRC		2023510L	Drive Shaft		36	37	59.5	40	570
2020.09-	7DCT	F	R	MPV Van FWD DTRC		2036130L	Drive Shaft		36	37	59.5	40	921
2.0 (103 kw)													
2007.09-2010.08	6MT	F	L	MPV FWD BMM		2033800L	Drive Shaft		36	59.5	40	487	
2007.09-2010.08	6MT	F	R	MPV FWD BMM		2033130L	Drive Shaft		36	59.5	40.5	794	
2007.09-2010.08	6MT	F	R	MPV FWD BMM		2611470L	Drive Shaft		36	59.5	40.5	795	
2007.09-2010.08	6MT	F	R	MPV Van FWD BMM		2611470L	Drive Shaft		36	59.5	40.5	795	
2007.09-2010.08		F	L	MPV Van FWD BMM		2033800L	Drive Shaft		36	59.5	40	487	
2007.09-2010.08		F	R	MPV Van FWD BMM		2033130L	Drive Shaft		36	59.5	40.5	794	
2010.11-2015.05	AT	F	R	MPV 4WD CFHC		2540110L	Drive Shaft		36	59.5	40.5	760	
2010.11-2015.05	MT	F	L	MPV 4WD CFHC		2033800L	Drive Shaft		36	59.5	40	487	
2010.11-2015.05	6DCT	F	L	MPV FWD CFHC/CLCB		2033810L	Drive Shaft		36	59.5	40	485	
2010.11-2015.05	6DCT	F	L	MPV FWD CFHC/CLCB		2540130L	Drive Shaft		36	59.5	40.5	482	
2010.11-2015.05	6DCT	F	R	MPV FWD CFHC/CLCB		2540110L	Drive Shaft		36	59.5	40.5	760	
2010.11-2015.05	6MT	F	R	MPV FWD CFHC/CLCB		2611470L	Drive Shaft		36	59.5	40.5	795	
2010.11-2015.05	MT	F	L	MPV FWD CFHC/CLCB		2033800L	Drive Shaft		36	59.5	40	487	
2010.11-2015.05		F	R	MPV FWD CFHC/CLCB		2033130L	Drive Shaft		36	59.5	40.5	794	
2010.11-2015.05	AT	F	R	MPV Van 4WD CFHC		2540110L	Drive Shaft		36	59.5	40.5	760	
2010.11-2015.05	MT	F	L	MPV Van 4WD CFHC		2033800L	Drive Shaft		36	59.5	40	487	
2010.11-2015.05	6DCT	F	L	MPV Van FWD CFHC/CLCB		2033810L	Drive Shaft		36	59.5	40	485	
2010.11-2015.05	6DCT	F	L	MPV Van FWD CFHC/CLCB		2540130L	Drive Shaft		36	59.5	40.5	482	
2010.11-2015.05	6DCT	F	R	MPV Van FWD CFHC/CLCB		2540110L	Drive Shaft		36	59.5	40.5	760	
2010.11-2015.05	6MT	F	R	MPV Van FWD CFHC/CLCB		2611470L	Drive Shaft		36	59.5	40.5	795	
2010.11-2015.05	MT	F	L	MPV Van FWD CFHC/CLCB		2033800L	Drive Shaft		36	59.5	40	487	
2010.11-2015.05		F	R	MPV Van FWD CFHC/CLCB		2033130L	Drive Shaft		36	59.5	40.5	794	
2015.05-2020.09	DCT	F	L	MPV 4WD CFHC		2540130L	Drive Shaft		36	59.5	40.5	482	
2015.05-2020.09	6DCT	F	L	MPV FWD CFHC/CLCB		2033810L	Drive Shaft		36	59.5	40	485	
2015.05-2020.09	6DCT	F	L	MPV FWD CFHC/CLCB		2540130L	Drive Shaft		36	59.5	40.5	482	
2015.05-2020.09	6DCT	F	R	MPV FWD CFHC/CLCB		2033540L	Drive Shaft		36	59.5	40	760	
2015.05-2020.09	6MT	F	L	MPV FWD CFHC/CLCB		2032950L	Drive Shaft		36	59.5	40.5	486	
2015.05-2020.09	DCT	F	L	MPV Van 4WD CFHC		2540130L	Drive Shaft		36	59.5	40.5	482	
2015.05-2020.09	6DCT	F	L	MPV Van FWD CFHC/CLCB		2033810L	Drive Shaft		36	59.5	40	485	
2015.05-2020.09	6DCT	F	L	MPV Van FWD CFHC/CLCB		2540130L	Drive Shaft		36	59.5	40.5	482	
2015.05-2020.09	6DCT	F	R	MPV Van FWD CFHC/CLCB		2033540L	Drive Shaft		36	59.5	40	760	
2015.05-2020.09	6MT	F	L	MPV Van FWD CFHC/CLCB		2032950L	Drive Shaft		36	59.5	40.5	486	
2.0 (110 kw)													
2015.05-2020.09	6DCT	F	L	MPV FWD CUUB/DFSB		2033810L	Drive Shaft		36	59.5	40	485	
2015.05-2020.09	6DCT	F	L	MPV FWD CUUB/DFSB		2540130L	Drive Shaft		36	59.5	40.5	482	
2015.05-2020.09	6DCT	F	R	MPV FWD CUUB/DFSB		2033540L	Drive Shaft		36	59.5	40	760	
2015.05-2020.09	6MT	F	L	MPV FWD CUUB/DFSB		2032950L	Drive Shaft		36	59.5	40.5	486	
2015.05-2020.09	6MT	F	R	MPV FWD CUUB/DFSB	Date From:2016.03	2033130L	Drive Shaft		36	59.5	40.5	794	
2015.05-2020.09	6MT	F	R	MPV FWD CUUB/DFSB	Date to:2016.02	2611470L	Drive Shaft		36	59.5	40.5	795	



 YEAR	TRANSM.	F/R	L/R	BODY STYLE & DRIVE TYPE & ENGINE	REMARKS	GSP Ref.	 PRODUCT ABS	Technical Specifications					
								A	B	C	H	L	
VW Caddy													
2.0 (110 kw)	2015.05-2020.09	6DCT	F	L	MPV Van FWD CUUB/DFSB	2033810L	Drive Shaft	36	59.5	40	485		
	2015.05-2020.09	6DCT	F	L	MPV Van FWD CUUB/DFSB	2540130L	Drive Shaft	36	59.5	40.5	482		
	2015.05-2020.09	6DCT	F	R	MPV Van FWD CUUB/DFSB	2033540L	Drive Shaft	36	59.5	40	760		
	2015.05-2020.09	6MT	F	L	MPV Van FWD CUUB/DFSB	2032950L	Drive Shaft	36	59.5	40.5	486		
2.0 (125 kw)	2012.05-2015.05	6AT	F	L	MPV FWD CFJA	2540130L	Drive Shaft	36	59.5	40.5	482		
	2012.05-2015.05	6AT	F	R	MPV FWD CFJA	2540110L	Drive Shaft	36	59.5	40.5	760		
	2012.05-2015.05	6DCT	F	L	MPV FWD CFJA	2033810L	Drive Shaft	36	59.5	40	485		
	2012.05-2015.05	6AT	F	L	MPV Van FWD CFJA	2540130L	Drive Shaft	36	59.5	40.5	482		
	2012.05-2015.05	6AT	F	R	MPV Van FWD CFJA	2540110L	Drive Shaft	36	59.5	40.5	760		
	2012.05-2015.05	6DCT	F	L	MPV Van FWD CFJA	2033810L	Drive Shaft	36	59.5	40	485		
CADDY ALLTRACK													
1.2 (62 kw)	2015.06-	5MT	F	L	MPV FWD CYVC	2612820L	Drive Shaft	36	59.5	40	523		
	2015.06-	5MT	F	R	MPV FWD CYVC	2613070L	Drive Shaft	36	59.5	40	820		
	2015.06-	5MT	F	L	MPV Van FWD CYVC	2612820L	Drive Shaft	36	59.5	40	523		
	2015.06-	5MT	F	R	MPV Van FWD CYVC	2613070L	Drive Shaft	36	59.5	40	820		
1.4 (81 kw)	2015.06-	6DCT	F	L	MPV FWD CPWA	2032950L	Drive Shaft	36	59.5	40.5	486		
	2015.06-	6MT	F	L	MPV FWD CPWA	2611000L	Drive Shaft	36	59.5	40.5	514		
	2015.06-	6MT	F	R	MPV FWD CPWA	2613410L	Drive Shaft	36	59.5	40.5	806		
	2015.06-	6MT	F	L	MPV Van FWD CPWA	2611000L	Drive Shaft	36	59.5	40.5	514		
	2015.06-	6MT	F	R	MPV Van FWD CPWA	2613410L	Drive Shaft	36	59.5	40.5	806		
	2015.06-	6MT	F	R	MPV Van FWD CPWA	2613410L	Drive Shaft	36	59.5	40.5	806		
1.4 (92 kw)	2015.05-	6MT	F	R	MPV FWD CZCB	2613410L	Drive Shaft	36	59.5	40.5	806		
	2015.05-	7AT/6MT	F	L	MPV FWD CZCB	2611000L	Drive Shaft	36	59.5	40.5	514		
	2015.05-	7DCT	F	R	MPV FWD CZCB	2033130L	Drive Shaft	36	59.5	40.5	794		
	2015.05-	7DCT	F	R	MPV FWD CZCB	2611470L	Drive Shaft	36	59.5	40.5	795		
	2015.05-	6MT	F	L	MPV Van FWD CZCB	2611000L	Drive Shaft	36	59.5	40.5	514		
	2015.05-	6MT	F	R	MPV Van FWD CZCB	2613410L	Drive Shaft	36	59.5	40.5	806		
1.4 (96 kw)	2018.07-	7AT/6MT	F	L	MPV FWD DJKD	2611000L	Drive Shaft	36	59.5	40.5	514		
	2018.07-	7AT/6MT	F	R	MPV FWD DJKD	2613410L	Drive Shaft	36	59.5	40.5	806		
	2019.06-	7AT	F	L	MPV Van FWD DJKD	2611000L	Drive Shaft	36	59.5	40.5	514		
Caddy Alltrack													
1.6 (55 kw)	2015.05-2017.11	5MT	F	L	MPV FWD CAYE	For special-purpose vehicles	2611000L	Drive Shaft	36	59.5	40.5	514	
	2015.05-2017.11	5MT	F	R	MPV FWD CAYE	For special-purpose vehicles	2613410L	Drive Shaft	36	59.5	40.5	806	
	2015.05-2017.11	5MT	F	L	MPV Van FWD CAYE	For special-purpose vehicles	2611000L	Drive Shaft	36	59.5	40.5	514	
	2015.05-2017.11	5MT	F	R	MPV Van FWD CAYE	For special-purpose vehicles	2613410L	Drive Shaft	36	59.5	40.5	806	
CADDY ALLTRACK													
1.6 (75 kw)	2015.05-	7AT/5MT	F	L	MPV FWD CAYD	For special-purpose vehicles	2611000L	Drive Shaft	36	59.5	40.5	514	
	2015.05-	7AT/5MT	F	R	MPV FWD CAYD	For special-purpose vehicles	2613410L	Drive Shaft	36	59.5	40.5	806	
	2015.05-	7AT/5MT	F	L	MPV Van FWD CAYD	For special-purpose vehicles	2611000L	Drive Shaft	36	59.5	40.5	514	
	2015.05-	7AT/5MT	F	R	MPV Van FWD CAYD	For special-purpose vehicles	2613410L	Drive Shaft	36	59.5	40.5	806	
2.0 (55 kw)	2015.05-	5MT	F	L	MPV FWD CUUF/DFSF	for special-purpose vehicles	2611000L	Drive Shaft	36	59.5	40.5	514	
	2015.05-	5MT	F	L	MPV FWD CUUF/DFSF		2612820L	Drive Shaft	36	59.5	40	523	
	2015.05-	5MT	F	R	MPV FWD CUUF/DFSF		2612830L	Drive Shaft	36	59.5	40	815	
	2015.05-	5MT	F	R	MPV FWD CUUF/DFSF	for special-purpose vehicles	2613410L	Drive Shaft	36	59.5	40.5	806	
	2015.05-	MT	F	L	MPV FWD CUUF/DFSF		2032940L	Drive Shaft	36	59.5	40	517	
	2015.05-		F	R	MPV FWD CUUF/DFSF		2610420L	Drive Shaft	36	59.5	40	814	
	2015.05-	5MT	F	L	MPV Van FWD CUUF/DFSC/DFSF	for special-purpose vehicles	2611000L	Drive Shaft	36	59.5	40.5	514	
	2015.05-	5MT	F	L	MPV Van FWD CUUF/DFSC/DFSF		2612820L	Drive Shaft	36	59.5	40	523	
	2015.05-	5MT	F	R	MPV Van FWD CUUF/DFSC/DFSF		2612830L	Drive Shaft	36	59.5	40	815	
	2015.05-	5MT	F	R	MPV Van FWD CUUF/DFSC/DFSF	for special-purpose vehicles	2613410L	Drive Shaft	36	59.5	40.5	806	
	2015.05-	MT	F	L	MPV Van FWD CUUF/DFSC/DFSF		2032940L	Drive Shaft	36	59.5	40	517	
	2015.05-		F	R	MPV Van FWD CUUF/DFSC/DFSF		2610420L	Drive Shaft	36	59.5	40	814	
	2.0 (75 kw)	2015.05-	5MT	F	L	MPV FWD CUUD/DFSD		2611000L	Drive Shaft	36	59.5	40.5	514
		2015.05-	5MT	F	R	MPV FWD CUUD/DFSD		2613410L	Drive Shaft	36	59.5	40.5	806
2015.05-		6DCT	F	L	MPV FWD CUUD/DFSD		2033810L	Drive Shaft	36	59.5	40	485	
2015.05-		6DCT	F	L	MPV FWD CUUD/DFSD		2540130L	Drive Shaft	36	59.5	40.5	482	
2015.05-		6DCT	F	R	MPV FWD CUUD/DFSD		2033540L	Drive Shaft	36	59.5	40	760	
2015.05-		5MT	F	L	MPV Van FWD CUUD/DFSD		2611000L	Drive Shaft	36	59.5	40.5	514	
2015.05-		5MT	F	R	MPV Van FWD CUUD/DFSD		2613410L	Drive Shaft	36	59.5	40.5	806	
2015.05-		6DCT	F	L	MPV Van FWD CUUD/DFSD		2033810L	Drive Shaft	36	59.5	40	485	
2015.05-		6DCT	F	L	MPV Van FWD CUUD/DFSD		2540130L	Drive Shaft	36	59.5	40.5	482	
2015.05-		6DCT	F	R	MPV Van FWD CUUD/DFSD		2033540L	Drive Shaft	36	59.5	40	760	
2.0 (103 kw)		2015.05-	6DCT	F	L	MPV FWD CFHC/CLCB		2033810L	Drive Shaft	36	59.5	40	485
	2015.05-	6DCT	F	L	MPV FWD CFHC/CLCB		2540130L	Drive Shaft	36	59.5	40.5	482	
	2015.05-	6DCT	F	R	MPV FWD CFHC/CLCB		2033540L	Drive Shaft	36	59.5	40	760	
	2015.05-	6MT	F	L	MPV FWD CFHC/CLCB		2032950L	Drive Shaft	36	59.5	40.5	486	



 YEAR	TRANSM.	F/R	L/R	BODY STYLE & DRIVE TYPE & ENGINE	REMARKS	GSP Ref.	 PRODUCT	 ABS	Technical Specifications				
									A	B	C	H	L
VW													
CADDY ALLTRACK													
2.0 (103 kw)	2015.05-	6DCT	F	L	MPV Van FWD CFHC/CLCB	2540130L	Drive Shaft		36	59.5	40.5	482	
	2015.05-	6MT	F	L	MPV Van FWD CFHC/CLCB	2032950L	Drive Shaft		36	59.5	40.5	486	
2.0 (110 kw)	2015.05-	6DCT	F	L	MPV FWD CUUB/DFSB	2033810L	Drive Shaft		36	59.5	40	485	
	2015.05-	6DCT	F	L	MPV FWD CUUB/DFSB	2540130L	Drive Shaft		36	59.5	40.5	482	
	2015.05-	6DCT	F	R	MPV FWD CUUB/DFSB	2033540L	Drive Shaft		36	59.5	40	760	
	2015.05-	6MT	F	L	MPV FWD CUUB/DFSB	2032950L	Drive Shaft		36	59.5	40.5	486	
	2015.05-	6DCT	F	L	MPV Van FWD CUUB/DFSB	2033810L	Drive Shaft		36	59.5	40	485	
	2015.05-	6DCT	F	L	MPV Van FWD CUUB/DFSB	2540130L	Drive Shaft		36	59.5	40.5	482	
	2015.05-	6DCT	F	R	MPV Van FWD CUUB/DFSB	2033540L	Drive Shaft		36	59.5	40	760	
	2015.05-	6MT	F	L	MPV Van FWD CUUB/DFSB	2032950L	Drive Shaft		36	59.5	40.5	486	
Caddy California													
2.0 (90 kw)	2020.09-	7DCT	F	R	MPV FWD DTRC	2036130L	Drive Shaft		36	37	59.5	40	921
Caddy California Maxi													
2.0 (90 kw)	2020.09-	7DCT	F	R	MPV FWD DTRC	2036130L	Drive Shaft		36	37	59.5	40	921
Caddy Maxi													
1.2 (77 kw)	2010.09-2015.05	5MT	F	L	MPV FWD CBZB	2611000L	Drive Shaft		36	59.5	40.5	514	
	2010.09-2015.05	5MT	F	R	MPV FWD CBZB	2610960L	Drive Shaft		36	59.5	40	800	
	2010.09-2015.05	5MT	F	L	MPV Van FWD CBZB	2611000L	Drive Shaft		36	59.5	40.5	514	
	2010.09-2015.05	5MT	F	R	MPV Van FWD CBZB	2610960L	Drive Shaft		36	59.5	40	800	
1.4 (81 kw)	2015.06-2020.09	6DCT	F	L	MPV FWD CPWA	2032950L	Drive Shaft		36	59.5	40.5	486	
	2015.06-2020.09	6MT	F	L	MPV FWD CPWA	2611000L	Drive Shaft		36	59.5	40.5	514	
	2015.06-2020.09	6MT	F	R	MPV FWD CPWA	2613410L	Drive Shaft		36	59.5	40.5	806	
	2015.06-2020.09	6DCT	F	L	MPV Van FWD CPWA	2032950L	Drive Shaft		36	59.5	40.5	486	
	2015.06-2020.09	6MT	F	L	MPV Van FWD CPWA	2611000L	Drive Shaft		36	59.5	40.5	514	
	2015.06-2020.09	6MT	F	R	MPV Van FWD CPWA	2613410L	Drive Shaft		36	59.5	40.5	806	
1.4 (92 kw)	2015.05-2020.09	6MT	F	L	MPV FWD CZCB	2611000L	Drive Shaft		36	59.5	40.5	514	
	2015.05-2020.09	6MT	F	R	MPV FWD CZCB	2613410L	Drive Shaft		36	59.5	40.5	806	
	2015.05-2020.09	7DCT	F	R	MPV FWD CZCB	Date from:2016.03 2033130L	Drive Shaft		36	59.5	40.5	794	
	2015.05-2020.09	7DCT	F	R	MPV FWD CZCB	Date to:2016.02 2611470L	Drive Shaft		36	59.5	40.5	795	
	2015.05-2020.09	6MT	F	L	MPV Van FWD CZCB	2611000L	Drive Shaft		36	59.5	40.5	514	
	2015.05-2020.09	6MT	F	R	MPV Van FWD CZCB	2613410L	Drive Shaft		36	59.5	40.5	806	
1.4 (96 kw)	2018.07-2020.09	7AT/6MT	F	L	MPV FWD DJKD	2611000L	Drive Shaft		36	59.5	40.5	514	
	2018.07-2020.09	7AT/6MT	F	R	MPV FWD DJKD	2613410L	Drive Shaft		36	59.5	40.5	806	
	2019.06-2020.09	6MT	F	R	MPV Van FWD DJKD	2613410L	Drive Shaft		36	59.5	40.5	806	
	2019.06-2020.09	7AT	F	L	MPV Van FWD DJKD	2611000L	Drive Shaft		36	59.5	40.5	514	
	2010.08-2015.05	5MT	F	L	MPV Van FWD CAYE	Date To:2014.03 2611000L	Drive Shaft		36	59.5	40.5	514	
1.6 (55 kw)	2010.08-2015.05	5MT	F	L	MPV Van FWD CAYE	for special-purpose vehicles 2611000L	Drive Shaft		36	59.5	40.5	514	
	2010.08-2015.05	5MT	F	R	MPV Van FWD CAYE	for special-purpose vehicles, Date To:2014.03 2613410L	Drive Shaft		36	59.5	40.5	806	
	2015.05-2017.11	5MT	F	L	MPV Van FWD CAYE	for special-purpose vehicles 2611000L	Drive Shaft		36	59.5	40.5	514	
	2015.05-2017.11	5MT	F	L	MPV Van FWD CAYE	2612820L	Drive Shaft		36	59.5	40	523	
	2015.05-2017.11	5MT	F	R	MPV Van FWD CAYE	2612830L	Drive Shaft		36	59.5	40	815	
	2015.05-2017.11	5MT	F	R	MPV Van FWD CAYE	for special-purpose vehicles 2613410L	Drive Shaft		36	59.5	40.5	806	
	2015.05-2017.11	MT	F	L	MPV Van FWD CAYE	2032940L	Drive Shaft		36	59.5	40	517	
	2015.05-2017.11		F	R	MPV Van FWD CAYE	2610420L	Drive Shaft		36	59.5	40	814	
	1.6 (75 kw)	2007.11-2010.08	5MT	F	L	MPV FWD BSE/BSF	Model code:2KJ 2612820L	Drive Shaft		36	59.5	40	523
2007.11-2010.08		5MT	F	R	MPV FWD BSE/BSF	2610420L	Drive Shaft		36	59.5	40	814	
2007.11-2010.08		5MT	F	L	MPV Van FWD BSE/BSF	Model code:2CA/2KA 2033730L	Drive Shaft		36	59.5	40	517	
2007.11-2010.08		5MT	F	L	MPV Van FWD BSE/BSF	Model code:2KH 2612820L	Drive Shaft		36	59.5	40	523	
2007.11-2010.08		5MT	F	R	MPV Van FWD BSE/BSF	2610420L	Drive Shaft		36	59.5	40	814	
2007.11-2010.08		AT	F	R	MPV Van FWD BSE/BSF	2610940L	Drive Shaft		36	26	59.5	40	884
2007.11-2010.08		MT	F	L	MPV Van FWD BSE/BSF	2032940L	Drive Shaft		36	59.5	40	517	
2010.08-2015.05		5MT	F	L	MPV FWD CAYD	2611000L	Drive Shaft		36	59.5	40.5	514	
2010.08-2015.05		5MT	F	R	MPV FWD CAYD	2613410L	Drive Shaft		36	59.5	40.5	806	
2010.08-2015.05		7DCT	F	R	MPV FWD CAYD	2033130L	Drive Shaft		36	59.5	40.5	794	
2010.08-2015.05		5MT	F	L	MPV Van FWD CAYD	2611000L	Drive Shaft		36	59.5	40.5	514	
2010.08-2015.05		5MT	F	R	MPV Van FWD CAYD	2613410L	Drive Shaft		36	59.5	40.5	806	
2010.08-2015.05		7DCT	F	R	MPV Van FWD CAYD	2033130L	Drive Shaft		36	59.5	40.5	794	
2011.05-2015.05		5MT	F	R	MPV FWD CHGA	2610420L	Drive Shaft		36	59.5	40	814	
2011.05-2015.05		5MT	F	L	MPV Van FWD CHGA	Date From:2011.08 2612820L	Drive Shaft		36	59.5	40	523	
2011.05-2015.05		5MT	F	R	MPV Van FWD CHGA	2610420L	Drive Shaft		36	59.5	40	814	
2015.05-2020.09		5MT	F	L	MPV FWD CAYD	2611000L	Drive Shaft		36	59.5	40.5	514	
2015.05-2020.09		5MT	F	R	MPV FWD CAYD	2613410L	Drive Shaft		36	59.5	40.5	806	
2015.05-2020.09		5MT	F	L	MPV Van FWD CAYD	2611000L	Drive Shaft		36	59.5	40.5	514	
2015.05-2020.09		5MT	F	R	MPV Van FWD CAYD	2613410L	Drive Shaft		36	59.5	40.5	806	
1.6 (81 kw)	2015.11-2020.09	5MT	F	L	MPV FWD CWVA	2612820L	Drive Shaft		36	59.5	40	523	



 YEAR	TRANSM.	F/R	L/R	BODY STYLE & DRIVE TYPE & ENGINE	REMARKS	GSP Ref.	 PRODUCT ABS	Technical Specifications				
								A	B	C	H	L
VW Caddy Maxi												
1.6 (81 kw)	2015.11-2020.09	5MT	F	R	MPV FWD CWVA	2613070L	Drive Shaft	36	59.5	40	820	
	2015.11-2020.09	5MT	F	L	MPV Van FWD CWVA	2612820L	Drive Shaft	36	59.5	40	523	
	2015.11-2020.09	5MT	F	R	MPV Van FWD CWVA	2613070L	Drive Shaft	36	59.5	40	820	
1.9 (77 kw)	2007.11-2010.08	5MT	F	L	MPV FWD BJB/BLS	2611000L	Drive Shaft	36	59.5	40.5	514	
	2007.11-2010.08	5MT	F	R	MPV FWD BJB/BLS	2613410L	Drive Shaft	36	59.5	40.5	806	
	2007.11-2010.08	6DCT	F	L	MPV FWD BJB/BLS	Chassis no. from:2K9000001	2033810L	Drive Shaft	36	59.5	40	485
	2007.11-2010.08	6DCT	F	L	MPV FWD BJB/BLS	chassis no. to:2K8200000	2540130L	Drive Shaft	36	59.5	40.5	482
	2007.11-2010.08	6DCT	F	R	MPV FWD BJB/BLS		2540110L	Drive Shaft	36	59.5	40.5	760
	2007.11-2010.08	5MT	F	L	MPV Van FWD BJB/BLS		2611000L	Drive Shaft	36	59.5	40.5	514
	2007.11-2010.08	5MT	F	R	MPV Van FWD BJB/BLS		2613410L	Drive Shaft	36	59.5	40.5	806
	2007.11-2010.08	6DCT	F	L	MPV Van FWD BJB/BLS	Chassis no. from:2K9000001	2033810L	Drive Shaft	36	59.5	40	485
	2007.11-2010.08	6DCT	F	L	MPV Van FWD BJB/BLS	chassis no. to:2K8200000	2540130L	Drive Shaft	36	59.5	40.5	482
	2007.11-2010.08	6DCT	F	R	MPV Van FWD BJB/BLS		2540110L	Drive Shaft	36	59.5	40.5	760
	2009.12-2010.08	6MT	F	L	MPV 4WD BLS		2032950L	Drive Shaft	36	59.5	40.5	486
	2009.12-2010.08	6MT	F	R	MPV 4WD BLS		2032660L	Drive Shaft	36	59.5	40.5	601
	2009.12-2010.08		F	L	MPV 4WD BLS		2033800L	Drive Shaft	36	59.5	40	487
	2009.12-2010.08	6MT	F	L	MPV Van 4WD BLS		2032950L	Drive Shaft	36	59.5	40.5	486
	2009.12-2010.08	6MT	F	R	MPV Van 4WD BLS		2032660L	Drive Shaft	36	59.5	40.5	601
	2009.12-2010.08	MT	F	L	MPV Van 4WD BLS		2033800L	Drive Shaft	36	59.5	40	487
2.0 (55 kw)	2015.05-2015.11	5MT	F	L	MPV FWD CUUF	for special-purpose vehicles	2611000L	Drive Shaft	36	59.5	40.5	514
	2015.05-2015.11	5MT	F	L	MPV FWD CUUF		2612820L	Drive Shaft	36	59.5	40	523
	2015.05-2015.11	5MT	F	R	MPV FWD CUUF		2612830L	Drive Shaft	36	59.5	40	815
	2015.05-2015.11	5MT	F	R	MPV FWD CUUF	for special-purpose vehicles	2613410L	Drive Shaft	36	59.5	40.5	806
	2015.05-2015.11	MT	F	L	MPV FWD CUUF		2032940L	Drive Shaft	36	59.5	40	517
	2015.05-2015.11		F	R	MPV FWD CUUF		2610420L	Drive Shaft	36	59.5	40	814
	2015.05-2020.09	5MT	F	L	MPV Van FWD CUUF/DFSC/DFSF	for special-purpose vehicles	2611000L	Drive Shaft	36	59.5	40.5	514
	2015.05-2020.09	5MT	F	L	MPV Van FWD CUUF/DFSC/DFSF		2612820L	Drive Shaft	36	59.5	40	523
	2015.05-2020.09	5MT	F	R	MPV Van FWD CUUF/DFSC/DFSF		2612830L	Drive Shaft	36	59.5	40	815
	2015.05-2020.09	5MT	F	R	MPV Van FWD CUUF/DFSC/DFSF	for special-purpose vehicles	2613410L	Drive Shaft	36	59.5	40.5	806
	2015.05-2020.09	6MT	F	L	MPV Van FWD CUUF/DFSC/DFSF		2032950L	Drive Shaft	36	59.5	40.5	486
	2015.05-2020.09	MT	F	L	MPV Van FWD CUUF/DFSC/DFSF		2032940L	Drive Shaft	36	59.5	40	517
	2015.05-2020.09		F	R	MPV Van FWD CUUF/DFSC/DFSF		2610420L	Drive Shaft	36	59.5	40	814
2.0 (62 kw)	2010.11-2015.05	6MT	F	R	MPV Van FWD CFHE		2611470L	Drive Shaft	36	59.5	40.5	795
	2010.11-2015.05		F	L	MPV Van FWD CFHE		2033800L	Drive Shaft	36	59.5	40	487
	2010.11-2015.05		F	R	MPV Van FWD CFHE		2033130L	Drive Shaft	36	59.5	40.5	794
	2010.12-2015.05		F	L	MPV Van 4WD CFHE		2033800L	Drive Shaft	36	59.5	40	487
2.0 (75 kw)	2015.05-2020.09	5MT	F	L	MPV FWD CUUD/DFSD		2611000L	Drive Shaft	36	59.5	40.5	514
	2015.05-2020.09	5MT	F	R	MPV FWD CUUD/DFSD		2613410L	Drive Shaft	36	59.5	40.5	806
	2015.05-2020.09	6DCT	F	L	MPV FWD CUUD/DFSD		2033810L	Drive Shaft	36	59.5	40	485
	2015.05-2020.09	6DCT	F	L	MPV FWD CUUD/DFSD		2540130L	Drive Shaft	36	59.5	40.5	482
	2015.05-2020.09	6DCT	F	R	MPV FWD CUUD/DFSD		2033540L	Drive Shaft	36	59.5	40	760
	2015.05-2020.09	5MT	F	L	MPV Van FWD CUUD/DFSD		2611000L	Drive Shaft	36	59.5	40.5	514
	2015.05-2020.09	5MT	F	R	MPV Van FWD CUUD/DFSD		2613410L	Drive Shaft	36	59.5	40.5	806
	2015.05-2020.09	6DCT	F	L	MPV Van FWD CUUD/DFSD		2033810L	Drive Shaft	36	59.5	40	485
	2015.05-2020.09	6DCT	F	L	MPV Van FWD CUUD/DFSD		2540130L	Drive Shaft	36	59.5	40.5	482
	2015.05-2020.09	6DCT	F	R	MPV Van FWD CUUD/DFSD		2033540L	Drive Shaft	36	59.5	40	760
2.0 (80 kw)	2006.04-2015.05	5MT	F	L	MPV FWD BSX	Chassis no. to:2KB005000	2033730L	Drive Shaft	36	59.5	40	517
	2006.04-2015.05	5MT	F	L	MPV FWD BSX	Chassis no. from:2KB200001	2612820L	Drive Shaft	36	59.5	40	523
	2006.04-2015.05	5MT	F	L	MPV FWD BSX	Date From:2011.08	2612820L	Drive Shaft	36	59.5	40	523
	2006.04-2015.05	5MT	F	R	MPV FWD BSX	Chassis no. to:2KB005000	2610420L	Drive Shaft	36	59.5	40	814
	2006.04-2015.05	5MT	F	L	MPV Van FWD BSX	Chassis no. to:2KB005000	2033730L	Drive Shaft	36	59.5	40	517
	2006.04-2015.05	5MT	F	L	MPV Van FWD BSX	Chassis no. from:2KB200001	2612820L	Drive Shaft	36	59.5	40	523
	2006.04-2015.05	5MT	F	L	MPV Van FWD BSX	Date From:2011.08	2612820L	Drive Shaft	36	59.5	40	523
	2006.04-2015.05	5MT	F	R	MPV Van FWD BSX	Chassis no. to:2KB005000	2610420L	Drive Shaft	36	59.5	40	814
2.0 (81 kw)	2010.08-2015.05	5MT	F	L	MPV FWD CLCA		2611000L	Drive Shaft	36	59.5	40.5	514
	2010.08-2015.05	5MT	F	R	MPV FWD CLCA		2613410L	Drive Shaft	36	59.5	40.5	806
	2010.08-2015.05	MT	F	L	MPV FWD CLCA		2033800L	Drive Shaft	36	59.5	40	487
	2010.08-2015.05	6MT	F	L	MPV Van 4WD CFHF		2032950L	Drive Shaft	36	59.5	40.5	486
	2010.08-2015.05	6MT	F	R	MPV Van 4WD CFHF		2032660L	Drive Shaft	36	59.5	40.5	601
	2010.08-2015.05	MT	F	L	MPV Van 4WD CFHF		2033800L	Drive Shaft	36	59.5	40	487
	2010.08-2015.05	5MT	F	L	MPV Van FWD CLCA		2611000L	Drive Shaft	36	59.5	40.5	514
	2010.08-2015.05	5MT	F	R	MPV Van FWD CLCA		2613410L	Drive Shaft	36	59.5	40.5	806
	2010.08-2015.05		F	L	MPV Van FWD CLCA		2033800L	Drive Shaft	36	59.5	40	487
	2010.10-2015.05	6MT	F	L	MPV 4WD CFHF		2032950L	Drive Shaft	36	59.5	40.5	486
	2010.10-2015.05	6MT	F	R	MPV 4WD CFHF		2032660L	Drive Shaft	36	59.5	40.5	601



 YEAR	TRANSM.	F/R	L/R	BODY STYLE & DRIVE TYPE & ENGINE	REMARKS	GSP Ref.	 PRODUCT	 ABS	Technical Specifications					
									A	B	C	H	L	
VW														
Caddy Maxi														
2.0 (81 kw)	2010.10-2015.05		F	L	MPV 4WD CFHF		2033800L	Drive Shaft		36		59.5	40	487
2.0 (90 kw)	2020.09-	7DCT	F	L	MPV FWD DTRC		2023510L	Drive Shaft		36	37	59.5	40	570
	2020.09-	7DCT	F	R	MPV FWD DTRC		2036130L	Drive Shaft		36	37	59.5	40	921
	2020.09-	7DCT	F	L	MPV Van FWD DTRC		2023510L	Drive Shaft		36	37	59.5	40	570
	2020.09-	7DCT	F	R	MPV Van FWD DTRC		2036130L	Drive Shaft		36	37	59.5	40	921
	2020.09-	7DCT	F	R	MPV Van FWD DTRC		2036130L	Drive Shaft		36	37	59.5	40	921
2.0 (103 kw)	2007.11-2010.08	6MT	F	L	MPV FWD BMM		2033800L	Drive Shaft		36		59.5	40	487
	2007.11-2010.08	6MT	F	R	MPV FWD BMM		2033130L	Drive Shaft		36		59.5	40.5	794
	2007.11-2010.08	6MT	F	R	MPV FWD BMM		2611470L	Drive Shaft		36		59.5	40.5	795
	2007.11-2010.08	6MT	F	R	MPV Van FWD BMM		2611470L	Drive Shaft		36		59.5	40.5	795
	2007.11-2010.08		F	L	MPV Van FWD BMM		2033800L	Drive Shaft		36		59.5	40	487
	2007.11-2010.08		F	R	MPV Van FWD BMM		2033130L	Drive Shaft		36		59.5	40.5	794
	2010.11-2015.05	AT	F	R	MPV 4WD CFHC		2540110L	Drive Shaft		36		59.5	40.5	760
	2010.11-2015.05	MT	F	L	MPV 4WD CFHC		2033800L	Drive Shaft		36		59.5	40	487
	2010.11-2015.05	6DCT	F	L	MPV FWD CFHC/CLCB		2033810L	Drive Shaft		36		59.5	40	485
	2010.11-2015.05	6DCT	F	L	MPV FWD CFHC/CLCB		2540130L	Drive Shaft		36		59.5	40.5	482
	2010.11-2015.05	6DCT	F	R	MPV FWD CFHC/CLCB		2540110L	Drive Shaft		36		59.5	40.5	760
	2010.11-2015.05	6MT	F	R	MPV FWD CFHC/CLCB		2611470L	Drive Shaft		36		59.5	40.5	795
	2010.11-2015.05	MT	F	L	MPV FWD CFHC/CLCB		2033800L	Drive Shaft		36		59.5	40	487
	2010.11-2015.05		F	R	MPV FWD CFHC/CLCB		2033130L	Drive Shaft		36		59.5	40.5	794
	2010.11-2015.05	AT	F	R	MPV Van 4WD CFHC		2540110L	Drive Shaft		36		59.5	40.5	760
	2010.11-2015.05	MT	F	L	MPV Van 4WD CFHC		2033800L	Drive Shaft		36		59.5	40	487
	2010.11-2015.05	6DCT	F	L	MPV Van FWD CFHC/CLCB		2033810L	Drive Shaft		36		59.5	40	485
	2010.11-2015.05	6DCT	F	L	MPV Van FWD CFHC/CLCB		2540130L	Drive Shaft		36		59.5	40.5	482
	2010.11-2015.05	6DCT	F	R	MPV Van FWD CFHC/CLCB		2540110L	Drive Shaft		36		59.5	40.5	760
	2010.11-2015.05	6MT	F	R	MPV Van FWD CFHC/CLCB		2611470L	Drive Shaft		36		59.5	40.5	795
	2010.11-2015.05	MT	F	L	MPV Van FWD CFHC/CLCB		2033800L	Drive Shaft		36		59.5	40	487
	2010.11-2015.05		F	R	MPV Van FWD CFHC/CLCB		2033130L	Drive Shaft		36		59.5	40.5	794
	2015.05-2020.09	DCT	F	L	MPV 4WD CFHC		2540130L	Drive Shaft		36		59.5	40.5	482
	2015.05-2020.09	6DCT	F	L	MPV FWD CFHC/CLCB		2033810L	Drive Shaft		36		59.5	40	485
	2015.05-2020.09	6DCT	F	L	MPV FWD CFHC/CLCB		2540130L	Drive Shaft		36		59.5	40.5	482
	2015.05-2020.09	6DCT	F	R	MPV FWD CFHC/CLCB		2033540L	Drive Shaft		36		59.5	40	760
	2015.05-2020.09	6MT	F	L	MPV FWD CFHC/CLCB		2032950L	Drive Shaft		36		59.5	40.5	486
	2015.05-2020.09	DCT	F	L	MPV Van 4WD CFHC		2540130L	Drive Shaft		36		59.5	40.5	482
	2015.05-2020.09	6DCT	F	L	MPV Van FWD CFHC/CLCB		2033810L	Drive Shaft		36		59.5	40	485
	2015.05-2020.09	6DCT	F	L	MPV Van FWD CFHC/CLCB		2540130L	Drive Shaft		36		59.5	40.5	482
2015.05-2020.09	6DCT	F	R	MPV Van FWD CFHC/CLCB		2033540L	Drive Shaft		36		59.5	40	760	
2015.05-2020.09	6MT	F	L	MPV Van FWD CFHC/CLCB		2032950L	Drive Shaft		36		59.5	40.5	486	
2.0 (110 kw)	2015.05-2020.09	6DCT	F	L	MPV FWD CUUB/DFSB		2033810L	Drive Shaft		36		59.5	40	485
	2015.05-2020.09	6DCT	F	L	MPV FWD CUUB/DFSB		2540130L	Drive Shaft		36		59.5	40.5	482
	2015.05-2020.09	6DCT	F	R	MPV FWD CUUB/DFSB		2033540L	Drive Shaft		36		59.5	40	760
	2015.05-2020.09	6MT	F	L	MPV FWD CUUB/DFSB		2032950L	Drive Shaft		36		59.5	40.5	486
	2015.05-2020.09	6MT	F	R	MPV FWD CUUB/DFSB	Date From:2016.03	2033130L	Drive Shaft		36		59.5	40.5	794
	2015.05-2020.09	6MT	F	R	MPV FWD CUUB/DFSB	Date to:2016.02	2611470L	Drive Shaft		36		59.5	40.5	795
	2015.05-2020.09	6DCT	F	L	MPV Van FWD CUUB/DFSB		2033810L	Drive Shaft		36		59.5	40	485
	2015.05-2020.09	6DCT	F	L	MPV Van FWD CUUB/DFSB		2540130L	Drive Shaft		36		59.5	40.5	482
	2015.05-2020.09	6DCT	F	R	MPV Van FWD CUUB/DFSB		2033540L	Drive Shaft		36		59.5	40	760
	2015.05-2020.09	6MT	F	L	MPV Van FWD CUUB/DFSB		2032950L	Drive Shaft		36		59.5	40.5	486
2.0 (125 kw)	2012.05-2015.05	6AT	F	L	MPV FWD CFJA		2540130L	Drive Shaft		36		59.5	40.5	482
	2012.05-2015.05	6AT	F	R	MPV FWD CFJA		2540110L	Drive Shaft		36		59.5	40.5	760
	2012.05-2015.05	6DCT	F	L	MPV FWD CFJA		2033810L	Drive Shaft		36		59.5	40	485
	2012.05-2015.05	6AT	F	L	MPV Van FWD CFJA		2540130L	Drive Shaft		36		59.5	40.5	482
	2012.05-2015.05	6AT	F	R	MPV Van FWD CFJA		2540110L	Drive Shaft		36		59.5	40.5	760
	2012.05-2015.05	6DCT	F	L	MPV Van FWD CFJA		2033810L	Drive Shaft		36		59.5	40	485
California														
1.9 (63 kw)	2007.05-2009.11	5MT	F	L	Bus FWD AXC	6 balls	2611050L	Drive Shaft		38		63	102.5	645
1.9 (75 kw)	2007.05-2009.11	5MT	F	L	Bus FWD BRS	6 balls	2611050L	Drive Shaft		38		63	102.5	645
1.9 (77 kw)	2007.05-2009.11	5MT	F	L	Bus FWD AXB	6 balls	2611050L	Drive Shaft		38		63	102.5	645
2.0 (62 kw)	2009.09-2015.08	5MT	F	L	Bus FWD CAAA	6 balls	2611050L	Drive Shaft		38		63	102.5	645
	2009.09-2015.08	5MT	F	R	Bus FWD CAAA		2032610L	Drive Shaft		38	26	63	102.5	857
2.0 (75 kw)	2009.08-2015.08	5MT	F	L	Bus FWD CAAB	6 balls	2611050L	Drive Shaft		38		63	102.5	645
	2009.08-2015.08	5MT	F	R	Bus FWD CAAB		2032610L	Drive Shaft		38	26	63	102.5	857
2.0 (84 kw)	2011.05-2015.08	5MT	F	L	Bus FWD CAAD	6 balls	2611050L	Drive Shaft		38		63	102.5	645
	2011.05-2015.08	5MT	F	R	Bus FWD CAAD		2032610L	Drive Shaft		38	26	63	102.5	857
2.0 (100 kw)	2010.05-2015.08	6MT	F	L	Bus 4WD CAAE/CCHB	Date From:2013.07	2033600L	Drive Shaft		38	42	63	102.5	617
	2010.05-2015.08	6MT	F	L	Bus 4WD CAAE/CCHB		2610840L	Drive Shaft		38	26	63	102.5	616



	 YEAR	TRANSM.	F/R	L/R	BODY STYLE & DRIVE TYPE & ENGINE	REMARKS	GSP Ref.	 PRODUCT	 ABS	Technical Specifications					
										A	B	C	H	L	
VW California 2.0 (100 kw)	2010.05-2015.08	6MT	F	R	Bus 4WD CAAE/CCHB	Date from:2013.07	2016660L	Drive Shaft		38	26	63	102.5	616	
	2010.05-2015.08	6MT	F	R	Bus 4WD CAAE/CCHB	Date to:2013.06	2610840L	Drive Shaft		38	26	63	102.5	616	
	2010.05-2015.08	6MT	R	L	Bus 4WD CAAE/CCHB		2612570L	Drive Shaft		38		59	102	683	
	2010.05-2015.08	6MT	R	R	Bus 4WD CAAE/CCHB		2612580L	Drive Shaft		38		59	102	743	
	2010.05-2015.08	6MT	F	L	Bus FWD CAAE/CCHB	Date From:2013.07	2033600L	Drive Shaft		38	42	63	102.5	617	
	2010.05-2015.08	6MT	F	L	Bus FWD CAAE/CCHB	Date to:2013.06	2610840L	Drive Shaft		38	26	63	102.5	616	
	2010.05-2015.08	6MT	F	R	Bus FWD CAAE/CCHB	Date From:2013.07,Date To:2015.04	2023610L	Drive Shaft		38	26	63	102.5	879	
	2010.05-2015.08	6MT	F	R	Bus FWD CAAE/CCHB		2032960L	Drive Shaft		38	26	63	102.5	880	
	2010.05-2015.08	6MT	F	R	Bus FWD CAAE/CCHB	Date From:2015.05	2033610L	Drive Shaft		38	26	63	102.5	881	
	2010.05-2015.08	7DCT	F	L	Bus FWD CAAE/CCHB		2032930L	Drive Shaft		38	37	63	102.5	647	
	2010.05-2015.08	7DCT	F	R	Bus FWD CAAE/CCHB	Chassis no. from:7HC5000001/7HC4000001/7HCX000001	2023920L	Drive Shaft		38	37	63	102.5	1026	
2010.05-2015.08	7DCT	F	R	Bus FWD CAAE/CCHB	Chassis no. to:7HB5500000/7HB4500000/7HBX500000	2033530L	Drive Shaft		38	37	63	102.5	1026		
2.0 (103 kw)	2009.08-2015.08	6MT	F	L	Bus FWD CAAC/CCHA	Date From:2013.07	2033600L	Drive Shaft		38	42	63	102.5	617	
	2009.08-2015.08	6MT	F	L	Bus FWD CAAC/CCHA	Date to:2013.06	2610840L	Drive Shaft		38	26	63	102.5	616	
	2009.08-2015.08	6MT	F	R	Bus FWD CAAC/CCHA	Date From:2013.07,Date To:2015.04	2023610L	Drive Shaft		38	26	63	102.5	879	
	2009.08-2015.08	6MT	F	R	Bus FWD CAAC/CCHA		2032960L	Drive Shaft		38	26	63	102.5	880	
	2009.08-2015.08	6MT	F	R	Bus FWD CAAC/CCHA	Date From:2015.05	2033610L	Drive Shaft		38	26	63	102.5	881	
	2009.08-2015.08	7DCT	F	L	Bus FWD CAAC/CCHA		2032930L	Drive Shaft		38	37	63	102.5	647	
	2009.08-2015.08	7DCT	F	R	Bus FWD CAAC/CCHA	Chassis no. From:7HC5000001/7HC4000001/7HCX000001	2023920L	Drive Shaft		38	37	63	102.5	1026	
	2009.08-2015.08	7DCT	F	R	Bus FWD CAAC/CCHA	Chassis no. To:7HB5500000/7HB4500000/7HBX500000	2033530L	Drive Shaft		38	37	63	102.5	1026	
	2009.10-2015.08	6MT	F	L	Bus 4WD CAAC/CCHA	Date From:2013.07	2033600L	Drive Shaft		38	42	63	102.5	617	
	2009.10-2015.08	6MT	F	L	Bus 4WD CAAC/CCHA		2610840L	Drive Shaft		38	26	63	102.5	616	
	2009.10-2015.08	6MT	F	R	Bus 4WD CAAC/CCHA	Date from:2013.07	2016660L	Drive Shaft		38	26	63	102.5	616	
	2009.10-2015.08	6MT	F	R	Bus 4WD CAAC/CCHA	Date to:2013.06	2610840L	Drive Shaft		38	26	63	102.5	616	
	2009.10-2015.08	6MT	R	L	Bus 4WD CAAC/CCHA		2612570L	Drive Shaft		38		59	102	683	
	2009.10-2015.08	6MT	R	R	Bus 4WD CAAC/CCHA		2612580L	Drive Shaft		38		59	102	743	
	2015.04-2019.12	6MT	F	L	Bus FWD CAAC	Date to:2017.01	2610840L	Drive Shaft		38	26	63	102.5	616	
	2015.06-2019.12	6MT	F	L	Bus 4WD CAAC	Date to:2017.01	2610840L	Drive Shaft		38	26	63	102.5	616	
	2015.06-2019.12	6MT	F	R	Bus 4WD CAAC	Date to:2017.01	2016660L	Drive Shaft		38	26	63	102.5	616	
2015.06-2019.12	6MT	R	L	Bus 4WD CAAC		2612570L	Drive Shaft		38		59	102	683		
2015.06-2019.12	6MT	R	R	Bus 4WD CAAC	Date To:2016.04	2612580L	Drive Shaft		38		59	102	743		
2.0 (110 kw)	2012.07-2015.08	6MT	F	L	Bus FWD CJKB	Date From:2013.07	2033600L	Drive Shaft		38	42	63	102.5	617	
	2012.07-2015.08	6MT	F	L	Bus FWD CJKB	Date to:2013.06	2610840L	Drive Shaft		38	26	63	102.5	616	
	2012.07-2015.08	6MT	F	L	Bus FWD CJKB		2610840L	Drive Shaft		38	26	63	102.5	616	
	2012.07-2015.08	6MT	F	R	Bus FWD CJKB	Date From:2013.07,Date To:2015.04	2023610L	Drive Shaft		38	26	63	102.5	879	
	2012.07-2015.08	6MT	F	R	Bus FWD CJKB	Date To:2013.06	2032960L	Drive Shaft		38	26	63	102.5	880	
	2012.07-2015.08	6MT	F	R	Bus FWD CJKB	Date From:2015.05	2033610L	Drive Shaft		38	26	63	102.5	881	
	2015.04-	6MT	F	L	Bus FWD CXFA/CXHA/DNAA	Date To:2017.01	2033600L	Drive Shaft		38	42	63	102.5	617	
	2015.04-	6MT	F	R	Bus FWD CXFA/CXHA/DNAA	Date To:2017.01	2033610L	Drive Shaft		38	26	63	102.5	881	
	2015.04-	7DCT	F	L	Bus FWD CXFA/CXHA/DNAA		2032930L	Drive Shaft		38	37	63	102.5	647	
	2015.04-	7DCT	F	R	Bus FWD CXFA/CXHA/DNAA		2023920L	Drive Shaft		38	37	63	102.5	1026	
	2015.04-2019.07	6MT	F	L	Bus FWD CJKB	Date to:2017.01	2610840L	Drive Shaft		38	26	63	102.5	616	
	2015.08-	6MT	F	L	Bus 4WD CXFA/CXHA/DNAA	Date To:2017.01-Outer teeth of transm.side-4:2	2033600L	Drive Shaft		38	42	63	102.5	617	
	2015.08-	6MT	F	R	Bus 4WD CXFA/CXHA/DNAA	Date to:2017.01-Model code:5GB8G;Date to:2017.01-Model code:5GC5G	2016660L	Drive Shaft		38	26	63	102.5	616	
	2015.08-	7DCT	F	L	Bus 4WD CXFA/CXHA/DNAA		2032930L	Drive Shaft		38	37	63	102.5	647	
	2015.08-	7DCT	F	R	Bus 4WD CXFA/CXHA/DNAA		2016650L	Drive Shaft		38	26	63	102.5	614	
	2015.08-	6MT/7DCT	R	L	Bus 4WD CXFA/CXHA/DNAA		2612570L	Drive Shaft		38		59	102	683	
	2015.08-	6MT/7DCT	R	R	Bus 4WD CXFA/CXHA/DNAA	Date to:2016.04	2612580L	Drive Shaft		38		59	102	743	
	2.0 (132 kw)	2009.09-2015.08	6MT	F	L	Bus FWD CFCA	Date From:2013.07	2033600L	Drive Shaft		38	42	63	102.5	617
		2009.09-2015.08	6MT	F	L	Bus FWD CFCA	Date to:2013.06	2610840L	Drive Shaft		38	26	63	102.5	616
2009.09-2015.08		6MT	F	R	Bus FWD CFCA	Date From:2013.07,Date To:2015.04	2023610L	Drive Shaft		38	26	63	102.5	879	
2009.09-2015.08		6MT	F	R	Bus FWD CFCA		2032960L	Drive Shaft		38	26	63	102.5	880	
2009.09-2015.08		6MT	F	R	Bus FWD CFCA	Date From:2015.05	2033610L	Drive Shaft		38	26	63	102.5	881	
2009.09-2015.08		7DCT	F	L	Bus FWD CFCA		2032930L	Drive Shaft		38	37	63	102.5	647	
2009.09-2015.08		7DCT	F	R	Bus FWD CFCA	Chassis no. From:7HC5000001/7HC4000001/7HCX000001	2023920L	Drive Shaft		38	37	63	102.5	1026	
2009.09-2015.08		7DCT	F	R	Bus FWD CFCA	Chassis no. To:7HB5500000/7HB4500000/7HBX500000	2033530L	Drive Shaft		38	37	63	102.5	1026	
2010.01-2015.08		6MT	F	L	Bus 4WD CFCA	Date From:2013.07	2033600L	Drive Shaft		38	42	63	102.5	617	
2010.01-2015.08		6MT	F	L	Bus 4WD CFCA		2610840L	Drive Shaft		38	26	63	102.5	616	
2010.01-2015.08		6MT	F	R	Bus 4WD CFCA	Date from:2013.07	2016660L	Drive Shaft		38	26	63	102.5	616	
2010.01-2015.08		6MT	F	R	Bus 4WD CFCA	Date to:2013.06	2610840L	Drive Shaft		38	26	63	102.5	616	
2010.01-2015.08		7DCT	F	L	Bus 4WD CFCA		2032930L	Drive Shaft		38	37	63	102.5	647	
2010.01-2015.08		7DCT	F	R	Bus 4WD CFCA	Chassis no. From:7HC5000001/7HC4000001/7HCX000001	2016650L	Drive Shaft		38	26	63	102.5	614	
2010.01-2015.08		6MT/7DCT	R	L	Bus 4WD CFCA		2612570L	Drive Shaft		38		59	102	683	
2010.01-2015.08		6MT/7DCT	R	R	Bus 4WD CFCA		2612580L	Drive Shaft		38		59	102	743	
2015.06-2019.12		7DCT	R	L	Bus 4WD CFCA		2612570L	Drive Shaft		38		59	102	683	



 YEAR	TRANSM.	F/R	L/R	BODY STYLE & DRIVE TYPE & ENGINE	REMARKS	GSP Ref.	 PRODUCT	 ABS	Technical Specifications					
									A	B	C	H	L	
VW California														
2.0 (132 kw)	2015.06-2019.12	7DCT	R	R	Bus 4WD CFCA	Date To:2016.04	2612580L	Drive Shaft		38		59	102	743
2.0 (146 kw)	2018.08-	7DCT	F	L	Bus 4WD CXEC	Date To:2020.11	2034970L	Drive Shaft		38	37	63	103	646
	2018.08-	7DCT	R	L	Bus 4WD CXEC		2612570L	Drive Shaft		38		59	102	683
	2018.08-	7DCT	F	L	Bus FWD CXEC	Date To:2020.11	2034970L	Drive Shaft		38	37	63	103	646
	2018.08-	7DCT	F	R	Bus FWD CXEC	For Modelcode:SGC/SGG	2034960L	Drive Shaft		38	37	63	103	1025
2.0 (150 kw)	2011.05-2015.08	6MT	F	L	Bus FWD CJKA	Date From:2013.07	2033600L	Drive Shaft		38	42	63	102.5	617
	2011.05-2015.08	6MT	F	L	Bus FWD CJKA	Date to:2013.06	2610840L	Drive Shaft		38	26	63	102.5	616
	2011.05-2015.08	6MT	F	R	Bus FWD CJKA	Date From:2013.07,Date To:2015.04	20323610L	Drive Shaft		38	26	63	102.5	879
	2011.05-2015.08	6MT	F	R	Bus FWD CJKA	Date To:2013.06	2032960L	Drive Shaft		38	26	63	102.5	880
	2011.05-2015.08	6MT	F	R	Bus FWD CJKA	Date From:2015.05	2033610L	Drive Shaft		38	26	63	102.5	881
	2011.05-2015.08	7DCT	F	L	Bus FWD CJKA		2032930L	Drive Shaft		38	37	63	102.5	647
	2011.05-2015.08	7DCT	F	R	Bus FWD CJKA	Chassis no. from:7HC000001/7HC00001/7HC00001	2032920L	Drive Shaft		38	37	63	102.5	1026
	2011.05-2015.08	7DCT	F	R	Bus FWD CJKA	Chassis no. to:7HB0500000/7HB050000/7HBX00000	2033530L	Drive Shaft		38	37	63	102.5	1026
	2011.07-2015.08	7DCT	F	L	Bus 4WD CJKA		2032930L	Drive Shaft		38	37	63	102.5	647
	2011.07-2015.08	7DCT	F	R	Bus 4WD CJKA		2016650L	Drive Shaft		38	26	63	102.5	614
	2011.07-2015.08	7DCT	R	L	Bus 4WD CJKA		2612570L	Drive Shaft		38		59	102	683
	2011.07-2015.08	7DCT	R	R	Bus 4WD CJKA		2612580L	Drive Shaft		38		59	102	743
	2015.06-	7DCT	F	L	Bus 4WD CXEB/DMZA	Date From:2017.01,Date To:2020.11	2034970L	Drive Shaft		38	37	63	103	646
	2015.06-	6MT/7DCT	R	L	Bus 4WD CXEB/DMZA		2612570L	Drive Shaft		38		59	102	683
	2015.06-	6MT/7DCT	R	R	Bus 4WD CXEB/DMZA	Date To:2016.04	2612580L	Drive Shaft		38		59	102	743
	2015.06-	7DCT	F	L	Bus FWD CXEB/DMZA	Date From:2017.02,Date To:2020.11	2034970L	Drive Shaft		38	37	63	103	646
	2015.06-	7DCT	F	R	Bus FWD CXEB/DMZA	For Modelcode:SGC/SGG	2034960L	Drive Shaft		38	37	63	103	1025
	2015.06-2019.07	7DCT	R	L	Bus 4WD CJKA		2612570L	Drive Shaft		38		59	102	683
	2015.06-2019.07	7DCT	R	R	Bus 4WD CJKA	Date To:2016.04	2612580L	Drive Shaft		38		59	102	743
	2.5 (96 kw)	2007.05-2009.11	6MT	F	L	Bus 4WD AXD/BNZ		2610840L	Drive Shaft		38	26	63	102.5
2007.05-2009.11		6MT	R	L	Bus 4WD AXD/BNZ		2612570L	Drive Shaft		38		59	102	683
2007.05-2009.11		6MT	R	R	Bus 4WD AXD/BNZ		2612580L	Drive Shaft		38		59	102	743
2007.05-2009.11		6MT	F	L	Bus FWD AXD/BNZ		2033600L	Drive Shaft		38	42	63	102.5	617
2007.05-2009.11		6MT	F	L	Bus FWD AXD/BNZ		2610840L	Drive Shaft		38	26	63	102.5	616
2.5 (120 kw)	2007.05-2009.11	6MT	F	L	Bus FWD BLJ		2610840L	Drive Shaft		38	26	63	102.5	616
2.5 (128 kw)	2007.05-2009.11	6MT	F	L	Bus 4WD AXE/BPC		2610840L	Drive Shaft		38	26	63	102.5	616
	2007.05-2009.11	6MT	R	L	Bus 4WD AXE/BPC		2612570L	Drive Shaft		38		59	102	683
	2007.05-2009.11	6MT	R	R	Bus 4WD AXE/BPC		2612580L	Drive Shaft		38		59	102	743
	2007.05-2009.11	6MT	F	L	Bus FWD AXE/BPC		2033600L	Drive Shaft		38	42	63	102.5	617
	2007.05-2009.11	6MT	F	L	Bus FWD AXE/BPC		2610840L	Drive Shaft		38	26	63	102.5	616
Campmobile														
2.0 (75 kw)	2009.08-2015.08	5MT	F	L	Bus FWD CAAB	6 balls	2611050L	Drive Shaft		38		63	102.5	645
	2009.08-2015.08	5MT	F	R	Bus FWD CAAB		2032610L	Drive Shaft		38	26	63	102.5	857
2.0 (84 kw)	2011.05-2015.08	5MT	F	L	Bus FWD CAAD	6 balls	2611050L	Drive Shaft		38		63	102.5	645
	2011.05-2015.08	5MT	F	R	Bus FWD CAAD		2032610L	Drive Shaft		38	26	63	102.5	857
2.0 (100 kw)	2010.05-2015.08	6MT	F	L	Bus 4WD CCHB	Date From:2013.07	2033600L	Drive Shaft		38	42	63	102.5	617
	2010.05-2015.08	6MT	F	R	Bus 4WD CCHB	Date from:2013.07	2016660L	Drive Shaft		38	26	63	102.5	616
	2010.05-2015.08	6MT	R	L	Bus 4WD CCHB		2612570L	Drive Shaft		38		59	102	683
	2010.05-2015.08	6MT	R	R	Bus 4WD CCHB		2612580L	Drive Shaft		38		59	102	743
	2010.05-2015.08	6MT	F	L	Bus FWD CAAE/CCHB	Date From:2013.07	2033600L	Drive Shaft		38	42	63	102.5	617
	2010.05-2015.08	6MT	F	L	Bus FWD CAAE/CCHB	Date to:2013.06	2610840L	Drive Shaft		38	26	63	102.5	616
	2010.05-2015.08	6MT	F	R	Bus FWD CAAE/CCHB	Date From:2013.07,Date To:2015.04	20323610L	Drive Shaft		38	26	63	102.5	879
	2010.05-2015.08	6MT	F	R	Bus FWD CAAE/CCHB	Date To:2013.06	2032960L	Drive Shaft		38	26	63	102.5	880
	2010.05-2015.08	6MT	F	R	Bus FWD CAAE/CCHB	Date From:2015.05	2033610L	Drive Shaft		38	26	63	102.5	881
	2010.05-2015.08	7DCT	F	L	Bus FWD CAAE/CCHB		2032930L	Drive Shaft		38	37	63	102.5	647
	2010.05-2015.08	7DCT	F	R	Bus FWD CAAE/CCHB	Date From:2013.07	2032920L	Drive Shaft		38	37	63	102.5	1026
	2010.05-2015.08	7DCT	F	R	Bus FWD CAAE/CCHB	Date To:2013.06	2033530L	Drive Shaft		38	37	63	102.5	1026
	2.0 (103 kw)	2009.08-2015.08	6MT	F	L	Bus FWD CAAC/CCHA	Date From:2013.07	2033600L	Drive Shaft		38	42	63	102.5
2009.08-2015.08		6MT	F	L	Bus FWD CAAC/CCHA	Date to:2013.06	2610840L	Drive Shaft		38	26	63	102.5	616
2009.08-2015.08		6MT	F	R	Bus FWD CAAC/CCHA	Date From:2013.07,Date To:2015.04	20323610L	Drive Shaft		38	26	63	102.5	879
2009.08-2015.08		6MT	F	R	Bus FWD CAAC/CCHA	Date To:2013.06	2032960L	Drive Shaft		38	26	63	102.5	880
2009.08-2015.08		6MT	F	R	Bus FWD CAAC/CCHA	Date From:2015.05	2033610L	Drive Shaft		38	26	63	102.5	881
2009.08-2015.08		7DCT	F	L	Bus FWD CAAC/CCHA		2032930L	Drive Shaft		38	37	63	102.5	647
2009.08-2015.08		7DCT	F	R	Bus FWD CAAC/CCHA	Chassis no. From:7HC000001/7HC00001/7HC00001	2032920L	Drive Shaft		38	37	63	102.5	1026
2009.08-2015.08		7DCT	F	R	Bus FWD CAAC/CCHA	Chassis no. To:7HB0500000/7HB050000/7HBX00000	2033530L	Drive Shaft		38	37	63	102.5	1026
2009.10-2015.08		6MT	F	L	Bus 4WD CAAC/CCHA	Date From:2013.07	2033600L	Drive Shaft		38	42	63	102.5	617
2009.10-2015.08		6MT	F	R	Bus 4WD CAAC/CCHA	Date from:2013.07	2016660L	Drive Shaft		38	26	63	102.5	616
2009.10-2015.08		6MT	R	L	Bus 4WD CAAC/CCHA		2612570L	Drive Shaft		38		59	102	683
2009.10-2015.08		6MT	R	R	Bus 4WD CAAC/CCHA		2612580L	Drive Shaft		38		59	102	743
2015.04-2019.12		6MT	F	L	Bus FWD CAAC	Date to:2017.01	2610840L	Drive Shaft		38	26	63	102.5	616



	 YEAR	TRANSM.	F/R	L/R	BODY STYLE & DRIVE TYPE & ENGINE	REMARKS	GSP Ref.	 PRODUCT ABS	Technical Specifications						
									A	B	C	H	L		
VW															
Campmobile															
2.0 (103 kw)	2015.06-2019.12	6MT	F	L	Bus 4WD CAAC	Date to:2017.01	2610840L	Drive Shaft	38	26	63	102.5	616		
	2015.06-2019.12	6MT	F	R	Bus 4WD CAAC	Date to:2017.01	2016660L	Drive Shaft	38	26	63	102.5	616		
	2015.06-2019.12	6MT	R	L	Bus 4WD CAAC		2612570L	Drive Shaft	38		59	102	683		
	2015.06-2019.12	6MT	R	R	Bus 4WD CAAC	Date To:2016.04	2612580L	Drive Shaft	38		59	102	743		
2.0 (110 kw)	2012.07-2015.08	6MT	F	L	Bus FWD CJKB	Date From:2013.07	2033600L	Drive Shaft	38	42	63	102.5	617		
	2012.07-2015.08	6MT	F	L	Bus FWD CJKB		2610840L	Drive Shaft	38	26	63	102.5	616		
	2012.07-2015.08	6MT	F	L	Bus FWD CJKB	Date to:2013.06	2610840L	Drive Shaft	38	26	63	102.5	616		
	2012.07-2015.08	6MT	F	R	Bus FWD CJKB	Date From:2013.07,Date To:2015.04	2023610L	Drive Shaft	38	26	63	102.5	879		
	2012.07-2015.08	6MT	F	R	Bus FWD CJKB	Date To:2013.06	2032960L	Drive Shaft	38	26	63	102.5	880		
	2012.07-2015.08	6MT	F	R	Bus FWD CJKB	Date From:2015.05	2033610L	Drive Shaft	38	26	63	102.5	881		
	2015.04-2019.07	6MT	F	L	Bus FWD CJKB	Date to:2017.01	2610840L	Drive Shaft	38	26	63	102.5	616		
	2015.04-2019.12	6MT	F	L	Bus FWD CXFA/CXHA	Date to:2017.01	2610840L	Drive Shaft	38	26	63	102.5	616		
	2015.08-2019.12	6MT	F	L	Bus 4WD CXFA/CXHA	Date to:2017.01	2610840L	Drive Shaft	38	26	63	102.5	616		
	2015.08-2019.12	6MT	F	R	Bus 4WD CXFA/CXHA	Date to:2017.01	2016660L	Drive Shaft	38	26	63	102.5	616		
	2015.08-2019.12	6MT/7DCT	R	L	Bus 4WD CXFA/CXHA		2612570L	Drive Shaft	38		59	102	683		
	2015.08-2019.12	6MT/7DCT	R	R	Bus 4WD CXFA/CXHA	Date To:2016.04	2612580L	Drive Shaft	38		59	102	743		
2.0 (132 kw)	2009.09-2015.08	6MT	F	L	Bus FWD CFCA	Date From:2013.07	2033600L	Drive Shaft	38	42	63	102.5	617		
	2009.09-2015.08	6MT	F	L	Bus FWD CFCA	Date to:2013.06	2610840L	Drive Shaft	38	26	63	102.5	616		
	2009.09-2015.08	6MT	F	R	Bus FWD CFCA	Date From:2013.07,Date To:2015.04	2023610L	Drive Shaft	38	26	63	102.5	879		
	2009.09-2015.08	6MT	F	R	Bus FWD CFCA	Date To:2013.06	2032960L	Drive Shaft	38	26	63	102.5	880		
	2009.09-2015.08	6MT	F	R	Bus FWD CFCA	Date From:2015.05	2033610L	Drive Shaft	38	26	63	102.5	881		
	2009.09-2015.08	7DCT	F	L	Bus FWD CFCA		2032930L	Drive Shaft	38	37	63	102.5	647		
	2009.09-2015.08	7DCT	F	R	Bus FWD CFCA	Chassis no. From:7HC000001/7HC400001/7HC800001	2023920L	Drive Shaft	38	37	63	102.5	1026		
	2009.09-2015.08	7DCT	F	R	Bus FWD CFCA	Chassis no. To:7HB500000/7HB400000/7HBX500000	2033530L	Drive Shaft	38	37	63	102.5	1026		
	2010.01-2015.08	6MT	F	L	Bus 4WD CFCA	Date From:2013.07	2033600L	Drive Shaft	38	42	63	102.5	617		
	2010.01-2015.08	6MT	F	R	Bus 4WD CFCA	Date from:2013.07	2016660L	Drive Shaft	38	26	63	102.5	616		
	2010.01-2015.08	7DCT	F	L	Bus 4WD CFCA		2032930L	Drive Shaft	38	37	63	102.5	647		
	2010.01-2015.08	7DCT	F	R	Bus 4WD CFCA	Date From:2013.07	2016650L	Drive Shaft	38	26	63	102.5	614		
	2010.01-2015.08	6MT/7DCT	R	L	Bus 4WD CFCA		2612570L	Drive Shaft	38		59	102	683		
	2010.01-2015.08	6MT/7DCT	R	R	Bus 4WD CFCA		2612580L	Drive Shaft	38		59	102	743		
2.0 (150 kw)	2011.05-2015.08	6MT	F	L	Bus FWD CJKA	Date From:2013.07	2033600L	Drive Shaft	38	42	63	102.5	617		
	2011.05-2015.08	6MT	F	L	Bus FWD CJKA	Date to:2013.06	2610840L	Drive Shaft	38	26	63	102.5	616		
	2011.05-2015.08	6MT	F	R	Bus FWD CJKA	Date From:2013.07,Date To:2015.04	2023610L	Drive Shaft	38	26	63	102.5	879		
	2011.05-2015.08	6MT	F	R	Bus FWD CJKA	Date To:2013.06	2032960L	Drive Shaft	38	26	63	102.5	880		
	2011.05-2015.08	6MT	F	R	Bus FWD CJKA	Date From:2015.05	2033610L	Drive Shaft	38	26	63	102.5	881		
	2011.05-2015.08	7DCT	F	L	Bus FWD CJKA		2032930L	Drive Shaft	38	37	63	102.5	647		
	2011.05-2015.08	7DCT	F	R	Bus FWD CJKA	Date From:2013.07	2023920L	Drive Shaft	38	37	63	102.5	1026		
	2011.05-2015.08	7DCT	F	R	Bus FWD CJKA	Date To:2013.06	2033530L	Drive Shaft	38	37	63	102.5	1026		
	2011.07-2015.08	7DCT	F	L	Bus 4WD CJKA		2032930L	Drive Shaft	38	37	63	102.5	647		
	2011.07-2015.08	7DCT	F	R	Bus 4WD CJKA		2016650L	Drive Shaft	38	26	63	102.5	614		
	2011.07-2015.08	7DCT	R	L	Bus 4WD CJKA		2612570L	Drive Shaft	38		59	102	683		
	2011.07-2015.08	7DCT	R	R	Bus 4WD CJKA		2612580L	Drive Shaft	38		59	102	743		
	2015.06-2019.07	7DCT	R	L	Bus 4WD CJKA		2612570L	Drive Shaft	38		59	102	683		
	2015.06-2019.07	7DCT	R	R	Bus 4WD CJKA	Date To:2016.04	2612580L	Drive Shaft	38		59	102	743		
	2015.06-2019.12	7DCT	F	L	Bus 4WD CXEB	Date From:2017.02	2034970L	Drive Shaft	38	37	63	103	646		
	2015.06-2019.12	6MT/7DCT	R	L	Bus 4WD CXEB		2612570L	Drive Shaft	38		59	102	683		
	2015.06-2019.12	6MT/7DCT	R	R	Bus 4WD CXEB	Date To:2016.04	2612580L	Drive Shaft	38		59	102	743		
	2015.06-2019.12	7DCT	F	L	Bus FWD CXEB	Date From:2017.02	2034970L	Drive Shaft	38	37	63	103	646		
	2015.06-2019.12	7DCT	F	R	Bus FWD CXEB		2034960L	Drive Shaft	38	37	63	103	1025		
2.5 (96 kw)	2004.03-2009.11	6MT	F	L	Bus 4WD AXD/BNZ		2610840L	Drive Shaft	38	26	63	102.5	616		
	2004.03-2009.11	6MT	R	L	Bus 4WD AXD/BNZ		2612570L	Drive Shaft	38		59	102	683		
	2004.03-2009.11	6MT	R	R	Bus 4WD AXD/BNZ		2612580L	Drive Shaft	38		59	102	743		
	2004.03-2009.11	6MT	F	L	Bus FWD AXD/BNZ		2610840L	Drive Shaft	38	26	63	102.5	616		
2.5 (128 kw)	2004.03-2009.11	6MT	F	L	Bus 4WD AXE/BPC		2610840L	Drive Shaft	38	26	63	102.5	616		
	2004.03-2009.11	6MT	R	L	Bus 4WD AXE/BPC		2612570L	Drive Shaft	38		59	102	683		
	2004.03-2009.11	6MT	R	R	Bus 4WD AXE/BPC		2612580L	Drive Shaft	38		59	102	743		
	2004.03-2009.11	6MT	F	L	Bus FWD AXE/BPC		2610840L	Drive Shaft	38	26	63	102.5	616		
Caravelle															
1.9 (62 kw)	2006.01-2009.11	5MT	F	L	Bus FWD BRR	6 balls	2611050L	Drive Shaft	38		63	102.5	645		
1.9 (63 kw)	2003.04-2009.11	5MT	F	L	Bus FWD AXC	6 balls	2611050L	Drive Shaft	38		63	102.5	645		
1.9 (75 kw)	2006.01-2009.11	5MT	F	L	Bus FWD BRS	6 balls	2611050L	Drive Shaft	38		63	102.5	645		
1.9 (77 kw)	2003.04-2009.11	5MT	F	L	Bus FWD AXB	6 balls	2611050L	Drive Shaft	38		63	102.5	645		
2.0 (62 kw)	2009.09-2015.11	5MT	F	L	Bus FWD CAAA	6 balls	2611050L	Drive Shaft	38		63	102.5	645		
	2009.09-2015.11	5MT	F	R	Bus FWD CAAA		2032610L	Drive Shaft	38	26	63	102.5	857		
	2015.04-	5MT	F	L	Bus FWD CAAA/CXGA	Date To:2017.03	2611050L	Drive Shaft	38		63	102.5	645		



 YEAR	TRANSM.	F/R	L/R	BODY STYLE & DRIVE TYPE & ENGINE	REMARKS	GSP Ref.	 PRODUCT	 ABS	Technical Specifications						
									A	B	C	H	L		
VW															
Caravelle															
2.0 (62 kw)	2015.04-	5MT	F	R	Bus FWD CAAA/CXGA	Date To:2017.03	2032610L	Drive Shaft		38	26	63	102.5	857	
2.0 (75 kw)	2009.09-2015.11	5MT	F	L	Bus FWD CAAB	6 balls	2611050L	Drive Shaft		38		63	102.5	645	
	2009.09-2015.11	5MT	F	R	Bus FWD CAAB		2032610L	Drive Shaft		38	26	63	102.5	857	
	2015.04-	5MT	F	L	Bus FWD CAAB/CXGB	Date To:2017.03	2611050L	Drive Shaft		38		63	102.5	645	
	2015.04-	5MT	F	R	Bus FWD CAAB/CXGB	Date To:2017.03	2032610L	Drive Shaft		38	26	63	102.5	857	
	2011.05-2015.11	5MT	F	L	Bus FWD CAAD	6 balls	2611050L	Drive Shaft		38		63	102.5	645	
2.0 (84 kw)	2011.05-2015.11	5MT	F	R	Bus FWD CAAD		2032610L	Drive Shaft		38	26	63	102.5	857	
	2016.05-	5MT	F	L	Bus FWD CXHB	Date To:2017.03	2611050L	Drive Shaft		38		63	102.5	645	
	2003.11-2015.11	5MT	F	L	Bus FWD AXA	6 balls	2611050L	Drive Shaft		38		63	102.5	645	
2.0 (85 kw)	2006.01-2014.03	5MT	F	L	Bus FWD AXACNG	6 balls	2611050L	Drive Shaft		38		63	102.5	645	
	2011.05-2015.08	MT	F	L	Bus FWD CSDA	Date To:2013.05;6 balls	2611050L	Drive Shaft		38		63	102.5	645	
	2011.05-2015.08	MT	F	R	Bus FWD CSDA	Date To:2012.08	2032610L	Drive Shaft		38	26	63	102.5	857	
	2010.05-2015.11	6MT	F	L	Bus 4WD CAAE/CCHB	Date From:2013.07	2033600L	Drive Shaft		38	42	63	102.5	617	
2.0 (100 kw)	2010.05-2015.11	6MT	F	L	Bus 4WD CAAE/CCHB		2610840L	Drive Shaft		38	26	63	102.5	616	
	2010.05-2015.11	6MT	F	R	Bus 4WD CAAE/CCHB	Date from:2013.07	2016660L	Drive Shaft		38	26	63	102.5	616	
	2010.05-2015.11	6MT	F	R	Bus 4WD CAAE/CCHB	Date to:2013.06	2610840L	Drive Shaft		38	26	63	102.5	616	
	2010.05-2015.11	6MT	R	L	Bus 4WD CAAE/CCHB		2612570L	Drive Shaft		38		59	102	683	
	2010.05-2015.11	6MT	R	R	Bus 4WD CAAE/CCHB		2612580L	Drive Shaft		38		59	102	743	
	2010.05-2015.11	6MT	F	L	Bus FWD CAAE/CCHB	Date From:2013.07	2033600L	Drive Shaft		38	42	63	102.5	617	
	2010.05-2015.11	6MT	F	L	Bus FWD CAAE/CCHB	Date to:2013.06	2610840L	Drive Shaft		38	26	63	102.5	616	
	2010.05-2015.11	6MT	F	R	Bus FWD CAAE/CCHB	Date From:2013.07;Date To:2015.04	2023610L	Drive Shaft		38	26	63	102.5	879	
	2010.05-2015.11	6MT	F	R	Bus FWD CAAE/CCHB		2032960L	Drive Shaft		38	26	63	102.5	880	
	2010.05-2015.11	6MT	F	R	Bus FWD CAAE/CCHB	Date From:2015.05	2033610L	Drive Shaft		38	26	63	102.5	881	
	2010.05-2015.11	7DCT	F	L	Bus FWD CAAE/CCHB		2032930L	Drive Shaft		38	37	63	102.5	647	
	2010.05-2015.11	7DCT	F	R	Bus FWD CAAE/CCHB	Chassis no. from:7HC0500001/7HC400001/7HCX00001	2023920L	Drive Shaft		38	37	63	102.5	1026	
	2010.05-2015.11	7DCT	F	R	Bus FWD CAAE/CCHB	Chassis no. to:7HB5500000/7HB4500000/7HBX500000	2033530L	Drive Shaft		38	37	63	102.5	1026	
	2.0 (103 kw)	2009.09-2015.11	6MT	F	L	Bus 4WD CAAC/CCHA	Date From:2013.07	2033600L	Drive Shaft		38	42	63	102.5	617
		2009.09-2015.11	6MT	F	L	Bus 4WD CAAC/CCHA		2610840L	Drive Shaft		38	26	63	102.5	616
2009.09-2015.11		6MT	F	R	Bus 4WD CAAC/CCHA	Date from:2013.07	2016660L	Drive Shaft		38	26	63	102.5	616	
2009.09-2015.11		6MT	F	R	Bus 4WD CAAC/CCHA	Date to:2013.06	2610840L	Drive Shaft		38	26	63	102.5	616	
2009.09-2015.11		6MT	R	L	Bus 4WD CAAC/CCHA		2612570L	Drive Shaft		38		59	102	683	
2009.09-2015.11		6MT	R	R	Bus 4WD CAAC/CCHA		2612580L	Drive Shaft		38		59	102	743	
2009.09-2015.11		6MT	F	L	Bus FWD CAAC/CCHA	Date From:2013.07	2033600L	Drive Shaft		38	42	63	102.5	617	
2009.09-2015.11		6MT	F	L	Bus FWD CAAC/CCHA	Date to:2013.06	2610840L	Drive Shaft		38	26	63	102.5	616	
2009.09-2015.11		6MT	F	R	Bus FWD CAAC/CCHA	Date From:2013.07;Date To:2015.04	2023610L	Drive Shaft		38	26	63	102.5	879	
2009.09-2015.11		6MT	F	R	Bus FWD CAAC/CCHA		2032960L	Drive Shaft		38	26	63	102.5	880	
2009.09-2015.11		6MT	F	R	Bus FWD CAAC/CCHA	Date From:2015.05	2033610L	Drive Shaft		38	26	63	102.5	881	
2009.09-2015.11		7DCT	F	L	Bus FWD CAAC/CCHA		2032930L	Drive Shaft		38	37	63	102.5	647	
2009.09-2015.11		7DCT	F	R	Bus FWD CAAC/CCHA	Chassis no. From:7HC0500001/7HC400001/7HCX00001	2023920L	Drive Shaft		38	37	63	102.5	1026	
2009.09-2015.11		7DCT	F	R	Bus FWD CAAC/CCHA	Chassis no. To:7HB5500000/7HB4500000/7HBX500000	2033530L	Drive Shaft		38	37	63	102.5	1026	
2015.04-		6MT	F	L	Bus FWD CAAC		2033600L	Drive Shaft		38	42	63	102.5	617	
2015.04-		6MT	F	L	Bus FWD CAAC	Date to:2017.01	2610840L	Drive Shaft		38	26	63	102.5	616	
2015.04-		6MT	F	R	Bus FWD CAAC		2033610L	Drive Shaft		38	26	63	102.5	881	
2015.04-		7DCT	F	L	Bus FWD CAAC		2032930L	Drive Shaft		38	37	63	102.5	647	
2015.04-		7DCT	F	R	Bus FWD CAAC	8 balls	2023920L	Drive Shaft		38	37	63	102.5	1026	
2015.04-		7DCT	F	R	Bus FWD CAAC	Date to:2017.01	2033530L	Drive Shaft		38	37	63	102.5	1026	
2015.06-		6MT	F	L	Bus 4WD CAAC	Date To:2017.01	2033600L	Drive Shaft		38	42	63	102.5	617	
2015.06-		6MT	F	L	Bus 4WD CAAC	Date to:2017.01	2610840L	Drive Shaft		38	26	63	102.5	616	
2015.06-		6MT	F	R	Bus 4WD CAAC	Date to:2017.01	2016660L	Drive Shaft		38	26	63	102.5	616	
2015.06-		AT	F	L	Bus 4WD CAAC		2032930L	Drive Shaft		38	37	63	102.5	647	
2015.06-		6MT	R	L	Bus 4WD CAAC		2612570L	Drive Shaft		38		59	102	683	
2015.06-		6MT	R	R	Bus 4WD CAAC	Date To:2016.04	2612580L	Drive Shaft		38		59	102	743	
2.0 (110 kw)		2012.07-2015.11	6MT	F	L	Bus FWD CJKB	Date From:2013.07	2033600L	Drive Shaft		38	42	63	102.5	617
		2012.07-2015.11	6MT	F	L	Bus FWD CJKB	Date to:2013.06	2610840L	Drive Shaft		38	26	63	102.5	616
		2012.07-2015.11	6MT	F	R	Bus FWD CJKB	Date From:2013.07;Date To:2015.04	2023610L	Drive Shaft		38	26	63	102.5	879
		2012.07-2015.11	6MT	F	R	Bus FWD CJKB	Date To:2013.06	2032960L	Drive Shaft		38	26	63	102.5	880
	2012.07-2015.11	6MT	F	R	Bus FWD CJKB	Date From:2015.05	2033610L	Drive Shaft		38	26	63	102.5	881	
	2015.04-	6MT	F	L	Bus FWD CJKB	Date From:2013.06	2033600L	Drive Shaft		38	42	63	102.5	617	
	2015.04-	6MT	F	L	Bus FWD CJKB	Date to:2017.01	2610840L	Drive Shaft		38	26	63	102.5	616	
	2015.04-	6MT	F	R	Bus FWD CJKB	Date From:2012.05	2033610L	Drive Shaft		38	26	63	102.5	881	
	2015.04-	7AT	F	L	Bus FWD CJKB		2032930L	Drive Shaft		38	37	63	102.5	647	
	2015.04-	6MT	F	L	Bus FWD CXFA/CXHA/DNAA	Date To:2017.01	2033600L	Drive Shaft		38	42	63	102.5	617	
	2015.04-	6MT	F	R	Bus FWD CXFA/CXHA/DNAA	Date To:2017.01	2033610L	Drive Shaft		38	26	63	102.5	881	
	2015.04-	7DCT	F	L	Bus FWD CXFA/CXHA/DNAA		2032930L	Drive Shaft		38	37	63	102.5	647	
	2015.04-	7DCT	F	R	Bus FWD CXFA/CXHA/DNAA		2023920L	Drive Shaft		38	37	63	102.5	1026	





 YEAR	TRANSM.	F/R	L/R	BODY STYLE & DRIVE TYPE & ENGINE	REMARKS	GSP Ref.	 PRODUCT	 ABS	Technical Specifications				
									A	B	C	H	L
VW													
Caravelle													
2.0 (110 kw)													
2015.04-	7DCT	F	R	Bus FWD CXFA/CXHA/DNAA	For Model code:SGF/SGM/SGN	2033530L	Drive Shaft		38	37	63	102.5	1026
2015.08-	6MT	F	L	Bus 4WD CXFA/CXHA	Date To:2017.01	2033600L	Drive Shaft		38	42	63	102.5	617
2015.08-	6MT	F	R	Bus 4WD CXFA/CXHA	Date To:2017.01,Model code:SGB/SGJ	2016660L	Drive Shaft		38	26	63	102.5	616
2015.08-	7DCT	F	L	Bus 4WD CXFA/CXHA	Date to:2020.11	2032930L	Drive Shaft		38	37	63	102.5	647
2015.08-	7DCT	F	R	Bus 4WD CXFA/CXHA	Date to:2020.11	2016650L	Drive Shaft		38	26	63	102.5	614
2015.08-	6MT/7DCT	R	L	Bus 4WD CXFA/CXHA		2612570L	Drive Shaft		38		59	102	683
2015.08-	6MT/7DCT	R	R	Bus 4WD CXFA/CXHA		2612580L	Drive Shaft		38		59	102	743
2.0 (132 kw)													
2009.09-2015.11	6MT	F	L	Bus FWD CFCA	Date From:2013.07	2033600L	Drive Shaft		38	42	63	102.5	617
2009.09-2015.11	6MT	F	L	Bus FWD CFCA	Date to:2013.06	2610840L	Drive Shaft		38	26	63	102.5	616
2009.09-2015.11	6MT	F	R	Bus FWD CFCA	Date From:2013.07,Date To:2015.04	2023610L	Drive Shaft		38	26	63	102.5	879
2009.09-2015.11	6MT	F	R	Bus FWD CFCA		2032960L	Drive Shaft		38	26	63	102.5	880
2009.09-2015.11	6MT	F	R	Bus FWD CFCA	Date From:2015.05	2033610L	Drive Shaft		38	26	63	102.5	881
2009.09-2015.11	7DCT	F	L	Bus FWD CFCA		2032930L	Drive Shaft		38	37	63	102.5	647
2009.09-2015.11	7DCT	F	R	Bus FWD CFCA	Chassis no. From:7HC000001/7HC400001/7HCX00001	2023920L	Drive Shaft		38	37	63	102.5	1026
2009.09-2015.11	7DCT	F	R	Bus FWD CFCA	Chassis no. To:7HB500000/7HB450000/7HBX500000	2033530L	Drive Shaft		38	37	63	102.5	1026
2010.01-2015.11	6MT	F	L	Bus 4WD CFCA	Date From:2013.07	2033600L	Drive Shaft		38	42	63	102.5	617
2010.01-2015.11	6MT	F	L	Bus 4WD CFCA		2610840L	Drive Shaft		38	26	63	102.5	616
2010.01-2015.11	6MT	F	R	Bus 4WD CFCA	Date from:2013.07	2016660L	Drive Shaft		38	26	63	102.5	616
2010.01-2015.11	6MT	F	R	Bus 4WD CFCA	Date to:2013.06	2610840L	Drive Shaft		38	26	63	102.5	616
2010.01-2015.11	7DCT	F	L	Bus 4WD CFCA		2032930L	Drive Shaft		38	37	63	102.5	647
2010.01-2015.11	7DCT	F	R	Bus 4WD CFCA	Chassis no. From:7HC00001/7HC40001/7HCX0001 Date From:2013.07	2016650L	Drive Shaft		38	26	63	102.5	614
2010.01-2015.11	6MT/7DCT	R	L	Bus 4WD CFCA		2612570L	Drive Shaft		38		59	102	683
2010.01-2015.11	6MT/7DCT	R	R	Bus 4WD CFCA		2612580L	Drive Shaft		38		59	102	743
2015.04-	6MT	F	L	Bus FWD CFCA	Outer teeth of transm.side:42	2033600L	Drive Shaft		38	42	63	102.5	617
2015.04-	6MT	F	L	Bus FWD CFCA	Date to:2017.01	2610840L	Drive Shaft		38	26	63	102.5	616
2015.04-	6MT	F	R	Bus FWD CFCA		2033610L	Drive Shaft		38	26	63	102.5	881
2015.04-	7AT/7DCT	F	L	Bus FWD CFCA		2032930L	Drive Shaft		38	37	63	102.5	647
2015.04-	7AT/7DCT	F	R	Bus FWD CFCA		2023920L	Drive Shaft		38	37	63	102.5	1026
2015.06-	6MT	F	L	Bus 4WD CFCA	Outer teeth of transm.side:42	2033600L	Drive Shaft		38	42	63	102.5	617
2015.06-	6MT	F	L	Bus 4WD CFCA	Date to:2017.01	2610840L	Drive Shaft		38	26	63	102.5	616
2015.06-	7AT/7DCT	F	L	Bus 4WD CFCA		2032930L	Drive Shaft		38	37	63	102.5	647
2015.06-	7AT/7DCT	F	R	Bus 4WD CFCA		2016650L	Drive Shaft		38	26	63	102.5	614
2015.06-	7DCT	R	L	Bus 4WD CFCA		2612570L	Drive Shaft		38		59	102	683
2015.06-	7DCT	R	R	Bus 4WD CFCA	Date To:2016.04	2612580L	Drive Shaft		38		59	102	743
2.0 (146 kw)													
2018.08-	7DCT	F	L	Bus 4WD CXEC	Date To:2020.11	2034970L	Drive Shaft		38	37	63	103	646
2018.08-	7DCT	R	L	Bus 4WD CXEC		2612570L	Drive Shaft		38		59	102	683
2018.08-	7DCT	F	L	Bus FWD CXEC	Date To:2020.11	2034970L	Drive Shaft		38	37	63	103	646
2018.08-	7DCT	F	R	Bus FWD CXEC	For Modelcode:SGB/SGJ	2034960L	Drive Shaft		38	37	63	103	1025
2.0 (150 kw)													
2011.05-2015.11	7DCT	F	L	Bus 4WD CJK		2032930L	Drive Shaft		38	37	63	102.5	647
2011.05-2015.11	7DCT	F	R	Bus 4WD CJK		2016650L	Drive Shaft		38	26	63	102.5	614
2011.05-2015.11	7DCT	R	L	Bus 4WD CJK		2612570L	Drive Shaft		38		59	102	683
2011.05-2015.11	7DCT	R	R	Bus 4WD CJK		2612580L	Drive Shaft		38		59	102	743
2011.05-2015.11	6MT	F	L	Bus FWD CJK	Date From:2013.07	2033600L	Drive Shaft		38	42	63	102.5	617
2011.05-2015.11	6MT	F	L	Bus FWD CJK	Date to:2013.06	2610840L	Drive Shaft		38	26	63	102.5	616
2011.05-2015.11	6MT	F	R	Bus FWD CJK	Date From:2013.07,Date To:2015.04	2023610L	Drive Shaft		38	26	63	102.5	879
2011.05-2015.11	6MT	F	R	Bus FWD CJK	Date To:2013.06	2032960L	Drive Shaft		38	26	63	102.5	880
2011.05-2015.11	6MT	F	R	Bus FWD CJK	Date From:2015.05	2033610L	Drive Shaft		38	26	63	102.5	881
2011.05-2015.11	7DCT	F	L	Bus FWD CJK		2032930L	Drive Shaft		38	37	63	102.5	647
2011.05-2015.11	7DCT	F	R	Bus FWD CJK	Chassis no. From:7HC000001/7HC400001/7HCX00001	2023920L	Drive Shaft		38	37	63	102.5	1026
2011.05-2015.11	7DCT	F	R	Bus FWD CJK	Chassis no. To:7HB500000/7HB450000/7HBX500000	2033530L	Drive Shaft		38	37	63	102.5	1026
2015.04-	7AT	F	L	Bus FWD CJK		2032930L	Drive Shaft		38	37	63	102.5	647
2015.04-	7AT	F	R	Bus FWD CJK		2023920L	Drive Shaft		38	37	63	102.5	1026
2015.06-	7AT	F	L	Bus 4WD CJK		2032930L	Drive Shaft		38	37	63	102.5	647
2015.06-	7AT	F	R	Bus 4WD CJK		2016650L	Drive Shaft		38	26	63	102.5	614
2015.06-	7DCT	R	L	Bus 4WD CJK		2612570L	Drive Shaft		38		59	102	683
2015.06-	7DCT	R	R	Bus 4WD CJK	Date To:2016.04	2612580L	Drive Shaft		38		59	102	743
2015.06-	7DCT	F	L	Bus 4WD CXEB/DMZA	Date From:2017.01,Date To:2020.11	2034970L	Drive Shaft		38	37	63	103	646
2015.06-	6MT/7DCT	R	L	Bus 4WD CXEB/DMZA		2612570L	Drive Shaft		38		59	102	683
2015.06-	6MT/7DCT	R	R	Bus 4WD CXEB/DMZA	Date To:2016.04	2612580L	Drive Shaft		38		59	102	743
2015.06-	7DCT	F	L	Bus FWD CXEB/DMZA	Date From:2017.02,Date To:2020.11	2034970L	Drive Shaft		38	37	63	103	646
2015.06-	7DCT	F	R	Bus FWD CXEB/DMZA	For Modelcode:SGB/SGJ	2034960L	Drive Shaft		38	37	63	103	1025
2.5 (96 kw)													
2003.04-2009.11	6MT	F	L	Bus 4WD AXD/BNZ		2610840L	Drive Shaft		38	26	63	102.5	616
2003.04-2009.11	6MT	R	L	Bus 4WD AXD/BNZ		2612570L	Drive Shaft		38		59	102	683
2003.04-2009.11	6MT	R	R	Bus 4WD AXD/BNZ		2612580L	Drive Shaft		38		59	102	743
2003.04-2009.11	6MT	F	L	Bus FWD AXD/BNZ		2610840L	Drive Shaft		38	26	63	102.5	616



		TRANSM.	F/R	L/R	BODY STYLE & DRIVE TYPE & ENGINE	REMARKS	GSP Ref.		Technical Specifications					
									ABS	A	B	C	H	L
VW														
Caravelle														
2.5 (120 kw)	2006.01-2009.11	6MT	F	L	Bus FWD BLJ		2610840L	Drive Shaft		38	26	63	102.5	616
2.5 (128 kw)	2003.04-2009.11	6MT	F	L	Bus FWD AXE/BPC		2033600L	Drive Shaft		38	42	63	102.5	617
	2003.04-2009.11	6MT	F	L	Bus FWD AXE/BPC		2610840L	Drive Shaft		38	26	63	102.5	616
	2004.07-2009.11	6MT	F	L	Bus 4WD AXE/BPC		2610840L	Drive Shaft		38	26	63	102.5	616
	2004.07-2009.11	6MT	R	L	Bus 4WD AXE/BPC		2612570L	Drive Shaft		38		59	102	683
	2004.07-2009.11	6MT	R	R	Bus 4WD AXE/BPC		2612580L	Drive Shaft		38		59	102	743
3.2 (173 kw)	2008.05-2009.12	6MT	R	L	Bus 4WD BKK/CFLA		2612570L	Drive Shaft		38		59	102	683
	2008.05-2009.12	6MT	R	R	Bus 4WD BKK/CFLA		2612580L	Drive Shaft		38		59	102	743
CC														
1.4 (110 kw)	2015.05-2016.12	6MT	F	L	Coupe FWD CZDA		2612820L	Drive Shaft		36		59.5	40	523
	2015.05-2016.12	7DCT	F	L	Coupe FWD CZDA		2611000L	Drive Shaft		36		59.5	40.5	514
	2015.05-2016.12	7DCT	F	R	Coupe FWD CZDA		2033130L	Drive Shaft		36		59.5	40.5	794
1.4 (118 kw)	2011.11-2016.12	6MT	F	L	Coupe FWD CKMA		2612010L	Drive Shaft		36		59.5	40	536
	2011.11-2016.12	6MT	F	R	Coupe FWD CKMA		2610960L	Drive Shaft		36		59.5	40	800
	2011.11-2016.12	7DCT	F	L	Coupe FWD CKMA		2612810L	Drive Shaft		36		59.5	40.5	525
	2011.11-2016.12	7DCT	F	R	Coupe FWD CKMA		2016530L	Drive Shaft		36		59.5	40.5	785
	2011.11-2016.12	6MT	F	L	Coupe FWD CTHD		2612010L	Drive Shaft		36		59.5	40	536
	2011.11-2016.12	6MT	F	R	Coupe FWD CTHD		2610960L	Drive Shaft		36		59.5	40	800
	2011.11-2016.12	7DCT	F	L	Coupe FWD CTHD		2612810L	Drive Shaft		36		59.5	40.5	525
	2011.11-2016.12	7DCT	F	R	Coupe FWD CTHD		2016530L	Drive Shaft		36		59.5	40.5	785
	1.8 (112 kw)	2011.11-2016.12	6MT/7DCT	F	L	Coupe FWD CDAB		2611000L	Drive Shaft		36		59.5	40.5
2011.11-2016.12		7DCT	F	R	Coupe FWD CDAB		2033130L	Drive Shaft		36		59.5	40.5	794
2011.11-2016.12		AT	F	R	Coupe FWD CDAB		2610940L	Drive Shaft		36	26	59.5	40	884
2011.11-2016.12		MT/6MT	F	R	Coupe FWD CDAB		2613410L	Drive Shaft		36		59.5	40.5	806
1.8 (118 kw)	2011.11-2016.12	6MT	F	R	Coupe FWD CDAA		2613410L	Drive Shaft		36		59.5	40.5	806
	2011.11-2016.12	7AT	F	L	Coupe FWD CDAA		2033800L	Drive Shaft		36		59.5	40	487
	2011.11-2016.12	7DCT	F	L	Coupe FWD CDAA		2611000L	Drive Shaft		36		59.5	40.5	514
	2011.11-2016.12	7DCT	F	R	Coupe FWD CDAA		2033130L	Drive Shaft		36		59.5	40.5	794
	2011.11-2016.12	AT	F	R	Coupe FWD CDAA		2610940L	Drive Shaft		36	26	59.5	40	884
2.0 (100 kw)	2011.11-2016.12	6DCT	F	L	Coupe FWD CFFA		2540130L	Drive Shaft		36		59.5	40.5	482
	2011.11-2016.12	6DCT	F	R	Coupe FWD CFFA		2540110L	Drive Shaft		36		59.5	40.5	760
	2011.11-2016.12	6MT	F	L	Coupe FWD CFFA		2032950L	Drive Shaft		36		59.5	40.5	486
	2011.11-2016.12	MT/6MT	F	R	Coupe FWD CFFA		2033130L	Drive Shaft		36		59.5	40.5	794
2.0 (103 kw)	2011.11-2016.12	6MT	F	L	Coupe 4WD CFFB		2032950L	Drive Shaft		36		59.5	40.5	486
	2011.11-2016.12	6MT	F	R	Coupe 4WD CFFB		2032660L	Drive Shaft		36		59.5	40.5	601
	2011.11-2016.12	MT	F	L	Coupe 4WD CFFB		2033800L	Drive Shaft		36		59.5	40	487
	2011.11-2016.12	6DCT	F	L	Coupe FWD CFFB		2540130L	Drive Shaft		36		59.5	40.5	482
	2011.11-2016.12	6DCT	F	R	Coupe FWD CFFB		2540110L	Drive Shaft		36		59.5	40.5	760
	2011.11-2016.12	6MT	F	L	Coupe FWD CFFB		2032950L	Drive Shaft		36		59.5	40.5	486
	2011.11-2016.12	6MT	F	R	Coupe FWD CFFB		2033130L	Drive Shaft		36		59.5	40.5	794
	2011.11-2016.12	MT	F	L	Coupe FWD CFFB		2033800L	Drive Shaft		36		59.5	40	487
	2.0 (110 kw)	2015.05-2016.12	6DCT	F	R	Coupe FWD CUVC		2033540L	Drive Shaft		36		59.5	40
2015.05-2016.12		6MT	F	R	Coupe FWD CUVC		2033130L	Drive Shaft		36		59.5	40.5	794
2015.05-2016.12		AT	F	R	Coupe FWD CUVC		2540110L	Drive Shaft		36		59.5	40.5	760
2.0 (125 kw)		2011.11-2013.01	6AT	F	L	Coupe 4WD CFGB		2033810L	Drive Shaft		36		59.5	40
	2011.11-2013.01	6AT	F	L	Coupe 4WD CFGB		2540130L	Drive Shaft		36		59.5	40.5	482
	2011.11-2016.12	6DCT	F	L	Coupe FWD CFGB/CLLA	Date To:2013.05	2540130L	Drive Shaft		36		59.5	40.5	482
	2011.11-2016.12	6DCT	F	R	Coupe FWD CFGB/CLLA	Date From:2013.06	2033540L	Drive Shaft		36		59.5	40	760
	2011.11-2016.12	6DCT	F	R	Coupe FWD CFGB/CLLA	Date To:2013.05	2540110L	Drive Shaft		36		59.5	40.5	760
	2011.11-2016.12	6MT	F	L	Coupe FWD CFGB/CLLA	Date To:2013.05	2033800L	Drive Shaft		36		59.5	40	487
	2011.11-2016.12	6MT	F	R	Coupe FWD CFGB/CLLA	Date From:2013.06	2033130L	Drive Shaft		36		59.5	40.5	794
	2.0 (130 kw)	2012.12-2016.12	6AT	F	L	Coupe 4WD CFGC		2033810L	Drive Shaft		36		59.5	40
2012.12-2016.12		6AT	F	L	Coupe 4WD CFGC		2540130L	Drive Shaft		36		59.5	40.5	482
2012.12-2016.12		6DCT	F	L	Coupe FWD CFGC	Date To:2013.05	2540130L	Drive Shaft		36		59.5	40.5	482
2012.12-2016.12		6DCT	F	R	Coupe FWD CFGC	Date From:2013.06	2033540L	Drive Shaft		36		59.5	40	760
2012.12-2016.12		6MT	F	L	Coupe FWD CFGC	Date To:2013.05	2033800L	Drive Shaft		36		59.5	40	487
2.0 (135 kw)	2012.12-2016.12	6MT	F	R	Coupe FWD CFGC	Date From:2013.06	2033130L	Drive Shaft		36		59.5	40.5	794
	2015.05-2016.12	6DCT	F	R	Coupe FWD CUWA		2033540L	Drive Shaft		36		59.5	40	760
	2015.05-2016.12	6MT	F	R	Coupe FWD CUWA		2033130L	Drive Shaft		36		59.5	40.5	794
2.0 (155 kw)	2015.05-2016.12	AT	F	R	Coupe FWD CUWA		2540110L	Drive Shaft		36		59.5	40.5	760
2.0 (155 kw)	2011.11-2016.12	6MT	F	R	Coupe FWD CCZB		2611470L	Drive Shaft		36		59.5	40.5	795
3.6 (220 kw)	2011.11-2016.12	6AT	F	L	Coupe 4WD BWS		2032950L	Drive Shaft		36		59.5	40.5	486
Crafter 30														
2.0 (103 kw)	2016.09-	6MT	F	L	Van FWD DAUA	Date from:2017.04	2039380L	Drive Shaft		44	42	72.4	109.5	722
	2016.09-	6MT	F	R	Van FWD DAUA	Date from:2017.04	2039350L	Drive Shaft		44	42	72.4	109.5	1089



 YEAR	TRANSM.	F/R	L/R	BODY STYLE & DRIVE TYPE & ENGINE	REMARKS	GSP Ref.	 PRODUCT	 ABS	Technical Specifications					
									A	B	C	H	L	
VW														
Crafter 30														
2.0 (103 kw)	2016.09-	8AT	F	L	Van FWD DAUA		2039370L	Drive Shaft		44	42	72.4	109.5	707
	2016.09-	8AT	F	R	Van FWD DAUA		2039350L	Drive Shaft		44	42	72.4	109.5	1089
	2017.04-	6MT	F	L	Van 4WD DAUA		2039380L	Drive Shaft		44	42	72.4	109.5	722
	2017.04-	6MT	F	R	Van 4WD DAUA		2039360L	Drive Shaft		44	26	72.4	109.5	687
2.0 (130 kw)	2016.09-	6MT	F	L	Van FWD DAVA	Date from:2017.04	2039380L	Drive Shaft		44	42	72.4	109.5	722
	2016.09-	6MT	F	R	Van FWD DAVA	Date from:2017.04	2039350L	Drive Shaft		44	42	72.4	109.5	1089
	2016.09-	8AT	F	L	Van FWD DAVA		2039370L	Drive Shaft		44	42	72.4	109.5	707
	2016.09-	8AT	F	R	Van FWD DAVA		2039350L	Drive Shaft		44	42	72.4	109.5	1089
	2017.03-	6MT/8AT	F	L	Van 4WD DAVA	Date From:2017.04	2039380L	Drive Shaft		44	42	72.4	109.5	722
	2017.03-	6MT/8AT	F	R	Van 4WD DAVA	Date From:2017.04	2039360L	Drive Shaft		44	26	72.4	109.5	687
Crafter 35														
2.0 (103 kw)	2016.09-	6MT/8AT	F	L	Bus FWD DAUA/DNAE	Date From:2017.04	2039380L	Drive Shaft		44	42	72.4	109.5	722
	2016.09-	6MT/8AT	F	R	Bus FWD DAUA/DNAE	Date From:2017.04	2039350L	Drive Shaft		44	42	72.4	109.5	1089
	2016.09-	6MT	F	L	Van FWD DAUA	Date from:2017.04	2039380L	Drive Shaft		44	42	72.4	109.5	722
	2016.09-	6MT	F	R	Van FWD DAUA	Date from:2017.04	2039350L	Drive Shaft		44	42	72.4	109.5	1089
	2016.09-	8AT	F	L	Van FWD DAUA		2039370L	Drive Shaft		44	42	72.4	109.5	707
	2016.09-	8AT	F	R	Van FWD DAUA		2039350L	Drive Shaft		44	42	72.4	109.5	1089
	2016.11-	6MT	F	L	Platform/Chassis FWD DAUA/DNAE	Date from:2017.04	2039380L	Drive Shaft		44	42	72.4	109.5	722
	2016.11-	6MT	F	R	Platform/Chassis FWD DAUA/DNAE	Date from:2017.04	2039350L	Drive Shaft		44	42	72.4	109.5	1089
	2016.11-	8AT	F	L	Platform/Chassis FWD DAUA/DNAE		2039370L	Drive Shaft		44	42	72.4	109.5	707
	2016.11-	8AT	F	R	Platform/Chassis FWD DAUA/DNAE		2039350L	Drive Shaft		44	42	72.4	109.5	1089
	2017.04-	6MT	F	L	Bus 4WD DAUA/DNAE		2039380L	Drive Shaft		44	42	72.4	109.5	722
	2017.04-	6MT	F	R	Bus 4WD DAUA/DNAE		2039360L	Drive Shaft		44	26	72.4	109.5	687
	2017.04-	6MT	F	L	Van 4WD DAUA		2039380L	Drive Shaft		44	42	72.4	109.5	722
	2017.04-	6MT	F	R	Van 4WD DAUA		2039360L	Drive Shaft		44	26	72.4	109.5	687
	2017.11-	6MT	F	L	Platform/Chassis 4WD DAUA/DNAE		2039380L	Drive Shaft		44	42	72.4	109.5	722
	2017.11-	6MT	F	R	Platform/Chassis 4WD DAUA/DNAE		2039360L	Drive Shaft		44	26	72.4	109.5	687
2.0 (130 kw)	2016.09-	6MT/8AT	F	L	Bus FWD DAVA/DMZB	Date From:2017.04	2039380L	Drive Shaft		44	42	72.4	109.5	722
	2016.09-	6MT/8AT	F	R	Bus FWD DAVA/DMZB	Date From:2017.04	2039350L	Drive Shaft		44	42	72.4	109.5	1089
	2016.09-	6MT	F	L	Van FWD DAVA	Date from:2017.04	2039380L	Drive Shaft		44	42	72.4	109.5	722
	2016.09-	6MT	F	R	Van FWD DAVA	Date from:2017.04	2039350L	Drive Shaft		44	42	72.4	109.5	1089
	2016.09-	8AT	F	L	Van FWD DAVA		2039370L	Drive Shaft		44	42	72.4	109.5	707
	2016.09-	8AT	F	R	Van FWD DAVA		2039350L	Drive Shaft		44	42	72.4	109.5	1089
	2016.11-	6MT	F	L	Platform/Chassis FWD DAVA/DMZB	Date from:2017.04	2039380L	Drive Shaft		44	42	72.4	109.5	722
	2016.11-	6MT	F	R	Platform/Chassis FWD DAVA/DMZB	Date from:2017.04	2039350L	Drive Shaft		44	42	72.4	109.5	1089
	2016.11-	8AT	F	L	Platform/Chassis FWD DAVA/DMZB		2039370L	Drive Shaft		44	42	72.4	109.5	707
	2016.11-	8AT	F	R	Platform/Chassis FWD DAVA/DMZB		2039350L	Drive Shaft		44	42	72.4	109.5	1089
	2017.03-	6MT	F	L	Bus 4WD DAVA/DMZB		2039380L	Drive Shaft		44	42	72.4	109.5	722
	2017.03-	6MT/8AT	F	R	Bus 4WD DAVA/DMZB		2039360L	Drive Shaft		44	26	72.4	109.5	687
	2017.03-	8AT	F	L	Bus 4WD DAVA/DMZB		2039370L	Drive Shaft		44	42	72.4	109.5	707
	2017.03-	6MT/8AT	F	L	Van 4WD DAVA	Date From:2017.04	2039380L	Drive Shaft		44	42	72.4	109.5	722
	2017.03-	6MT/8AT	F	R	Van 4WD DAVA	Date From:2017.04	2039360L	Drive Shaft		44	26	72.4	109.5	687
	2017.11-	6MT/8AT	F	L	Platform/Chassis 4WD DAVA/DMZB		2039380L	Drive Shaft		44	42	72.4	109.5	722
2017.11-	6MT/8AT	F	R	Platform/Chassis 4WD DAVA/DMZB		2039360L	Drive Shaft		44	26	72.4	109.5	687	
Eos														
1.4 (90 kw)	2007.11-2015.08	6MT	F	L	Cabriolet FWD CAXA		2612010L	Drive Shaft		36		59.5	40	536
	2007.11-2015.08	6MT	F	R	Cabriolet FWD CAXA		2610960L	Drive Shaft		36		59.5	40	800
1.4 (118 kw)	2008.05-2015.08	6MT	F	L	Cabriolet FWD CAVD/CTHD		2612010L	Drive Shaft		36		59.5	40	536
	2008.05-2015.08	6MT	F	R	Cabriolet FWD CAVD/CTHD		2610960L	Drive Shaft		36		59.5	40	800
1.6 (85 kw)	2006.05-2008.05	6MT	F	L	Cabriolet FWD BLF		2612010L	Drive Shaft		36		59.5	40	536
	2006.05-2008.05	6MT	F	R	Cabriolet FWD BLF		2610960L	Drive Shaft		36		59.5	40	800
	2006.05-2008.05	AT	F	R	Cabriolet FWD BLF		2610940L	Drive Shaft		36	26	59.5	40	884
	2006.05-2008.05	MT	F	R	Cabriolet FWD BLF		2612110L	Drive Shaft		36		59.5	40.5	784
2.0 (100 kw)	2010.11-2015.08	6DCT	F	L	Cabriolet FWD CFFA		2033810L	Drive Shaft		36		59.5	40	485
	2010.11-2015.08	6DCT	F	L	Cabriolet FWD CFFA		2540130L	Drive Shaft		36		59.5	40.5	482
	2010.11-2015.08	6DCT	F	R	Cabriolet FWD CFFA		2540110L	Drive Shaft		36		59.5	40.5	760
	2010.11-2015.08	6MT	F	L	Cabriolet FWD CFFA		2032950L	Drive Shaft		36		59.5	40.5	486
	2010.11-2015.08	6MT	F	R	Cabriolet FWD CFFA		2033130L	Drive Shaft		36		59.5	40.5	794
	2010.11-2015.08	MT	F	L	Cabriolet FWD CFFA		2033800L	Drive Shaft		36		59.5	40	487
2.0 (103 kw)	2006.05-2008.05	6DCT	F	L	Cabriolet FWD BMM		2540130L	Drive Shaft		36		59.5	40.5	482
	2006.05-2008.05	6DCT	F	R	Cabriolet FWD BMM		2540110L	Drive Shaft		36		59.5	40.5	760
	2006.05-2008.05	6MT	F	L	Cabriolet FWD BMM		2032950L	Drive Shaft		36		59.5	40.5	486
	2006.05-2008.05	6MT	F	R	Cabriolet FWD BMM		2033130L	Drive Shaft		36		59.5	40.5	794
	2006.05-2008.05	MT	F	L	Cabriolet FWD BMM		2033800L	Drive Shaft		36		59.5	40	487
	2008.05-2015.08	6DCT	F	L	Cabriolet FWD CBAB/CFFB		2540130L	Drive Shaft		36		59.5	40.5	482



		TRANSM.	F/R	L/R	BODY STYLE & DRIVE TYPE & ENGINE	REMARKS	GSP Ref.		Technical Specifications									
									PRODUCT	ABS	A	B	C	H	L			
VW Eos																		
2.0 (103 kw)	2008.05-2015.08	6DCT	F	R	Cabriolet FWD CBAB/CFFB		2540110L	Drive Shaft		36		59.5	40.5	760				
	2008.05-2015.08	6MT	F	L	Cabriolet FWD CBAB/CFFB		2032950L	Drive Shaft		36		59.5	40.5	486				
	2008.05-2015.08	6MT	F	R	Cabriolet FWD CBAB/CFFB		2033130L	Drive Shaft		36		59.5	40.5	794				
	2008.05-2015.08	MT	F	L	Cabriolet FWD CBAB/CFFB		2033800L	Drive Shaft		36		59.5	40	487				
2.0 (110 kw)	2006.03-2008.05	6MT	F	L	Cabriolet FWD BVY/BVZ		2032940L	Drive Shaft		36		59.5	40	517				
	2006.03-2008.05	6MT	F	R	Cabriolet FWD BVY/BVZ		2610420L	Drive Shaft		36		59.5	40	814				
	2006.03-2008.05	AT	F	R	Cabriolet FWD BVY/BVZ		2610940L	Drive Shaft		36	26	59.5	40	884				
2.0 (147 kw)	2006.05-2015.08	6DCT	F	R	Cabriolet FWD BPY/BWA/CABW/CBFA/CCTA/CCZA		2016530L	Drive Shaft		36		59.5	40.5	785				
	2006.05-2015.08	6MT	F	L	Cabriolet FWD BPY/BWA/CABW/CBFA/CCTA/CCZA		2032950L	Drive Shaft		36		59.5	40.5	486				
	2006.05-2015.08	6MT	F	R	Cabriolet FWD BPY/BWA/CABW/CBFA/CCTA/CCZA	Date from:2009.12	2033130L	Drive Shaft		36		59.5	40.5	794				
	2006.05-2015.08	6MT	F	R	Cabriolet FWD BPY/BWA/CABW/CBFA/CCTA/CCZA		2611470L	Drive Shaft		36		59.5	40.5	795				
2.0 (155 kw)	2009.11-2015.08	6DCT	F	L	Cabriolet FWD CCZB		2033800L	Drive Shaft		36		59.5	40	487				
	2009.11-2015.08	6DCT	F	R	Cabriolet FWD CCZB		2016530L	Drive Shaft		36		59.5	40.5	785				
	2009.11-2015.08	6MT	F	L	Cabriolet FWD CCZB		2032950L	Drive Shaft		36		59.5	40.5	486				
	2009.11-2015.08	6MT	F	R	Cabriolet FWD CCZB		2611470L	Drive Shaft		36		59.5	40.5	795				
3.2 (184 kw)	2006.05-2009.05	6AT	F	R	Cabriolet FWD BUB/CBRA		2033540L	Drive Shaft		36		59.5	40	760				
3.6 (191 kw)	2009.05-2010.11	6AT	F	R	Cabriolet FWD CDVA	Date From:2009.10	2016530L	Drive Shaft		36		59.5	40.5	785				
Golf																		
1.2 (63 kw)	2010.05-2012.11	AT/MT	F	L	Hatchback FWD CBZA		2612010L	Drive Shaft		36		59.5	40	536				
	2010.05-2012.11	AT/MT	F	R	Hatchback FWD CBZA		2610960L	Drive Shaft		36		59.5	40	800				
	2010.05-2012.11	MT	F	L	Hatchback Van FWD CBZA		2612010L	Drive Shaft		36		59.5	40	536				
	2010.05-2012.11	MT	F	R	Hatchback Van FWD CBZA		2610960L	Drive Shaft		36		59.5	40	800				
	2012.08-	5MT	F	L	Hatchback Van FWD CJZB	For PR code:0EC	2033730L	Drive Shaft		36		59.5	40	517				
	2012.08-	5MT	F	R	Hatchback Van FWD CJZB		2610960L	Drive Shaft		36		59.5	40	800				
	2012.08-	MT	F	L	Hatchback Van FWD CJZB	Date From:2013.01	2032940L	Drive Shaft		36		59.5	40	517				
	2012.08-	MT	F	R	Hatchback Van FWD CJZB	Date From:2013.01	2610420L	Drive Shaft		36		59.5	40	814				
	2012.08-2017.03	5MT	F	L	Hatchback FWD CJZB/CYVA		2032940L	Drive Shaft		36		59.5	40	517				
	2012.08-2017.03	5MT	F	L	Hatchback FWD CJZB/CYVA	For PR code:1PE/1PF/1PA+2H4	2033730L	Drive Shaft		36		59.5	40	517				
	2012.08-2017.03	5MT	F	R	Hatchback FWD CJZB/CYVA		2610420L	Drive Shaft		36		59.5	40	814				
	2012.08-2017.03	5MT	F	R	Hatchback FWD CJZB/CYVA		2610960L	Drive Shaft		36		59.5	40	800				
	2012.08-2017.03	5MT	F	R	Hatchback FWD CJZB/CYVA		2613070L	Drive Shaft		36		59.5	40	820				
1.2 (77 kw)	2009.05-2012.11	AT/MT	F	L	Hatchback FWD CBZB		2612010L	Drive Shaft		36		59.5	40	536				
	2009.05-2012.11	AT/MT	F	R	Hatchback FWD CBZB		2610960L	Drive Shaft		36		59.5	40	800				
	2009.05-2012.11	AT/MT	F	L	Hatchback Van FWD CBZB		2612010L	Drive Shaft		36		59.5	40	536				
	2009.05-2012.11	AT/MT	F	R	Hatchback Van FWD CBZB		2610960L	Drive Shaft		36		59.5	40	800				
	2012.11-	6MT	F	L	Hatchback Van FWD CJZA		2033730L	Drive Shaft		36		59.5	40	517				
	2012.11-	6MT	F	R	Hatchback Van FWD CJZA		2613070L	Drive Shaft		36		59.5	40	820				
	2012.11-	7DCT	F	L	Hatchback Van FWD CJZA		2612820L	Drive Shaft		36		59.5	40	523				
	2012.11-	7DCT	F	R	Hatchback Van FWD CJZA		2610960L	Drive Shaft		36		59.5	40	800				
	2012.11-	MT	F	L	Hatchback Van FWD CJZA	Date From:2013.01	2032940L	Drive Shaft		36		59.5	40	517				
	2012.11-	MT	F	R	Hatchback Van FWD CJZA	Date From:2013.01	2610420L	Drive Shaft		36		59.5	40	814				
	2012.11-2017.03	5MT/6MT	F	L	Hatchback FWD CJZA		2033730L	Drive Shaft		36		59.5	40	517				
	2012.11-2017.03	5MT/6MT	F	R	Hatchback FWD CJZA		2613070L	Drive Shaft		36		59.5	40	820				
	2012.11-2017.03	7DCT	F	L	Hatchback FWD CJZA		2612820L	Drive Shaft		36		59.5	40	523				
	2012.11-2017.03	7DCT	F	R	Hatchback FWD CJZA		2610960L	Drive Shaft		36		59.5	40	800				
	2012.11-2017.03	MT	F	L	Hatchback FWD CJZA		2032940L	Drive Shaft		36		59.5	40	517				
	2012.11-2017.03	MT	F	R	Hatchback FWD CJZA		2610420L	Drive Shaft		36		59.5	40	814				
1.2 (81 kw)	2014.05-	6MT	F	L	Hatchback FWD CYVB		2033730L	Drive Shaft		36		59.5	40	517				
	2014.05-	6MT	F	R	Hatchback FWD CYVB		2613070L	Drive Shaft		36		59.5	40	820				
	2014.05-	7DCT	F	L	Hatchback FWD CYVB		2612820L	Drive Shaft		36		59.5	40	523				
	2014.05-	7DCT	F	R	Hatchback FWD CYVB		2610960L	Drive Shaft		36		59.5	40	800				
1.4 (81 kw)	2013.05-	6MT	F	R	Hatchback FWD CPWA/CZBA		2613070L	Drive Shaft		36		59.5	40	820				
	2013.05-	6MT/7DCT	F	L	Hatchback FWD CPWA/CZBA		2612820L	Drive Shaft		36		59.5	40	523				
	2013.05-	7DCT	F	R	Hatchback FWD CPWA/CZBA		2610960L	Drive Shaft		36		59.5	40	800				
	2013.05-	MT/7AT	F	L	Hatchback FWD CPWA/CZBA		2032940L	Drive Shaft		36		59.5	40	517				
1.4 (90 kw)	2007.07-2008.11	MT	F	L	Hatchback FWD CAXA		2612010L	Drive Shaft		36		59.5	40	536				
	2007.07-2008.11	MT	F	R	Hatchback FWD CAXA		2610960L	Drive Shaft		36		59.5	40	800				
	2008.10-2012.11	AT	F	L	Hatchback FWD CAXA	Date To:2011.05	2612810L	Drive Shaft		36		59.5	40.5	525				
	2008.10-2012.11	AT	F	R	Hatchback FWD CAXA	Date To:2011.05	2016530L	Drive Shaft		36		59.5	40.5	785				
	2008.10-2012.11	AT/6MT/7DCT	F	L	Hatchback FWD CAXA	Date From:2011.06	2612010L	Drive Shaft		36		59.5	40	536				
	2008.10-2012.11	AT/6MT/7DCT	F	R	Hatchback FWD CAXA	Date From:2011.06	2610960L	Drive Shaft		36		59.5	40	800				
	2008.10-2012.11	AT	F	L	Hatchback Van FWD CAXA	Date From:2011.06	2612010L	Drive Shaft		36		59.5	40	536				
	2008.10-2012.11	AT	F	L	Hatchback Van FWD CAXA	Date To:2011.05	2612810L	Drive Shaft		36		59.5	40.5	525				
	2008.10-2012.11	AT	F	R	Hatchback Van FWD CAXA	Date To:2011.05	2016530L	Drive Shaft		36		59.5	40.5	785				
	2008.10-2012.11	AT	F	R	Hatchback Van FWD CAXA	Date From:2011.06	2610960L	Drive Shaft		36		59.5	40	800				



 YEAR	TRANSM.	F/R	L/R	BODY STYLE & DRIVE TYPE & ENGINE	REMARKS	GSP Ref.	 PRODUCT	 ABS	Technical Specifications						
									A	B	C	H	L		
VW Golf															
1.4 (90 kw)	2008.10-2012.11	MT	F	L	Hatchback Van FWD CAXA	PR code:OEM/OEJ	2612010L	Drive Shaft		36		59.5	40	536	
	2008.10-2012.11	MT	F	R	Hatchback Van FWD CAXA	PR code:OEM/OEJ	2610960L	Drive Shaft		36		59.5	40	800	
	2012.11-	6MT	F	R	Hatchback FWD CMBA/CXSA		2613070L	Drive Shaft		36		59.5	40	820	
	2012.11-	6MT/7DCT	F	L	Hatchback FWD CMBA/CXSA		2612820L	Drive Shaft		36		59.5	40	523	
	2012.11-	7DCT	F	R	Hatchback FWD CMBA/CXSA		2610960L	Drive Shaft		36		59.5	40	800	
	2012.11-	6MT	F	L	Hatchback FWD CPVA		2612820L	Drive Shaft		36		59.5	40	523	
	2012.11-	6MT	F	R	Hatchback FWD CPVA		2613070L	Drive Shaft		36		59.5	40	820	
	2012.11-	AT	F	L	Hatchback FWD CPVA		2612010L	Drive Shaft		36		59.5	40	536	
	2013.05-	6MT	F	R	Hatchback Van FWD CXSA		2613070L	Drive Shaft		36		59.5	40	820	
	2013.05-	6MT/7DCT	F	L	Hatchback Van FWD CXSA		2612820L	Drive Shaft		36		59.5	40	523	
	2013.05-	7DCT	F	R	Hatchback Van FWD CXSA		2610960L	Drive Shaft		36		59.5	40	800	
1.4 (92 kw)	2014.05-	6MT	F	L	Hatchback FWD CPVB		2612820L	Drive Shaft		36		59.5	40	523	
	2014.05-	6MT	F	R	Hatchback FWD CPVB		2613070L	Drive Shaft		36		59.5	40	820	
	2014.05-	7AT	F	L	Hatchback FWD CPVB		2032940L	Drive Shaft		36		59.5	40	517	
	2014.05-	AT	F	R	Hatchback FWD CPVB		2610960L	Drive Shaft		36		59.5	40	800	
	2014.05-	6MT	F	L	Hatchback FWD CZCA		2612820L	Drive Shaft		36		59.5	40	523	
	2014.05-	6MT	F	R	Hatchback FWD CZCA		2613070L	Drive Shaft		36		59.5	40	820	
	2014.05-	7DCT	F	L	Hatchback FWD CZCA	For PR code:7GR,Exhaust Emission no.:Euro 5	2611000L	Drive Shaft		36		59.5	40.5	514	
	2014.05-	7DCT	F	R	Hatchback FWD CZCA	For PR code:7GR,Exhaust Emission no.:Euro 5	2033130L	Drive Shaft		36		59.5	40.5	794	
	2014.05-	7DCT	F	R	Hatchback FWD CZCA		2610960L	Drive Shaft		36		59.5	40	800	
	2014.05-	MT/7AT	F	L	Hatchback FWD CZCA		2032940L	Drive Shaft		36		59.5	40	517	
1.4 (103 kw)	2006.05-2008.11	6MT	F	L	Hatchback FWD BMY		2612010L	Drive Shaft		36		59.5	40	536	
	2006.05-2008.11	6MT	F	R	Hatchback FWD BMY		2610960L	Drive Shaft		36		59.5	40	800	
	2006.05-2008.11	AT	F	L	Hatchback FWD BMY		2033800L	Drive Shaft		36		59.5	40	487	
	2012.08-	6MT	F	L	Hatchback Van FWD CHPA		2612820L	Drive Shaft		36		59.5	40	523	
	2012.08-	6MT	F	R	Hatchback Van FWD CHPA		2612830L	Drive Shaft		36		59.5	40	815	
	2012.08-	7DCT	F	L	Hatchback Van FWD CHPA		2611000L	Drive Shaft		36		59.5	40.5	514	
	2012.08-	7DCT	F	R	Hatchback Van FWD CHPA		2033130L	Drive Shaft		36		59.5	40.5	794	
	2012.08-2017.03	6MT	F	L	Hatchback FWD CHPA/CPTA		2612820L	Drive Shaft		36		59.5	40	523	
	2012.08-2017.03	6MT	F	R	Hatchback FWD CHPA/CPTA		2612830L	Drive Shaft		36		59.5	40	815	
	2012.08-2017.03	7DCT	F	L	Hatchback FWD CHPA/CPTA		2611000L	Drive Shaft		36		59.5	40.5	514	
	2012.08-2017.03	7DCT	F	R	Hatchback FWD CHPA/CPTA		2033130L	Drive Shaft		36		59.5	40.5	794	
	2012.08-2017.03	MT	F	L	Hatchback FWD CHPA/CPTA		2032940L	Drive Shaft		36		59.5	40	517	
1.4 (110 kw)	2014.05-	6MT	F	L	Hatchback FWD CZDA/CZEA		2612820L	Drive Shaft		36		59.5	40	523	
	2014.05-	6MT	F	R	Hatchback FWD CZDA/CZEA		2612830L	Drive Shaft		36		59.5	40	815	
	2014.05-	7DCT	F	L	Hatchback FWD CZDA/CZEA		2611000L	Drive Shaft		36		59.5	40.5	514	
	2014.05-	7DCT	F	R	Hatchback FWD CZDA/CZEA		2033130L	Drive Shaft		36		59.5	40.5	794	
	2014.05-	MT	F	L	Hatchback FWD CZDA/CZEA		2032940L	Drive Shaft		36		59.5	40	517	
1.4 (118 kw)	2008.10-2012.11	AT	F	L	Hatchback FWD CAVD/CNWA/CTHD		2612810L	Drive Shaft		36		59.5	40.5	525	
	2008.10-2012.11	AT	F	R	Hatchback FWD CAVD/CNWA/CTHD		2016530L	Drive Shaft		36		59.5	40.5	785	
	2008.10-2012.11	MT	F	L	Hatchback FWD CAVD/CNWA/CTHD		2612010L	Drive Shaft		36		59.5	40	536	
	2008.10-2012.11	MT	F	R	Hatchback FWD CAVD/CNWA/CTHD		2610960L	Drive Shaft		36		59.5	40	800	
	2008.10-2012.11	AT	F	L	Hatchback Van FWD CAVD		2612810L	Drive Shaft		36		59.5	40.5	525	
	2008.10-2012.11	AT	F	R	Hatchback Van FWD CAVD		2016530L	Drive Shaft		36		59.5	40.5	785	
	2008.10-2012.11	MT	F	L	Hatchback Van FWD CAVD		2612010L	Drive Shaft		36		59.5	40	536	
	2008.10-2012.11	MT	F	R	Hatchback Van FWD CAVD		2610960L	Drive Shaft		36		59.5	40	800	
1.4 (125 kw)	2005.11-2008.11	6MT	F	R	Hatchback FWD BLG		2016530L	Drive Shaft		36		59.5	40.5	785	
	2005.11-2008.11	AT	F	L	Hatchback FWD BLG		2033800L	Drive Shaft		36		59.5	40	487	
1.5 (96 kw)	2017.05-2020.08	7DCT	F	L	Hatchback FWD DACA		2612820L	Drive Shaft		36		59.5	40	523	
	2018.11-	6MT	F	R	Hatchback FWD DHFA		2610960L	Drive Shaft		36		59.5	40	800	
	2018.11-	6MT/7DCT	F	L	Hatchback FWD DHFA		2612820L	Drive Shaft		36		59.5	40	523	
	2020.11-	7DCT	F	L	Hatchback FWD DPBA		2612820L	Drive Shaft		36		59.5	40	523	
1.5 (110 kw)	2017.03-	6MT	F	L	Hatchback FWD DADA/DPCA		2612820L	Drive Shaft		36		59.5	40	523	
	2017.03-	7DCT	F	L	Hatchback FWD DADA/DPCA		2611000L	Drive Shaft		36		59.5	40.5	514	
	2019.12-	7AT	F	L	Hatchback FWD DFYA		2611000L	Drive Shaft		36		59.5	40.5	514	
1.6 (66 kw)	2009.02-2012.11	5MT	F	L	Hatchback FWD CAYB		2032940L	Drive Shaft		36		59.5	40	517	
	2009.02-2012.11	5MT	F	R	Hatchback FWD CAYB		2610420L	Drive Shaft		36		59.5	40	814	
	2009.02-2012.11	5MT	F	L	Hatchback Van FWD CAYB		2032940L	Drive Shaft		36		59.5	40	517	
	2009.02-2012.11	5MT	F	R	Hatchback Van FWD CAYB		2610420L	Drive Shaft		36		59.5	40	814	
	2013.04-	5MT	F	L	Hatchback Van FWD CRKA		2032940L	Drive Shaft		36		59.5	40	517	
	2013.04-	5MT	F	R	Hatchback Van FWD CRKA		2610420L	Drive Shaft		36		59.5	40	814	
	2013.04-2018.07	5MT	F	L	Hatchback FWD CLHB/CRKA/CXXA/DDYB	Model code:5G1	2032940L	Drive Shaft		36		59.5	40	517	
	2013.04-2018.07	5MT	F	L	Hatchback FWD CLHB/CRKA/CXXA/DDYB	Model code:BQ1	2612820L	Drive Shaft		36		59.5	40	523	
	2013.04-2018.07	5MT	F	R	Hatchback FWD CLHB/CRKA/CXXA/DDYB	Model code:5G1	2610420L	Drive Shaft		36		59.5	40	814	
	2013.04-2018.07	5MT	F	R	Hatchback FWD CLHB/CRKA/CXXA/DDYB	Model code:BQ1	2612830L	Drive Shaft		36		59.5	40	815	



  YEAR	TRANSM.	F/R	L/R	BODY STYLE & DRIVE TYPE & ENGINE	REMARKS	GSP Ref.	 PRODUCT	 ABS	Technical Specifications				
									A	B	C	H	L
VW Golf													
1.6 (75 kw)													
2004.01-2008.11	AT	F	R	Hatchback FWD BGU/BSE/BSF/CCSA		2610940L	Drive Shaft		36	26	59.5	40	884
2004.01-2008.11	MT	F	R	Hatchback FWD BGU/BSE/BSF/CCSA		2610960L	Drive Shaft		36		59.5	40	800
2007.11-2008.11	5MT	F	R	Hatchback FWD CCSA		2610960L	Drive Shaft		36		59.5	40	800
2008.10-2012.11	AT	F	L	Hatchback FWD BSE/BSF/CCSA/CMXA		2032940L	Drive Shaft		36		59.5	40	517
2008.10-2012.11	AT	F	R	Hatchback FWD BSE/BSF/CCSA/CMXA		2610420L	Drive Shaft		36		59.5	40	814
2008.10-2012.11	MT	F	R	Hatchback FWD BSE/BSF/CCSA/CMXA		2610960L	Drive Shaft		36		59.5	40	800
2008.10-2012.11	5MT	F	R	Hatchback FWD CCSA/CMXA		2610960L	Drive Shaft		36		59.5	40	800
2008.10-2012.11	7AT	F	L	Hatchback FWD CCSA/CMXA		2032940L	Drive Shaft		36		59.5	40	517
2009.03-2012.11	5MT	F	R	Hatchback FWD CHGA		2610960L	Drive Shaft		36		59.5	40	800
1.6 (77 kw)													
2009.02-2012.11	7DCT	F	R	Hatchback FWD CAYC	Date to:2011.05	2033130L	Drive Shaft		36		59.5	40.5	794
2009.02-2012.11	AT	F	L	Hatchback FWD CAYC	Date To:2009.10	2611000L	Drive Shaft		36		59.5	40.5	514
2009.02-2012.11	AT	F	L	Hatchback FWD CAYC	Date From:2011.06	2612820L	Drive Shaft		36		59.5	40	523
2009.02-2012.11	AT	F	R	Hatchback FWD CAYC	Date From:2011.06	2610960L	Drive Shaft		36		59.5	40	800
2009.02-2012.11	MT	F	L	Hatchback FWD CAYC	Date To:2011.05,Date From:2011.06,For PR code:GOC	2032940L	Drive Shaft		36		59.5	40	517
2009.02-2012.11	MT	F	L	Hatchback FWD CAYC	Date From:2011.06,For PR code:GOJ	2612820L	Drive Shaft		36		59.5	40	523
2009.02-2012.11	MT	F	R	Hatchback FWD CAYC	Date To:2011.05,Date From:2011.06,For PR code:GOC	2610420L	Drive Shaft		36		59.5	40	814
2009.02-2012.11	MT	F	R	Hatchback FWD CAYC	Date From:2011.06,For PR code:GOJ	2612830L	Drive Shaft		36		59.5	40	815
2009.05-2012.11	5MT	F	R	Hatchback Van FWD CAYC		2610420L	Drive Shaft		36		59.5	40	814
2009.05-2012.11	AT	F	L	Hatchback Van FWD CAYC	Date To:2009.10	2611000L	Drive Shaft		36		59.5	40.5	514
2009.05-2012.11	AT	F	L	Hatchback Van FWD CAYC	Date From:2011.06	2612820L	Drive Shaft		36		59.5	40	523
2009.05-2012.11	AT	F	R	Hatchback Van FWD CAYC	Date To:2011.05	2033130L	Drive Shaft		36		59.5	40.5	794
2009.05-2012.11	AT	F	R	Hatchback Van FWD CAYC	Date From:2011.06	2610960L	Drive Shaft		36		59.5	40	800
2009.05-2012.11	MT	F	L	Hatchback Van FWD CAYC	Date To:2011.05,Date From:2011.06,For PR code:GOC	2032940L	Drive Shaft		36		59.5	40	517
2009.05-2012.11	MT	F	L	Hatchback Van FWD CAYC	Date From:2011.06,For PR code:GOJ	2612820L	Drive Shaft		36		59.5	40	523
2009.05-2012.11	MT	F	R	Hatchback Van FWD CAYC	Date From:2011.06,For PR code:GOJ	2612830L	Drive Shaft		36		59.5	40	815
2012.08-	5MT	F	R	Hatchback Van FWD CLHA		2610420L	Drive Shaft		36		59.5	40	814
2012.08-	5MT	F	R	Hatchback Van FWD CLHA		2612830L	Drive Shaft		36		59.5	40	815
2012.08-	5MT/7DCT	F	L	Hatchback Van FWD CLHA		2612820L	Drive Shaft		36		59.5	40	523
2012.08-	7DCT	F	R	Hatchback Van FWD CLHA		2610960L	Drive Shaft		36		59.5	40	800
2012.08-2017.03	5MT	F	R	Hatchback FWD CLHA	Inner teeth of wheel side:30	2610420L	Drive Shaft		36		59.5	40	814
2012.08-2017.03	5MT	F	R	Hatchback FWD CLHA		2612830L	Drive Shaft		36		59.5	40	815
2012.08-2017.03	7DCT	F	R	Hatchback FWD CLHA		2610960L	Drive Shaft		36		59.5	40	800
2012.08-2017.03	7DCT/5MT	F	L	Hatchback FWD CLHA		2612820L	Drive Shaft		36		59.5	40	523
1.6 (81 kw)													
2013.01-	5MT	F	R	Hatchback FWD CRKB/CXXB/DBKA		2610420L	Drive Shaft		36		59.5	40	814
2013.01-	5MT/6MT	F	R	Hatchback FWD CRKB/CXXB/DBKA		2612830L	Drive Shaft		36		59.5	40	815
2013.01-	5MT/6MT/7DCT	F	L	Hatchback FWD CRKB/CXXB/DBKA		2612820L	Drive Shaft		36		59.5	40	523
2013.01-	7DCT	F	R	Hatchback FWD CRKB/CXXB/DBKA		2610960L	Drive Shaft		36		59.5	40	800
2013.01-	AT	F	L	Hatchback FWD CRKB/CXXB/DBKA		2032940L	Drive Shaft		36		59.5	40	517
2013.11-	5MT	F	R	Hatchback Van FWD CRKB/CXXB		2610420L	Drive Shaft		36		59.5	40	814
2013.11-	6MT	F	R	Hatchback Van FWD CRKB/CXXB		2612830L	Drive Shaft		36		59.5	40	815
2013.11-	6MT/7DCT	F	L	Hatchback Van FWD CRKB/CXXB		2612820L	Drive Shaft		36		59.5	40	523
2013.11-	7DCT	F	R	Hatchback Van FWD CRKB/CXXB		2610960L	Drive Shaft		36		59.5	40	800
2014.05-2017.03	5MT	F	R	Hatchback FWD CWVA		2610960L	Drive Shaft		36		59.5	40	800
2014.05-2017.03	MT	F	L	Hatchback FWD CWVA		2033730L	Drive Shaft		36		59.5	40	517
1.6 (85 kw)													
2003.10-2008.07	AT	F	R	Hatchback FWD BAG/BLF/BLP	Chassis no. to:1K5600000	2610940L	Drive Shaft		36	26	59.5	40	884
2003.10-2008.07	MT	F	R	Hatchback FWD BAG/BLF/BLP		2612110L	Drive Shaft		36		59.5	40.5	784
2016.11-	5MT	F	R	Hatchback FWD DDYA/DGTE		2610420L	Drive Shaft		36		59.5	40	814
2016.11-	5MT	F	R	Hatchback FWD DDYA/DGTE		2612830L	Drive Shaft		36		59.5	40	815
2016.11-	5MT/7DCT	F	L	Hatchback FWD DDYA/DGTE		2612820L	Drive Shaft		36		59.5	40	523
2016.11-	7DCT	F	R	Hatchback FWD DDYA/DGTE		2610960L	Drive Shaft		36		59.5	40	800
1.8 (118 kw)													
2009.06-2011.01	7AT	F	L	Hatchback FWD CDAA		2033800L	Drive Shaft		36		59.5	40	487
2009.06-2011.01	AT	F	R	Hatchback FWD CDAA		2033130L	Drive Shaft		36		59.5	40.5	794
2009.06-2011.01	AT	F	R	Hatchback FWD CDAA		2610940L	Drive Shaft		36	26	59.5	40	884
2009.06-2011.01	AT/MT	F	L	Hatchback FWD CDAA		2611000L	Drive Shaft		36		59.5	40.5	514
2009.06-2011.01	MT	F	R	Hatchback FWD CDAA		2613410L	Drive Shaft		36		59.5	40.5	806
1.9 (66 kw)													
2004.05-2008.11	5MT	F	L	Hatchback FWD BRU/BXF/BXJ		2032940L	Drive Shaft		36		59.5	40	517
2004.05-2008.11	5MT	F	R	Hatchback FWD BRU/BXF/BXJ		2610420L	Drive Shaft		36		59.5	40	814
1.9 (77 kw)													
2003.10-2007.07	6MT	F	L	Hatchback 4WD BKC		2032950L	Drive Shaft		36		59.5	40.5	486
2003.10-2007.07	6MT	F	R	Hatchback 4WD BKC		2032660L	Drive Shaft		36		59.5	40.5	601
2003.10-2008.11	5MT/6MT	F	L	Hatchback FWD BKC/BLS/BXE		2032940L	Drive Shaft		36		59.5	40	517
2003.10-2008.11	5MT/6MT	F	R	Hatchback FWD BKC/BLS/BXE		2610420L	Drive Shaft		36		59.5	40	814
2003.10-2008.11	6DCT	F	L	Hatchback FWD BKC/BLS/BXE	Date from:2008.01,For driving school cars	2033810L	Drive Shaft		36		59.5	40	485
2003.10-2008.11	6DCT	F	L	Hatchback FWD BKC/BLS/BXE	Date to:2007.12,For driving school cars	2540130L	Drive Shaft		36		59.5	40.5	482
2003.10-2008.11	6DCT	F	R	Hatchback FWD BKC/BLS/BXE		2033540L	Drive Shaft		36		59.5	40	760
2003.10-2008.11	6DCT	F	R	Hatchback FWD BKC/BLS/BXE		2540110L	Drive Shaft		36		59.5	40.5	760



 YEAR	TRANSM.	F/R	L/R	BODY STYLE & DRIVE TYPE & ENGINE	REMARKS	GSP Ref.	 PRODUCT	 ABS	Technical Specifications						
									A	B	C	H	L		
VW Golf															
1.9 (110 kw)	2000.09-2004.05	6MT	F	L	Hatchback FWD ARL		2033800L	Drive Shaft		36		59.5	40	487	
2.0 (55 kw)	2004.01-2008.11	5MT	F	R	Hatchback FWD BDK		2610960L	Drive Shaft		36		59.5	40	800	
2.0 (81 kw)	2008.10-2012.11	AT	F	L	Hatchback FWD CBDC/CLCA		2540130L	Drive Shaft		36		59.5	40.5	482	
	2008.10-2012.11	AT	F	R	Hatchback FWD CBDC/CLCA		2540110L	Drive Shaft		36		59.5	40.5	760	
	2008.10-2012.11	MT	F	L	Hatchback FWD CBDC/CLCA		2032940L	Drive Shaft		36		59.5	40	517	
	2008.10-2012.11	MT	F	R	Hatchback FWD CBDC/CLCA		2610420L	Drive Shaft		36		59.5	40	814	
	2012.11-	5MT	F	R	Hatchback FWD CRVA/CYKB/DCYB/DEJB/DFGB		2610420L	Drive Shaft		36		59.5	40	814	
	2012.11-	5MT	F	R	Hatchback FWD CRVA/CYKB/DCYB/DEJB/DFGB		2612830L	Drive Shaft		36		59.5	40	815	
	2012.11-	5MT/7DCT	F	L	Hatchback FWD CRVA/CYKB/DCYB/DEJB/DFGB		2612820L	Drive Shaft		36		59.5	40	523	
	2012.11-	6DCT	F	L	Hatchback FWD CRVA/CYKB/DCYB/DEJB/DFGB		2612850L	Drive Shaft		36		59.5	40	472	
	2012.11-	6DCT	F	R	Hatchback FWD CRVA/CYKB/DCYB/DEJB/DFGB		2033540L	Drive Shaft		36		59.5	40	760	
	2012.11-	7DCT	F	R	Hatchback FWD CRVA/CYKB/DCYB/DEJB/DFGB		2610960L	Drive Shaft		36		59.5	40	800	
2012.11-	MT/7AT	F	L	Hatchback FWD CRVA/CYKB/DCYB/DEJB/DFGB		2032940L	Drive Shaft		36		59.5	40	517		
2.0 (85 kw)	2005.01-2008.10	5MT	F	R	Hatchback FWD BHY	For Engine Code:BHY	2610420L	Drive Shaft		36		59.5	40	814	
2.0 (100 kw)	2003.10-2008.11	6DCT	F	L	Hatchback FWD AZV	Date To:2008.01.For driving school cars	2033810L	Drive Shaft		36		59.5	40	485	
	2003.10-2008.11	6DCT	F	L	Hatchback FWD AZV	Date To:2007.12.For driving school cars	2540130L	Drive Shaft		36		59.5	40.5	482	
	2003.10-2008.11	6DCT	F	R	Hatchback FWD AZV	For driving school cars	2540110L	Drive Shaft		36		59.5	40.5	760	
	2003.10-2008.11	6MT	F	L	Hatchback FWD AZV	Date From:2004.11.For driving school cars	2032950L	Drive Shaft		36		59.5	40.5	486	
	2003.10-2008.11	6MT	F	R	Hatchback FWD AZV	Date From:2004.11.For driving school cars	2033130L	Drive Shaft		36		59.5	40.5	794	
	2003.10-2008.11	6MT	F	R	Hatchback FWD AZV	For driving school cars	2611470L	Drive Shaft		36		59.5	40.5	795	
	2003.10-2008.11	MT	F	R	Hatchback FWD AZV		2033800L	Drive Shaft		36		59.5	40	487	
	2008.10-2012.11	6MT	F	L	Hatchback FWD CBAA/CFFA	Rims:With alloy rim	2032950L	Drive Shaft		36		59.5	40.5	486	
	2008.10-2012.11	6MT	F	L	Hatchback FWD CBAA/CFFA	Rims:With steel rim	2033800L	Drive Shaft		36		59.5	40	487	
	2008.10-2012.11	6MT	F	R	Hatchback FWD CBAA/CFFA		2033130L	Drive Shaft		36		59.5	40.5	794	
2008.10-2012.11	MT	F	L	Hatchback FWD CBAA/CFFA		2033800L	Drive Shaft		36		59.5	40	487		
2.0 (103 kw)	2003.10-2008.11	6AT	F	L	Hatchback FWD BKD		2540130L	Drive Shaft		36		59.5	40.5	482	
	2003.10-2008.11	6AT	F	R	Hatchback FWD BKD		2540110L	Drive Shaft		36		59.5	40.5	760	
	2003.10-2008.11	6DCT	F	L	Hatchback FWD BKD	Date From:2008.01.For driving school cars	2033810L	Drive Shaft		36		59.5	40	485	
	2003.10-2008.11	6MT	F	L	Hatchback FWD BKD		2032950L	Drive Shaft		36		59.5	40.5	486	
	2003.10-2008.11	6MT	F	R	Hatchback FWD BKD	Date From:2004.11	2033130L	Drive Shaft		36		59.5	40.5	794	
	2003.10-2008.11	6MT	F	R	Hatchback FWD BKD	For driving school cars	2611470L	Drive Shaft		36		59.5	40.5	795	
	2003.10-2008.11	MT	F	R	Hatchback FWD BKD		2033800L	Drive Shaft		36		59.5	40	487	
	2004.08-2008.11	6MT	F	L	Hatchback 4WD BKD		2032950L	Drive Shaft		36		59.5	40.5	486	
	2004.08-2008.11	6MT	F	R	Hatchback 4WD BKD		2032660L	Drive Shaft		36		59.5	40.5	601	
	2004.12-2008.11	6DCT	F	L	Hatchback FWD BMM	Date From:2008.01.For driving school cars	2033810L	Drive Shaft		36		59.5	40	485	
	2004.12-2008.11	6DCT	F	L	Hatchback FWD BMM	Date To:2007.12.For driving school cars	2540130L	Drive Shaft		36		59.5	40.5	482	
	2004.12-2008.11	6DCT	F	R	Hatchback FWD BMM	For driving school cars	2540110L	Drive Shaft		36		59.5	40.5	760	
	2004.12-2008.11	6MT	F	L	Hatchback FWD BMM		2032950L	Drive Shaft		36		59.5	40.5	486	
	2004.12-2008.11	6MT	F	R	Hatchback FWD BMM		2033130L	Drive Shaft		36		59.5	40.5	794	
	2004.12-2008.11	6MT	F	R	Hatchback FWD BMM	For driving school cars	2611470L	Drive Shaft		36		59.5	40.5	795	
	2004.12-2008.11	MT	F	L	Hatchback FWD BMM		2033800L	Drive Shaft		36		59.5	40	487	
	2007.01-2008.11	6MT	F	L	Hatchback 4WD BMM		2032950L	Drive Shaft		36		59.5	40.5	486	
	2007.01-2008.11	6MT	F	R	Hatchback 4WD BMM		2032660L	Drive Shaft		36		59.5	40.5	601	
	2007.01-2008.11	MT	F	L	Hatchback 4WD BMM		2033800L	Drive Shaft		36		59.5	40	487	
	2008.10-2012.11	MT	F	L	Hatchback 4WD CBAB/CFFB		2032950L	Drive Shaft		36		59.5	40.5	486	
	2008.10-2012.11	MT	F	L	Hatchback 4WD CBAB/CFFB		2033800L	Drive Shaft		36		59.5	40	487	
	2008.10-2012.11	MT	F	R	Hatchback 4WD CBAB/CFFB		2032660L	Drive Shaft		36		59.5	40.5	601	
	2008.10-2012.11	AT	F	L	Hatchback FWD CBAB/CFFB/CJAA		2540130L	Drive Shaft		36		59.5	40.5	482	
	2008.10-2012.11	AT	F	R	Hatchback FWD CBAB/CFFB/CJAA		2540110L	Drive Shaft		36		59.5	40.5	760	
	2008.10-2012.11	MT	F	L	Hatchback FWD CBAB/CFFB/CJAA	Rims:With alloy rim	2032950L	Drive Shaft		36		59.5	40.5	486	
	2008.10-2012.11	MT	F	L	Hatchback FWD CBAB/CFFB/CJAA	Rims:With steel rim	2033800L	Drive Shaft		36		59.5	40	487	
	2008.10-2012.11	MT	F	L	Hatchback FWD CBAB/CFFB/CJAA		2033800L	Drive Shaft		36		59.5	40	487	
	2008.10-2012.11	MT	F	R	Hatchback FWD CBAB/CFFB/CJAA		2033130L	Drive Shaft		36		59.5	40.5	794	
	2009.09-2012.11	AT	F	L	Hatchback Van FWD CFFB/CJAA		2540130L	Drive Shaft		36		59.5	40.5	482	
	2009.09-2012.11	AT	F	R	Hatchback Van FWD CFFB/CJAA		2540110L	Drive Shaft		36		59.5	40.5	760	
2009.09-2012.11	MT	F	L	Hatchback Van FWD CFFB/CJAA	Rims:With alloy rim	2032950L	Drive Shaft		36		59.5	40.5	486		
2009.09-2012.11	MT	F	R	Hatchback Van FWD CFFB/CJAA		2033130L	Drive Shaft		36		59.5	40.5	794		
2.0 (105 kw)	2012.08-	6DCT	F	L	Hatchback FWD CRBB/CRVC		2612850L	Drive Shaft		36		59.5	40	472	
	2012.08-	6DCT	F	R	Hatchback FWD CRBB/CRVC		2033540L	Drive Shaft		36		59.5	40	760	
	2012.08-	6MT	F	R	Hatchback FWD CRBB/CRVC		2033130L	Drive Shaft		36		59.5	40.5	794	
2.0 (110 kw)	2003.10-2008.11	AT	F	R	Hatchback FWD AXW/BLR/BLX/BLV/BVX/BVY/BVZ		2610940L	Drive Shaft		36	26	59.5	40	884	
	2003.10-2008.11	MT	F	L	Hatchback FWD AXW/BLR/BLX/BLV/BVX/BVY/BVZ		2032940L	Drive Shaft		36		59.5	40	517	
	2003.10-2008.11	MT	F	R	Hatchback FWD AXW/BLR/BLX/BLV/BVX/BVY/BVZ		2610420L	Drive Shaft		36		59.5	40	814	
	2005.05-2008.11	6MT	F	L	Hatchback 4WD BLX/BVX		2032940L	Drive Shaft		36		59.5	40	517	
	2005.05-2008.11	6MT	F	R	Hatchback 4WD BLX/BVX		2610960L	Drive Shaft		36		59.5	40	800	

	 YEAR	TRANSM.	F/R	L/R	BODY STYLE & DRIVE TYPE & ENGINE	REMARKS	GSP Ref.	 PRODUCT ABS	Technical Specifications						
									A	B	C	H	L		
VW Golf															
2.0 (110 kw)	2005.05-2008.11	AT	F	R	Hatchback 4WD BLX/BVX		2610940L	Drive Shaft	36	26	59.5	40	884		
	2005.05-2008.11	MT	F	R	Hatchback 4WD BLX/BVX		2610420L	Drive Shaft	36		59.5	40	814		
	2012.08-	6DCT	F	L	Hatchback FWD CRBC/CRLB/CRMB/DCYA/DEJA/DFGA		2612850L	Drive Shaft	36		59.5	40	472		
	2012.08-	6DCT	F	R	Hatchback FWD CRBC/CRLB/CRMB/DCYA/DEJA/DFGA		2033540L	Drive Shaft	36		59.5	40	760		
	2012.08-	6MT	F	L	Hatchback FWD CRBC/CRLB/CRMB/DCYA/DEJA/DFGA	For PR code:F4E/F4F/F5Z/F6U,For taxis	2032950L	Drive Shaft	36		59.5	40.5	486		
	2012.08-	6MT	F	R	Hatchback FWD CRBC/CRLB/CRMB/DCYA/DEJA/DFGA		2033130L	Drive Shaft	36		59.5	40.5	794		
	2012.08-	7DCT	F	L	Hatchback FWD CRBC/CRLB/CRMB/DCYA/DEJA/DFGA		2012650L	Drive Shaft	36	37	59.5	40	558		
	2012.11-2020.08	7DCT	F	L	Hatchback 4WD CKFC/CRBC/CRLB/CRMB/DCYA		2012650L	Drive Shaft	36	37	59.5	40	558		
	2019.08-	7DCT	F	L	Hatchback FWD DSRB/DTSAD/TSSB/DTTA/DTTC	For PR code:0IJ	2012650L	Drive Shaft	36	37	59.5	40	558		
	2019.08-	7DCT	F	L	Hatchback FWD DSRB/DTSAD/TSSB/DTTA/DTTC	For PR code:0EG	2612820L	Drive Shaft	36		59.5	40	523		
2.0 (125 kw)	2005.11-2008.11	6DCT	F	L	Hatchback FWD BMN	Date From:2008.01,For driving school cars	2033810L	Drive Shaft	36		59.5	40	485		
	2005.11-2008.11	6DCT	F	L	Hatchback FWD BMN	Date To:2007.12,For driving school cars	2540130L	Drive Shaft	36		59.5	40.5	482		
	2005.11-2008.11	6DCT	F	R	Hatchback FWD BMN	For driving school cars	2540110L	Drive Shaft	36		59.5	40.5	760		
	2005.11-2008.11	6MT	F	R	Hatchback FWD BMN	For driving school cars	2033130L	Drive Shaft	36		59.5	40.5	794		
	2005.11-2008.11	6MT	F	R	Hatchback FWD BMN	For driving school cars	2611470L	Drive Shaft	36		59.5	40.5	795		
	2005.11-2008.11	MT	F	L	Hatchback FWD BMN		2032950L	Drive Shaft	36		59.5	40.5	486		
	2005.11-2008.11	MT	F	L	Hatchback FWD BMN		2033800L	Drive Shaft	36		59.5	40	487		
	2009.04-2012.11	6MT	F	R	Hatchback FWD CBBB/CFGB	For driving school cars	2611470L	Drive Shaft	36		59.5	40.5	795		
	2009.04-2012.11	AT	F	L	Hatchback FWD CBBB/CFGB		2033810L	Drive Shaft	36		59.5	40	485		
	2009.04-2012.11	AT	F	L	Hatchback FWD CBBB/CFGB	Rims:with light alloy rim	2540130L	Drive Shaft	36		59.5	40.5	482		
	2009.04-2012.11	AT	F	R	Hatchback FWD CBBB/CFGB		2540110L	Drive Shaft	36		59.5	40.5	760		
	2009.04-2012.11	MT	F	L	Hatchback FWD CBBB/CFGB		2032950L	Drive Shaft	36		59.5	40.5	486		
	2009.04-2012.11	MT	F	L	Hatchback FWD CBBB/CFGB		2033800L	Drive Shaft	36		59.5	40	487		
	2009.04-2012.11	MT	F	R	Hatchback FWD CBBB/CFGB		2033130L	Drive Shaft	36		59.5	40.5	794		
	2010.05-2012.11	6MT	F	R	Hatchback Van FWD CFGB	For driving school cars	2033130L	Drive Shaft	36		59.5	40.5	794		
	2010.05-2012.11	6MT	F	R	Hatchback Van FWD CFGB	For driving school cars	2611470L	Drive Shaft	36		59.5	40.5	795		
	2010.05-2012.11	AT	F	L	Hatchback Van FWD CFGB	Rims:With alloy rim	2033810L	Drive Shaft	36		59.5	40	485		
	2010.05-2012.11	AT	F	L	Hatchback Van FWD CFGB	Rims:With steel rim	2540130L	Drive Shaft	36		59.5	40.5	482		
	2010.05-2012.11	AT	F	R	Hatchback Van FWD CFGB		2540110L	Drive Shaft	36		59.5	40.5	760		
	2010.05-2012.11	MT	F	L	Hatchback Van FWD CFGB	With steel rim;With alloy rim	2032950L	Drive Shaft	36		59.5	40.5	486		
2.0 (135 kw)	2013.04-	6DCT	F	L	Hatchback FWD CUNA/DGCA/DJGA		2612850L	Drive Shaft	36		59.5	40	472		
	2013.04-	6DCT	F	R	Hatchback FWD CUNA/DGCA/DJGA		2033540L	Drive Shaft	36		59.5	40	760		
	2013.04-	6MT	F	L	Hatchback FWD CUNA/DGCA/DJGA		2032950L	Drive Shaft	36		59.5	40.5	486		
	2013.04-	7DCT	F	L	Hatchback FWD CUNA/DGCA/DJGA		2012650L	Drive Shaft	36	37	59.5	40	558		
	2013.04-	6DCT	F	L	Hatchback Van FWD CUNA		2612850L	Drive Shaft	36		59.5	40	472		
	2013.04-	6DCT	F	R	Hatchback Van FWD CUNA		2033540L	Drive Shaft	36		59.5	40	760		
2.0 (147 kw)	2004.08-2009.02	6DCT	F	L	Hatchback FWD AXX/BPY/BWA/CAWB/CBFA	Trans. code:HRW	2033800L	Drive Shaft	36		59.5	40	487		
	2004.08-2009.02	AT	F	L	Hatchback FWD AXX/BPY/BWA/CAWB/CBFA	Trans. code:HRW	2032950L	Drive Shaft	36		59.5	40.5	486		
	2004.08-2009.02	AT	F	L	Hatchback FWD AXX/BPY/BWA/CAWB/CBFA	Trans. code:HBQ	2540130L	Drive Shaft	36		59.5	40.5	482		
	2004.08-2009.02	AT	F	R	Hatchback FWD AXX/BPY/BWA/CAWB/CBFA		2016530L	Drive Shaft	36		59.5	40.5	785		
	2004.08-2009.02	AT/MT	F	L	Hatchback FWD AXX/BPY/BWA/CAWB/CBFA		2033800L	Drive Shaft	36		59.5	40	487		
	2004.08-2009.02	MT	F	L	Hatchback FWD AXX/BPY/BWA/CAWB/CBFA		2032950L	Drive Shaft	36		59.5	40.5	486		
	2009.07-2013.11	AT	F	R	Hatchback FWD CBFA/CCTA		2016530L	Drive Shaft	36		59.5	40.5	785		
	2009.07-2013.11	AT/MT	F	L	Hatchback FWD CBFA/CCTA		2032950L	Drive Shaft	36		59.5	40.5	486		
	2009.07-2013.11	MT	F	R	Hatchback FWD CBFA/CCTA		2611470L	Drive Shaft	36		59.5	40.5	795		
2.0 (155 kw)	2009.02-2012.11	AT	F	R	Hatchback FWD CCZB		2016530L	Drive Shaft	36		59.5	40.5	785		
	2009.02-2012.11	MT	F	L	Hatchback FWD CCZB	Date To:2009.12	2032950L	Drive Shaft	36		59.5	40.5	486		
	2009.02-2012.11	MT	F	L	Hatchback FWD CCZB		2033800L	Drive Shaft	36		59.5	40	487		
	2009.02-2012.11	MT	F	R	Hatchback FWD CCZB	Date From:2010.01	2611470L	Drive Shaft	36		59.5	40.5	795		
	2009.02-2012.11	AT	F	R	Hatchback Van FWD CCZB		2016530L	Drive Shaft	36		59.5	40.5	785		
	2009.02-2012.11	MT	F	L	Hatchback Van FWD CCZB		2032950L	Drive Shaft	36		59.5	40.5	486		
	2009.02-2012.11	MT	F	R	Hatchback Van FWD CCZB		2611470L	Drive Shaft	36		59.5	40.5	795		
2.0 (169 kw)	2006.09-2008.12	6DCT	F	L	Hatchback FWD BYD		2033800L	Drive Shaft	36		59.5	40	487		
	2006.09-2008.12	6DCT	F	R	Hatchback FWD BYD		2016530L	Drive Shaft	36		59.5	40.5	785		
	2006.09-2008.12	6MT/6DCT	F	L	Hatchback FWD BYD		2032950L	Drive Shaft	36		59.5	40.5	486		
	2013.04-	6MT	F	R	Hatchback FWD CHIHA	For vehicles with electronic LTD slip differential,Date From:2016.03	2033130L	Drive Shaft	36		59.5	40.5	794		
2.0 (173 kw)	2011.05-2012.11	MT	F	R	Hatchback FWD CDLG		2611470L	Drive Shaft	36		59.5	40.5	795		
	2011.05-2012.11		F	L	Hatchback FWD CDLG		2033800L	Drive Shaft	36		59.5	40	487		
2.0 (188 kw)	2009.11-2012.11	AT/MT	F	L	Hatchback 4WD CDLC		2033800L	Drive Shaft	36		59.5	40	487		
2.0 (195 kw)	2009.11-2011.05	AT/MT	F	L	Hatchback 4WD CDLA		2033800L	Drive Shaft	36		59.5	40	487		
2.0 (199 kw)	2009.11-2012.11	AT/MT	F	L	Hatchback 4WD CDLF		2033800L	Drive Shaft	36		59.5	40	487		
2.5 (125 kw)	2009.07-2013.05	MT	F	L	Hatchback FWD CBTA/CBUA		2032940L	Drive Shaft	36		59.5	40	517		
	2009.07-2013.05	MT	F	R	Hatchback FWD CBTA/CBUA		2612830L	Drive Shaft	36		59.5	40	815		
3.2 (184 kw)	2005.05-2008.11	AT/MT	F	R	Hatchback 4WD BUB/CBRA		2032660L	Drive Shaft	36		59.5	40.5	601		
	2005.05-2008.11	MT	F	L	Hatchback 4WD BUB/CBRA		2032950L	Drive Shaft	36		59.5	40.5	486		



 YEAR	TRANSM.	F/R	L/R	BODY STYLE & DRIVE TYPE & ENGINE	REMARKS	GSP Ref.	 PRODUCT ABS	Technical Specifications				
								A	B	C	H	L
VW Golf												
3.2 (184 kw)	2005.05-2008.11	MT	F	L	Hatchback 4WD BUB/CBRA	2033800L	Drive Shaft	36	59.5	40	487	
Golf Alltrack												
1.6 (81 kw)	2014.12-2017.03	MT	F	L	Estate 4WD CRKB/CXXB	2032940L	Drive Shaft	36	59.5	40	517	
2.0 (110 kw)	2014.12-2018.05	MT	F	L	Estate 4WD CRBC/CRLB/DCYA	2032940L	Drive Shaft	36	59.5	40	517	
2.0 (135 kw)	2014.12-	6DCT	F	L	Estate 4WD CUNA/DGCA/DJGA	2612850L	Drive Shaft	36	59.5	40	472	
Golf Cabrio												
1.2 (77 kw)	2011.03-2016.05	MT	F	L	Cabriolet FWD CBZB	2612010L	Drive Shaft	36	59.5	40	536	
	2011.03-2016.05	MT	F	R	Cabriolet FWD CBZB	2610960L	Drive Shaft	36	59.5	40	800	
	2013.11-2016.05	AT	F	R	Cabriolet FWD CJZA/CYVD	Date From:2014.01 2610960L	Drive Shaft	36	59.5	40	800	
	2013.11-2016.05	MT	F	L	Cabriolet FWD CJZA/CYVD	Date From:2014.01 2032940L	Drive Shaft	36	59.5	40	517	
	2013.11-2016.05	MT	F	L	Cabriolet FWD CJZA/CYVD	2033730L	Drive Shaft	36	59.5	40	517	
	2013.11-2016.05	MT	F	R	Cabriolet FWD CJZA/CYVD	Date From:2014.01 2610420L	Drive Shaft	36	59.5	40	814	
	2013.11-2016.05	MT	F	R	Cabriolet FWD CJZA/CYVD	2613070L	Drive Shaft	36	59.5	40	820	
1.4 (90 kw)	2011.11-2016.05	AT/MT	F	L	Cabriolet FWD CAXA	2612010L	Drive Shaft	36	59.5	40	536	
	2011.11-2016.05	AT/MT	F	R	Cabriolet FWD CAXA	2610960L	Drive Shaft	36	59.5	40	800	
1.4 (110 kw)	2013.11-2016.05	DCT	F	L	Cabriolet FWD CHPB/CZDA	2611000L	Drive Shaft	36	59.5	40.5	514	
	2013.11-2016.05	MT	F	L	Cabriolet FWD CHPB/CZDA	2612820L	Drive Shaft	36	59.5	40	523	
	2013.11-2016.05	MT	F	R	Cabriolet FWD CHPB/CZDA	2612830L	Drive Shaft	36	59.5	40	815	
1.4 (118 kw)	2011.03-2016.05	AT	F	L	Cabriolet FWD CAVD/CNWA/CTHD/CTKA	2612810L	Drive Shaft	36	59.5	40.5	525	
	2011.03-2016.05	AT	F	R	Cabriolet FWD CAVD/CNWA/CTHD/CTKA	2016530L	Drive Shaft	36	59.5	40.5	785	
	2011.03-2016.05	MT	F	L	Cabriolet FWD CAVD/CNWA/CTHD/CTKA	2612010L	Drive Shaft	36	59.5	40	536	
	2011.03-2016.05	MT	F	R	Cabriolet FWD CAVD/CNWA/CTHD/CTKA	2610960L	Drive Shaft	36	59.5	40	800	
1.6 (77 kw)	2011.03-2016.05	5MT	F	L	Cabriolet FWD CAYC	2032940L	Drive Shaft	36	59.5	40	517	
	2011.03-2016.05	5MT	F	R	Cabriolet FWD CAYC	2610420L	Drive Shaft	36	59.5	40	814	
2.0 (81 kw)	2013.11-2016.05	MT	F	L	Cabriolet FWD CUUA	2032940L	Drive Shaft	36	59.5	40	517	
	2013.11-2016.05	MT	F	R	Cabriolet FWD CUUA	2610420L	Drive Shaft	36	59.5	40	814	
2.0 (103 kw)	2011.11-2016.05	AT	F	L	Cabriolet FWD CFHC	2540130L	Drive Shaft	36	59.5	40.5	482	
	2011.11-2016.05	AT	F	R	Cabriolet FWD CFHC	2540110L	Drive Shaft	36	59.5	40.5	760	
	2011.11-2016.05	MT	F	L	Cabriolet FWD CFHC	Rims:With alloy rim 2032950L	Drive Shaft	36	59.5	40.5	486	
	2011.11-2016.05	MT	F	L	Cabriolet FWD CFHC	Rims:With steel rim 2033800L	Drive Shaft	36	59.5	40	487	
	2011.11-2016.05	MT	F	L	Cabriolet FWD CFHC	2033800L	Drive Shaft	36	59.5	40	487	
	2011.11-2016.05	MT	F	R	Cabriolet FWD CFHC	2033130L	Drive Shaft	36	59.5	40.5	794	
2.0 (110 kw)	2013.11-2016.05	DCT	F	L	Cabriolet FWD CUUB	2033810L	Drive Shaft	36	59.5	40	485	
	2013.11-2016.05	DCT	F	L	Cabriolet FWD CUUB	2540130L	Drive Shaft	36	59.5	40.5	482	
	2013.11-2016.05	DCT	F	R	Cabriolet FWD CUUB	2540110L	Drive Shaft	36	59.5	40.5	760	
	2013.11-2016.05	MT	F	L	Cabriolet FWD CUUB	2032950L	Drive Shaft	36	59.5	40.5	486	
	2013.11-2016.05	MT	F	R	Cabriolet FWD CUUB	2033130L	Drive Shaft	36	59.5	40.5	794	
	2013.11-2016.05	MT	F	R	Cabriolet FWD CUUB	2611470L	Drive Shaft	36	59.5	40.5	795	
2.0 (155 kw)	2012.05-2016.05	AT	F	L	Cabriolet FWD CCZB	2032950L	Drive Shaft	36	59.5	40.5	486	
	2012.05-2016.05	MT	F	R	Cabriolet FWD CCZB	2611470L	Drive Shaft	36	59.5	40.5	795	
	2012.05-2016.05		F	L	Cabriolet FWD CCZB	2033800L	Drive Shaft	36	59.5	40	487	
2.0 (195 kw)	2013.01-2016.05	MT	F	L	Cabriolet FWD CDLA	2033800L	Drive Shaft	36	59.5	40	487	
Golf Estate/Variant												
1.2 (63 kw)	2010.07-2013.07	AT/MT	F	L	Estate FWD CBZA	2612010L	Drive Shaft	36	59.5	40	536	
	2010.07-2013.07	MT	F	R	Estate FWD CBZA	2610960L	Drive Shaft	36	59.5	40	800	
	2013.05-2017.03	5MT	F	R	Estate FWD CJZB/CYVA	2610960L	Drive Shaft	36	59.5	40	800	
	2013.05-2017.03	MT	F	L	Estate FWD CJZB/CYVA	2032940L	Drive Shaft	36	59.5	40	517	
	2013.05-2017.03	MT	F	L	Estate FWD CJZB/CYVA	Date To:2017.03/For PR code:1PE/1PF/For PR code:0EC 2033730L	Drive Shaft	36	59.5	40	517	
	2013.05-2017.03	MT	F	R	Estate FWD CJZB/CYVA	2610420L	Drive Shaft	36	59.5	40	814	
1.2 (77 kw)	2009.08-2013.07	6MT	F	R	Estate FWD CBZB	2610960L	Drive Shaft	36	59.5	40	800	
	2009.08-2013.07	AT	F	R	Estate FWD CBZB	2016530L	Drive Shaft	36	59.5	40.5	785	
	2009.08-2013.07	AT/MT	F	L	Estate FWD CBZB	2612010L	Drive Shaft	36	59.5	40	536	
	2013.04-2017.03	6MT	F	L	Estate FWD CJZA	2033730L	Drive Shaft	36	59.5	40	517	
	2013.04-2017.03	6MT	F	R	Estate FWD CJZA	2613070L	Drive Shaft	36	59.5	40	820	
	2013.04-2017.03	7DCT	F	L	Estate FWD CJZA	2612820L	Drive Shaft	36	59.5	40	523	
	2013.04-2017.03	7DCT	F	R	Estate FWD CJZA	2610960L	Drive Shaft	36	59.5	40	800	
	2013.04-2017.03	MT	F	L	Estate FWD CJZA	2032940L	Drive Shaft	36	59.5	40	517	
	2013.04-2017.03	MT	F	R	Estate FWD CJZA	2610420L	Drive Shaft	36	59.5	40	814	
1.2 (81 kw)	2014.05-2017.03	6MT	F	L	Estate FWD CYVB	2033730L	Drive Shaft	36	59.5	40	517	
	2014.05-2017.03	6MT	F	R	Estate FWD CYVB	2613070L	Drive Shaft	36	59.5	40	820	
	2014.05-2017.03	7DCT	F	L	Estate FWD CYVB	2612820L	Drive Shaft	36	59.5	40	523	
	2014.05-2017.03	7DCT	F	R	Estate FWD CYVB	2610960L	Drive Shaft	36	59.5	40	800	
1.4 (81 kw)	2013.05-	6MT	F	R	Estate FWD CPWA	2613070L	Drive Shaft	36	59.5	40	820	
	2013.05-	6MT/7DCT	F	L	Estate FWD CPWA	2612820L	Drive Shaft	36	59.5	40	523	
	2013.05-	7DCT	F	R	Estate FWD CPWA	2610960L	Drive Shaft	36	59.5	40	800	





 YEAR	TRANSM.	F/R	L/R	BODY STYLE & DRIVE TYPE & ENGINE	REMARKS	GSP Ref.	 PRODUCT	 ABS	Technical Specifications					
									A	B	C	H	L	
VW														
Golf Estate/Variant														
1.4 (81 kw)	2013.05-	MT/7AT	F	L	Estate FWD CPWA		2032940L	Drive Shaft		36		59.5	40	517
1.4 (90 kw)	2007.07-2009.07	6MT	F	R	Estate FWD CAXA		2610960L	Drive Shaft		36		59.5	40	800
	2007.07-2009.07	7DCT	F	R	Estate FWD CAXA	Date From:2008.12,Chassis no. from:1K9295791	2016530L	Drive Shaft		36		59.5	40.5	785
	2007.07-2009.07	MT	F	L	Estate FWD CAXA		2612010L	Drive Shaft		36		59.5	40	536
	2009.07-2013.07	7AT	F	L	Estate FWD CAXA		2612810L	Drive Shaft		36		59.5	40.5	525
	2009.07-2013.07	AT	F	R	Estate FWD CAXA		2016530L	Drive Shaft		36		59.5	40.5	785
	2009.07-2013.07	MT	F	L	Estate FWD CAXA		2612010L	Drive Shaft		36		59.5	40	536
	2009.07-2013.07	MT	F	R	Estate FWD CAXA		2610960L	Drive Shaft		36		59.5	40	800
	2013.04-2017.03	6MT	F	L	Estate FWD CPVA		2612820L	Drive Shaft		36		59.5	40	523
	2013.04-2017.03	6MT	F	R	Estate FWD CPVA		2613070L	Drive Shaft		36		59.5	40	820
	2013.04-2017.03	7AT	F	L	Estate FWD CPVA		2032940L	Drive Shaft		36		59.5	40	517
	2013.04-2017.03	AT	F	R	Estate FWD CPVA		2610960L	Drive Shaft		36		59.5	40	800
	2013.05-2017.03	6MT	F	R	Estate FWD CXSA		2613070L	Drive Shaft		36		59.5	40	820
	2013.05-2017.03	6MT/7DCT	F	L	Estate FWD CXSA		2612820L	Drive Shaft		36		59.5	40	523
	2013.05-2017.03	7DCT	F	R	Estate FWD CXSA		2610960L	Drive Shaft		36		59.5	40	800
	2013.05-2017.03	AT	F	L	Estate FWD CXSA		2612010L	Drive Shaft		36		59.5	40	536
1.4 (92 kw)	2014.05-	6MT	F	L	Estate FWD CZCA/CZDD		2612820L	Drive Shaft		36		59.5	40	523
	2014.05-	6MT	F	R	Estate FWD CZCA/CZDD		2613070L	Drive Shaft		36		59.5	40	820
	2014.05-	7DCT	F	L	Estate FWD CZCA/CZDD	For PR code:7GR,Exhaust Emission no.:Euro 5	2611000L	Drive Shaft		36		59.5	40.5	514
	2014.05-	7DCT	F	R	Estate FWD CZCA/CZDD	For PR code:7GR,Exhaust Emission no.:Euro 5	2033130L	Drive Shaft		36		59.5	40.5	794
	2014.05-	7DCT	F	R	Estate FWD CZCA/CZDD		2610960L	Drive Shaft		36		59.5	40	800
	2014.05-	MT/7AT	F	L	Estate FWD CZCA/CZDD		2032940L	Drive Shaft		36		59.5	40	517
	2014.05-2017.03	6MT	F	L	Estate FWD CPVB		2612820L	Drive Shaft		36		59.5	40	523
	2014.05-2017.03	6MT	F	R	Estate FWD CPVB		2613070L	Drive Shaft		36		59.5	40	820
	2014.05-2017.03	7AT	F	L	Estate FWD CPVB		2032940L	Drive Shaft		36		59.5	40	517
	2014.05-2017.03	AT	F	R	Estate FWD CPVB		2610960L	Drive Shaft		36		59.5	40	800
1.4 (103 kw)	2007.05-2008.06	AT	F	L	Estate FWD BMY		2033800L	Drive Shaft		36		59.5	40	487
	2007.05-2008.06	MT	F	L	Estate FWD BMY		2612010L	Drive Shaft		36		59.5	40	536
	2007.05-2008.06	MT	F	R	Estate FWD BMY		2610960L	Drive Shaft		36		59.5	40	800
	2013.05-2017.03	6MT	F	L	Estate FWD CHPA		2612820L	Drive Shaft		36		59.5	40	523
	2013.05-2017.03	6MT	F	R	Estate FWD CHPA		2612830L	Drive Shaft		36		59.5	40	815
	2013.05-2017.03	7DCT	F	L	Estate FWD CHPA		2611000L	Drive Shaft		36		59.5	40.5	514
	2013.05-2017.03	7DCT	F	R	Estate FWD CHPA		2033130L	Drive Shaft		36		59.5	40.5	794
	2013.05-2017.03	MT	F	L	Estate FWD CHPA		2032940L	Drive Shaft		36		59.5	40	517
1.4 (110 kw)	2014.05-	6MT	F	L	Estate FWD CHPB/CZDA		2612820L	Drive Shaft		36		59.5	40	523
	2014.05-	6MT	F	R	Estate FWD CHPB/CZDA		2612830L	Drive Shaft		36		59.5	40	815
	2014.05-	7DCT	F	L	Estate FWD CHPB/CZDA		2611000L	Drive Shaft		36		59.5	40.5	514
	2014.05-	7DCT	F	R	Estate FWD CHPB/CZDA		2033130L	Drive Shaft		36		59.5	40.5	794
	2014.05-	MT	F	L	Estate FWD CHPB/CZDA		2032940L	Drive Shaft		36		59.5	40	517
1.4 (118 kw)	2008.07-2009.12	7DCT	F	R	Estate FWD CAVD	Date From:2008.12,Chassis no. from:1K9295791	2016530L	Drive Shaft		36		59.5	40.5	785
	2008.07-2009.12	MT	F	L	Estate FWD CAVD		2612010L	Drive Shaft		36		59.5	40	536
	2008.07-2009.12	MT	F	R	Estate FWD CAVD		2610960L	Drive Shaft		36		59.5	40	800
	2009.07-2013.07	7AT	F	L	Estate FWD CAVD/CNWA/CTHD/CTKA		2612810L	Drive Shaft		36		59.5	40.5	525
	2009.07-2013.07	AT	F	R	Estate FWD CAVD/CNWA/CTHD/CTKA		2016530L	Drive Shaft		36		59.5	40.5	785
	2009.07-2013.07	MT	F	L	Estate FWD CAVD/CNWA/CTHD/CTKA	For Engine Code:CTHD	2612010L	Drive Shaft		36		59.5	40	536
	2009.07-2013.07	MT	F	R	Estate FWD CAVD/CNWA/CTHD/CTKA	For Engine Code:CAVD/CTHD	2610960L	Drive Shaft		36		59.5	40	800
1.4 (125 kw)	2007.05-2008.06	6MT	F	R	Estate FWD BLG		2016530L	Drive Shaft		36		59.5	40.5	785
	2007.05-2008.06	AT	F	L	Estate FWD BLG		2033800L	Drive Shaft		36		59.5	40	487
1.5 (96 kw)	2017.05-	7DCT	F	L	Estate FWD DACA/DPBA		2612820L	Drive Shaft		36		59.5	40	523
	2018.11-	7AT	F	L	Estate FWD DHFA		2612820L	Drive Shaft		36		59.5	40	523
	2020.12-	7DCT	F	L	Estate FWD DPBA		2612820L	Drive Shaft		36		59.5	40	523
1.5 (110 kw)	2017.03-	6MT	F	L	Estate FWD DADA/DPCA		2612820L	Drive Shaft		36		59.5	40	523
	2017.03-	7DCT	F	L	Estate FWD DADA/DPCA		2611000L	Drive Shaft		36		59.5	40.5	514
	2020.12-	7AT	F	L	Estate FWD DFYA		2611000L	Drive Shaft		36		59.5	40.5	514
1.6 (66 kw)	2009.12-2013.07	5MT	F	L	Estate FWD CAYB		2032940L	Drive Shaft		36		59.5	40	517
	2009.12-2013.07	5MT	F	R	Estate FWD CAYB		2610420L	Drive Shaft		36		59.5	40	814
	2013.05-	5MT	F	L	Estate FWD CLHB/CRKA/CXXA/DDYB	for Model cod BA5	2032940L	Drive Shaft		36		59.5	40	517
	2013.05-	5MT	F	L	Estate FWD CLHB/CRKA/CXXA/DDYB	for Model cod BV5	2612820L	Drive Shaft		36		59.5	40	523
	2013.05-	5MT	F	R	Estate FWD CLHB/CRKA/CXXA/DDYB	for Model cod BA5	2610420L	Drive Shaft		36		59.5	40	814
	2013.05-	5MT	F	R	Estate FWD CLHB/CRKA/CXXA/DDYB	for Model cod BV5	2612830L	Drive Shaft		36		59.5	40	815
1.6 (75 kw)	2007.06-2009.07	6AT	F	R	Estate FWD BSE/BSF/CCSA		2610940L	Drive Shaft		36	26	59.5	40	884
	2007.06-2009.07	MT	F	R	Estate FWD BSE/BSF/CCSA		2610960L	Drive Shaft		36		59.5	40	800
	2008.01-2009.12	5MT	F	R	Estate FWD CCSA		2610960L	Drive Shaft		36		59.5	40	800
	2009.07-2010.12	5MT	F	R	Estate FWD BSF		2610960L	Drive Shaft		36		59.5	40	800
	2009.07-2013.07	5MT	F	R	Estate FWD BSE/BSF/CCSA		2610960L	Drive Shaft		36		59.5	40	800



 YEAR	TRANSM.	F/R	L/R	BODY STYLE & DRIVE TYPE & ENGINE	REMARKS	GSP Ref.	 PRODUCT	 ABS	Technical Specifications				
									A	B	C	H	L
VW													
Golf Estate/Variant													
1.6 (75 kw)	2010.07-2013.07	5MT	F	R	Estate FWD CCSA/CMXA		2610960L	Drive Shaft	36	59.5	40	800	
1.6 (77 kw)	2009.07-2013.07	6MT	F	L	Estate 4WD CAYC		2032950L	Drive Shaft	36	59.5	40.5	486	
	2009.07-2013.07	6MT	F	R	Estate 4WD CAYC		2032660L	Drive Shaft	36	59.5	40.5	601	
	2009.07-2013.07	MT	F	L	Estate 4WD CAYC		2032940L	Drive Shaft	36	59.5	40	517	
	2009.07-2013.07	MT	F	R	Estate 4WD CAYC		2610420L	Drive Shaft	36	59.5	40	814	
	2009.07-2013.07		F	L	Estate 4WD CAYC		2033800L	Drive Shaft	36	59.5	40	487	
	2009.07-2013.07	AT	F	R	Estate FWD CAYC		2033130L	Drive Shaft	36	59.5	40.5	794	
	2009.07-2013.07	AT	F	R	Estate FWD CAYC	For Modelcode:BA5	2610420L	Drive Shaft	36	59.5	40	814	
	2009.07-2013.07	MT	F	L	Estate FWD CAYC		2032940L	Drive Shaft	36	59.5	40	517	
	2009.07-2013.07	Semi-AT	F	L	Estate FWD CAYC	Date To:2011.06	2033800L	Drive Shaft	36	59.5	40	487	
	2009.07-2013.07	Semi-AT	F	R	Estate FWD CAYC	Date From:2011.06	2610960L	Drive Shaft	36	59.5	40	800	
	2013.05-2017.03	5MT	F	R	Estate FWD CLHA		2612830L	Drive Shaft	36	59.5	40	815	
	2013.05-2017.03	7AT/5MT	F	L	Estate FWD CLHA		2612820L	Drive Shaft	36	59.5	40	523	
	2013.05-2017.03	7DCT	F	R	Estate FWD CLHA		2610960L	Drive Shaft	36	59.5	40	800	
	2013.05-2017.03	AT/MT	F	L	Estate FWD CLHA		2032940L	Drive Shaft	36	59.5	40	517	
	2013.05-2017.03		F	R	Estate FWD CLHA	For Modelcode:BV5	2610420L	Drive Shaft	36	59.5	40	814	
1.6 (81 kw)	2013.05-2017.03	5MT/6MT	F	R	Estate FWD CRKB/CXXB/DBKA		2612830L	Drive Shaft	36	59.5	40	815	
	2013.05-2017.03	5MT/6MT/7DCT	F	L	Estate FWD CRKB/CXXB/DBKA		2612820L	Drive Shaft	36	59.5	40	523	
	2013.05-2017.03	7DCT	F	R	Estate FWD CRKB/CXXB/DBKA		2610960L	Drive Shaft	36	59.5	40	800	
	2013.05-2017.03	AT/MT	F	L	Estate FWD CRKB/CXXB/DBKA		2032940L	Drive Shaft	36	59.5	40	517	
	2013.05-2017.03		F	R	Estate FWD CRKB/CXXB/DBKA	For Modelcode:BV5	2610420L	Drive Shaft	36	59.5	40	814	
	2014.05-2017.03	5MT	F	R	Estate FWD CWVA		2610960L	Drive Shaft	36	59.5	40	800	
	2014.05-2017.03	AT	F	L	Estate FWD CWVA	Date To:2017.03/For PRR code:1PE/1PF/1PA/2H4	2032940L	Drive Shaft	36	59.5	40	517	
	2014.05-2017.03	AT	F	R	Estate FWD CWVA	Date To:2017.03	2610420L	Drive Shaft	36	59.5	40	814	
	2014.05-2017.03	MT	F	L	Estate FWD CWVA		2033730L	Drive Shaft	36	59.5	40	517	
	1.6 (85 kw)	2016.11-	5MT	F	R	Estate FWD DDYA/DGTE		2612830L	Drive Shaft	36	59.5	40	815
2016.11-		7AT/5MT	F	L	Estate FWD DDYA/DGTE		2612820L	Drive Shaft	36	59.5	40	523	
2016.11-		7DCT	F	R	Estate FWD DDYA/DGTE		2610960L	Drive Shaft	36	59.5	40	800	
2016.11-			F	R	Estate FWD DDYA/DGTE	For Modelcode:BV5	2610420L	Drive Shaft	36	59.5	40	814	
2016.11-			F	L	Estate FWD DDYA/DGTE		2032940L	Drive Shaft	36	59.5	40	517	
1.9 (77 kw)	2007.05-2009.06	6AT	F	L	Estate FWD BLS/BXE		2540130L	Drive Shaft	36	59.5	40.5	482	
	2007.05-2009.06	6AT	F	R	Estate FWD BLS/BXE		2540110L	Drive Shaft	36	59.5	40.5	760	
	2007.05-2009.06	7DCT	F	L	Estate FWD BLS/BXE	Date From:2008.11	2611000L	Drive Shaft	36	59.5	40.5	514	
	2007.05-2009.06	7DCT	F	R	Estate FWD BLS/BXE	Date From:2008.12/Chassis no. from:1K925791	2033130L	Drive Shaft	36	59.5	40.5	794	
	2007.05-2009.06	MT	F	L	Estate FWD BLS/BXE		2032940L	Drive Shaft	36	59.5	40	517	
	2007.05-2009.06	MT	F	R	Estate FWD BLS/BXE		2610420L	Drive Shaft	36	59.5	40	814	
	2007.12-2009.07	MT	F	L	Estate 4WD BLS		2032950L	Drive Shaft	36	59.5	40.5	486	
	2007.12-2009.07	MT	F	L	Estate 4WD BLS		2033800L	Drive Shaft	36	59.5	40	487	
	2007.12-2009.07	MT	F	R	Estate 4WD BLS		2032660L	Drive Shaft	36	59.5	40.5	601	
	2.0 (81 kw)	2010.01-2013.07	5MT	F	L	Estate FWD CLCA		2032940L	Drive Shaft	36	59.5	40	517
2010.01-2013.07		5MT	F	R	Estate FWD CLCA		2610420L	Drive Shaft	36	59.5	40	814	
2013.05-		6DCT	F	L	Estate FWD CRLD/CRVA/CYKB/DCYB/DE/BJ/DFGB		2612850L	Drive Shaft	36	59.5	40	472	
2013.05-		6DCT	F	R	Estate FWD CRLD/CRVA/CYKB/DCYB/DE/BJ/DFGB		2033540L	Drive Shaft	36	59.5	40	760	
2013.05-		6MT	F	L	Estate FWD CRLD/CRVA/CYKB/DCYB/DE/BJ/DFGB	For taxis	2032950L	Drive Shaft	36	59.5	40.5	486	
2013.05-		6MT	F	R	Estate FWD CRLD/CRVA/CYKB/DCYB/DE/BJ/DFGB		2033130L	Drive Shaft	36	59.5	40.5	794	
2013.05-		7AT	F	R	Estate FWD CRLD/CRVA/CYKB/DCYB/DE/BJ/DFGB		2610960L	Drive Shaft	36	59.5	40	800	
2013.05-		7DCT	F	L	Estate FWD CRLD/CRVA/CYKB/DCYB/DE/BJ/DFGB		2012650L	Drive Shaft	36	37	59.5	40	558
2013.05-		MT/7AT	F	L	Estate FWD CRLD/CRVA/CYKB/DCYB/DE/BJ/DFGB	Inner teeth of wheel side:30	2032940L	Drive Shaft	36	59.5	40	517	
2.0 (100 kw)		2007.05-2009.07	6MT	F	L	Estate FWD AZV/CBDA		2032950L	Drive Shaft	36	59.5	40.5	486
	2007.05-2009.07	6MT	F	R	Estate FWD AZV/CBDA		2033130L	Drive Shaft	36	59.5	40.5	794	
	2007.05-2009.07	AT	F	R	Estate FWD AZV/CBDA		2540110L	Drive Shaft	36	59.5	40.5	760	
	2007.05-2009.07	MT	F	L	Estate FWD AZV/CBDA		2033800L	Drive Shaft	36	59.5	40	487	
	2009.07-2013.07	6MT	F	L	Estate FWD CBDA/CFHB		2032950L	Drive Shaft	36	59.5	40.5	486	
	2009.07-2013.07	MT	F	R	Estate FWD CBDA/CFHB		2033130L	Drive Shaft	36	59.5	40.5	794	
	2009.07-2013.07	6DCT	F	L	Estate FWD BKD/CBDB		2540130L	Drive Shaft	36	59.5	40.5	482	
2.0 (103 kw)	2007.05-2009.07	6DCT	F	R	Estate FWD BKD/CBDB		2540110L	Drive Shaft	36	59.5	40.5	760	
	2007.05-2009.07	6MT	F	L	Estate FWD BKD/CBDB		2032950L	Drive Shaft	36	59.5	40.5	486	
	2007.05-2009.07	6MT	F	R	Estate FWD BKD/CBDB		2033130L	Drive Shaft	36	59.5	40.5	794	
	2007.05-2009.07	MT	F	L	Estate FWD BKD/CBDB		2033800L	Drive Shaft	36	59.5	40	487	
	2007.05-2009.07	6DCT	F	L	Estate FWD BMM		2540130L	Drive Shaft	36	59.5	40.5	482	
	2007.05-2009.07	6DCT	F	R	Estate FWD BMM		2540110L	Drive Shaft	36	59.5	40.5	760	
	2007.05-2009.07	6MT	F	L	Estate FWD BMM		2032950L	Drive Shaft	36	59.5	40.5	486	
	2007.05-2009.07	6MT	F	R	Estate FWD BMM		2033130L	Drive Shaft	36	59.5	40.5	794	
	2009.07-2013.07	AT	F	L	Estate FWD CBDB/CFHC/CJAA		2540130L	Drive Shaft	36	59.5	40.5	482	
	2009.07-2013.07	AT	F	R	Estate FWD CBDB/CFHC/CJAA		2540110L	Drive Shaft	36	59.5	40.5	760	
	2009.07-2013.07	MT	F	L	Estate FWD CBDB/CFHC/CJAA		2032950L	Drive Shaft	36	59.5	40.5	486	



 YEAR	TRANSM.	F/R	L/R	BODY STYLE & DRIVE TYPE & ENGINE	REMARKS	GSP Ref.	 PRODUCT	 ABS	Technical Specifications					
									A	B	C	H	L	
VW														
Golf Estate/Variant														
2.0 (103 kw)	2009.07-2013.07	MT	F	L	Estate FWD CBDB/CFHC/CJAA		2033800L	Drive Shaft		36		59.5	40	487
	2009.07-2013.07	MT	F	R	Estate FWD CBDB/CFHC/CJAA		2033130L	Drive Shaft		36		59.5	40.5	794
2.0 (110 kw)	2013.04-	6DCT	F	L	Estate FWD CRBC/CRLB/DCYA/DEJA/DFGA		2612850L	Drive Shaft		36		59.5	40	472
	2013.04-	6DCT	F	R	Estate FWD CRBC/CRLB/DCYA/DEJA/DFGA		2033540L	Drive Shaft		36		59.5	40	760
	2013.04-	6MT	F	L	Estate FWD CRBC/CRLB/DCYA/DEJA/DFGA	For PR code:F4E/F4F/F5Z/F6U,For taxis	2032950L	Drive Shaft		36		59.5	40.5	486
	2013.04-	6MT	F	R	Estate FWD CRBC/CRLB/DCYA/DEJA/DFGA		2033130L	Drive Shaft		36		59.5	40.5	794
	2013.04-	7DCT	F	L	Estate FWD CRBC/CRLB/DCYA/DEJA/DFGA		2012650L	Drive Shaft		36	37	59.5	40	558
2.0 (135 kw)	2015.01-	6DCT	F	L	Estate FWD CUNA/DGCA/DJGA		2612850L	Drive Shaft		36		59.5	40	472
	2015.01-	6DCT	F	R	Estate FWD CUNA/DGCA/DJGA		2033540L	Drive Shaft		36		59.5	40	760
	2015.01-	6MT	F	L	Estate FWD CUNA/DGCA/DJGA	For PR code:1PE/1PF/1PA/2H4	2032950L	Drive Shaft		36		59.5	40.5	486
	2015.01-	7DCT	F	L	Estate FWD CUNA/DGCA/DJGA		2012650L	Drive Shaft		36	37	59.5	40	558
2.0 (147 kw)	2007.05-2009.06	6DCT	F	L	Estate FWD BWA/CAWB	For Engine Code:CAWB	2032950L	Drive Shaft		36		59.5	40.5	486
	2007.05-2009.06	6DCT	F	R	Estate FWD BWA/CAWB	For Engine Code:CAWB	2032660L	Drive Shaft		36		59.5	40.5	601
	2007.05-2009.06	AT	F	L	Estate FWD BWA/CAWB		2032950L	Drive Shaft		36		59.5	40.5	486
	2007.05-2009.06	AT/MT	F	L	Estate FWD BWA/CAWB		2033800L	Drive Shaft		36		59.5	40	487
	2009.07-2013.07	AT	F	L	Estate FWD CCZA		2032950L	Drive Shaft		36		59.5	40.5	486
Golf Plus														
1.2 (63 kw)	2010.05-2014.08	MT	F	L	Hatchback FWD CBZA		2612010L	Drive Shaft		36		59.5	40	536
	2010.05-2014.08	MT	F	R	Hatchback FWD CBZA		2610960L	Drive Shaft		36		59.5	40	800
1.2 (77 kw)	2009.11-2014.08	AT/MT	F	L	Hatchback FWD CBZB		2612010L	Drive Shaft		36		59.5	40	536
	2009.11-2014.08	AT/MT	F	R	Hatchback FWD CBZB		2610960L	Drive Shaft		36		59.5	40	800
	2009.11-2014.08	AT/MT	F	L	Hatchback Van FWD CBZB		2612010L	Drive Shaft		36		59.5	40	536
	2009.11-2014.08	AT/MT	F	R	Hatchback Van FWD CBZB		2610960L	Drive Shaft		36		59.5	40	800
1.4 (90 kw)	2007.07-2014.08	6MT	F	L	Hatchback FWD CAXA	Date to:2008.04,Date from:2008.05	2612010L	Drive Shaft		36		59.5	40	536
	2007.07-2014.08	6MT	F	R	Hatchback FWD CAXA		2610960L	Drive Shaft		36		59.5	40	800
	2007.07-2014.08	7DCT	F	L	Hatchback FWD CAXA	Date from:2008.11,Date to:2011.05	2612810L	Drive Shaft		36		59.5	40.5	525
	2007.07-2014.08	7DCT	F	R	Hatchback FWD CAXA	Date from:2008.11,Date to:2011.05	2016530L	Drive Shaft		36		59.5	40.5	785
	2009.01-2014.08	AT	F	L	Hatchback Van FWD CAXA		2612810L	Drive Shaft		36		59.5	40.5	525
	2009.01-2014.08	AT	F	R	Hatchback Van FWD CAXA		2016530L	Drive Shaft		36		59.5	40.5	785
	2009.01-2014.08	MT	F	L	Hatchback Van FWD CAXA		2612010L	Drive Shaft		36		59.5	40	536
1.4 (103 kw)	2006.05-2008.06	6MT	F	L	Hatchback FWD BMY	Chassis no. to:1K7650000;Chassis no. from:1K8500001	2612010L	Drive Shaft		36		59.5	40	536
	2006.05-2008.06	6MT	F	R	Hatchback FWD BMY	Chassis no. to:1K7650000;Chassis no. from:1K8500001	2610960L	Drive Shaft		36		59.5	40	800
	2006.05-2008.06	AT	F	L	Hatchback FWD BMY		2033800L	Drive Shaft		36		59.5	40	487
1.4 (118 kw)	2008.05-2014.08	AT	F	L	Hatchback FWD CAVD/CNWA/CTHD	Date From:2008.11	2612810L	Drive Shaft		36		59.5	40.5	525
	2008.05-2014.08	AT	F	R	Hatchback FWD CAVD/CNWA/CTHD	Date From:2008.11	2016530L	Drive Shaft		36		59.5	40.5	785
	2008.05-2014.08	MT	F	L	Hatchback FWD CAVD/CNWA/CTHD		2612010L	Drive Shaft		36		59.5	40	536
	2008.05-2014.08	MT	F	R	Hatchback FWD CAVD/CNWA/CTHD		2610960L	Drive Shaft		36		59.5	40	800
	2009.01-2012.09	AT	F	L	Hatchback Van FWD CAVD		2612810L	Drive Shaft		36		59.5	40.5	525
	2009.01-2012.09	AT	F	R	Hatchback Van FWD CAVD		2016530L	Drive Shaft		36		59.5	40.5	785
	2009.01-2012.09	MT	F	L	Hatchback Van FWD CAVD		2612010L	Drive Shaft		36		59.5	40	536
	2009.01-2012.09	MT	F	R	Hatchback Van FWD CAVD		2610960L	Drive Shaft		36		59.5	40	800
1.4 (125 kw)	2006.05-2008.06	AT	F	L	Hatchback FWD BLG		2033800L	Drive Shaft		36		59.5	40	487
	2006.05-2008.06	MT	F	R	Hatchback FWD BLG		2016530L	Drive Shaft		36		59.5	40.5	785
1.6 (66 kw)	2009.02-2014.08	5MT	F	L	Hatchback FWD CAYB		2032940L	Drive Shaft		36		59.5	40	517
	2009.02-2014.08	5MT	F	R	Hatchback FWD CAYB		2610420L	Drive Shaft		36		59.5	40	814
	2009.02-2014.08	5MT	F	L	Hatchback Van FWD CAYB		2032940L	Drive Shaft		36		59.5	40	517
	2009.02-2014.08	5MT	F	R	Hatchback Van FWD CAYB		2610420L	Drive Shaft		36		59.5	40	814
1.6 (75 kw)	2005.05-2014.08	7DCT	F	L	Hatchback FWD BSE/BSF/CCSA/CMXA		2032940L	Drive Shaft		36		59.5	40	517
	2005.05-2014.08	7DCT	F	R	Hatchback FWD BSE/BSF/CCSA/CMXA		2610420L	Drive Shaft		36		59.5	40	814
	2005.05-2014.08	MT	F	R	Hatchback FWD BSE/BSF/CCSA/CMXA		2610960L	Drive Shaft		36		59.5	40	800
	2007.11-2014.08	AT	F	R	Hatchback FWD CCSA/CMXA		2610940L	Drive Shaft		36	26	59.5	40	884
	2007.11-2014.08	MT	F	R	Hatchback FWD CCSA/CMXA		2610960L	Drive Shaft		36		59.5	40	800
	2009.05-2014.08	5MT	F	R	Hatchback FWD CHGA		2610960L	Drive Shaft		36		59.5	40	800
	2009.02-2014.08	5MT	F	L	Hatchback FWD CAYC		2032940L	Drive Shaft		36		59.5	40	517
1.6 (77 kw)	2009.02-2014.08	5MT	F	R	Hatchback FWD CAYC		2610420L	Drive Shaft		36		59.5	40	814
	2009.02-2014.08	7DCT	F	L	Hatchback FWD CAYC	Date to:2011.05	2611000L	Drive Shaft		36		59.5	40.5	514
	2009.02-2014.08	7DCT	F	L	Hatchback FWD CAYC	Date From:2011.06	2612820L	Drive Shaft		36		59.5	40	523
	2009.02-2014.08	7DCT	F	R	Hatchback FWD CAYC	Date to:2011.05	2033130L	Drive Shaft		36		59.5	40.5	794
	2009.02-2014.08	7DCT	F	R	Hatchback FWD CAYC	Date From:2011.06	2610960L	Drive Shaft		36		59.5	40	800
	2009.02-2014.08	7DCT	F	L	Hatchback Van FWD CAYC	Date From:2011.06	2612820L	Drive Shaft		36		59.5	40	523
	2009.02-2014.08	7DCT	F	R	Hatchback Van FWD CAYC	Date From:2011.06	2610960L	Drive Shaft		36		59.5	40	800
	2009.02-2014.08	AT	F	L	Hatchback Van FWD CAYC		2611000L	Drive Shaft		36		59.5	40.5	514
	2009.02-2014.08	MT	F	L	Hatchback Van FWD CAYC		2032940L	Drive Shaft		36		59.5	40	517
	2009.02-2014.08	MT	F	R	Hatchback Van FWD CAYC		2610420L	Drive Shaft		36		59.5	40	814

	YEAR	TRANSM.	F/R	L/R	BODY STYLE & DRIVE TYPE & ENGINE	REMARKS	GSP Ref.	PRODUCT	ABS	Technical Specifications					
										A	B	C	H	L	
VW Golf Plus															
1.6 (77 kw)	2009.02-2014.08		F	R	Hatchback Van FWD CAYC		2033130L	Drive Shaft		36		59.5	40.5	794	
1.6 (85 kw)	2004.12-2008.05	AT	F	R	Hatchback FWD BLF	Date From:2005.01	2610940L	Drive Shaft		36	26	59.5	40	884	
	2004.12-2008.05	MT	F	R	Hatchback FWD BLF		2612110L	Drive Shaft		36		59.5	40.5	784	
1.9 (66 kw)	2005.05-2008.12	5MT	F	L	Hatchback FWD BRU/BXF/BXJ		2032940L	Drive Shaft		36		59.5	40	517	
	2005.05-2008.12	5MT	F	R	Hatchback FWD BRU/BXF/BXJ		2610420L	Drive Shaft		36		59.5	40	814	
1.9 (77 kw)	2005.01-2009.01	5MT	F	R	Hatchback FWD BKC/BLS/BXE		2610420L	Drive Shaft		36		59.5	40	814	
	2005.01-2009.01	5MT/6MT	F	L	Hatchback FWD BKC/BLS/BXE		2032940L	Drive Shaft		36		59.5	40	517	
	2005.01-2009.01	6DCT	F	L	Hatchback FWD BKC/BLS/BXE		2033810L	Drive Shaft		36		59.5	40	485	
	2005.01-2009.01	6DCT	F	L	Hatchback FWD BKC/BLS/BXE		2540130L	Drive Shaft		36		59.5	40.5	482	
	2005.01-2009.01	6DCT	F	R	Hatchback FWD BKC/BLS/BXE		2033540L	Drive Shaft		36		59.5	40	760	
	2005.01-2009.01	6DCT	F	R	Hatchback FWD BKC/BLS/BXE		2540110L	Drive Shaft		36		59.5	40.5	760	
	2005.01-2009.01	7AT	F	L	Hatchback FWD BKC/BLS/BXE	Date From:2008.11	2611000L	Drive Shaft		36		59.5	40.5	514	
2.0 (81 kw)	2005.01-2009.01	7DCT	F	R	Hatchback FWD BKC/BLS/BXE	Date from:2008.11	2033130L	Drive Shaft		36		59.5	40.5	794	
	2009.01-2014.08	5MT	F	L	Hatchback FWD CBDC/CLCA		2032940L	Drive Shaft		36		59.5	40	517	
	2009.01-2014.08	5MT	F	R	Hatchback FWD CBDC/CLCA		2610420L	Drive Shaft		36		59.5	40	814	
	2009.01-2014.08	6DCT	F	L	Hatchback FWD CBDC/CLCA		2540130L	Drive Shaft		36		59.5	40.5	482	
2.0 (96 kw)	2009.01-2014.08	6DCT	F	R	Hatchback FWD CBDC/CLCA		2540110L	Drive Shaft		36		59.5	40.5	760	
	2005.05-2007.05	6MT	F	L	Hatchback FWD BEE		2032950L	Drive Shaft		36		59.5	40.5	486	
	2005.05-2007.05	6MT	F	R	Hatchback FWD BEE		2033130L	Drive Shaft		36		59.5	40.5	794	
	2005.05-2007.05	6MT	F	R	Hatchback FWD BEE	Date From:2007.03/For Modelcode:5M1/For PR code:ABT	2611470L	Drive Shaft		36		59.5	40.5	795	
2.0 (100 kw)	2005.01-2014.08	6MT	F	L	Hatchback FWD AZV/CBDA/CFHB		2032950L	Drive Shaft		36		59.5	40.5	486	
	2005.01-2014.08	6MT	F	L	Hatchback FWD AZV/CBDA/CFHB		2033800L	Drive Shaft		36		59.5	40	487	
	2005.01-2014.08	6MT	F	R	Hatchback FWD AZV/CBDA/CFHB		2033130L	Drive Shaft		36		59.5	40.5	794	
	2005.01-2014.08	6MT	F	R	Hatchback FWD AZV/CBDA/CFHB	Date From:2007.03/For Modelcode:5M1/For PR code:ABT	2611470L	Drive Shaft		36		59.5	40.5	795	
	2005.01-2014.08	AT	F	L	Hatchback FWD AZV/CBDA/CFHB		2540130L	Drive Shaft		36		59.5	40.5	482	
	2005.01-2014.08	AT	F	R	Hatchback FWD AZV/CBDA/CFHB		2540110L	Drive Shaft		36		59.5	40.5	760	
	2005.01-2014.08	MT	F	R	Hatchback FWD AZV/CBDA/CFHB		2033800L	Drive Shaft		36		59.5	40	487	
2.0 (103 kw)	2005.01-2014.08	6DCT	F	L	Hatchback FWD BKD/CBDB/CFHC	For Modelcode:521/For PR code:ABT/Check no. from:19C590001	2033810L	Drive Shaft		36		59.5	40	485	
	2005.01-2014.08	6DCT	F	L	Hatchback FWD BKD/CBDB/CFHC		2540130L	Drive Shaft		36		59.5	40.5	482	
	2005.01-2014.08	6DCT	F	R	Hatchback FWD BKD/CBDB/CFHC		2540110L	Drive Shaft		36		59.5	40.5	760	
	2005.01-2014.08	6MT	F	L	Hatchback FWD BKD/CBDB/CFHC		2032950L	Drive Shaft		36		59.5	40.5	486	
	2005.01-2014.08	6MT	F	L	Hatchback FWD BKD/CBDB/CFHC		2033800L	Drive Shaft		36		59.5	40	487	
	2005.01-2014.08	6MT	F	R	Hatchback FWD BKD/CBDB/CFHC		2033130L	Drive Shaft		36		59.5	40.5	794	
	2005.01-2014.08	6MT	F	R	Hatchback FWD BKD/CBDB/CFHC	Date From:2007.03/For Modelcode:5M1/For PR code:ABT	2611470L	Drive Shaft		36		59.5	40.5	795	
	2005.01-2014.08	MT	F	L	Hatchback FWD BKD/CBDB/CFHC		2033800L	Drive Shaft		36		59.5	40	487	
	2005.12-2008.12	6MT	F	L	Hatchback FWD BMM		2032950L	Drive Shaft		36		59.5	40.5	486	
	2005.12-2008.12	6MT	F	R	Hatchback FWD BMM		2033130L	Drive Shaft		36		59.5	40.5	794	
	2005.12-2008.12	6MT	F	R	Hatchback FWD BMM	Date From:2007.03/For Modelcode:5M1/For PR code:ABT	2611470L	Drive Shaft		36		59.5	40.5	795	
	2005.12-2008.12	AT	F	L	Hatchback FWD BMM		2540130L	Drive Shaft		36		59.5	40.5	482	
	2005.12-2008.12	AT	F	R	Hatchback FWD BMM		2540110L	Drive Shaft		36		59.5	40.5	760	
	2009.11-2014.08	6DCT	F	L	Hatchback Van FWD CFHC	For Modelcode:521/For PR code:ABT/Check no. from:19C590001	2033810L	Drive Shaft		36		59.5	40	485	
	2009.11-2014.08	6DCT	F	L	Hatchback Van FWD CFHC		2540130L	Drive Shaft		36		59.5	40.5	482	
	2009.11-2014.08	6DCT	F	R	Hatchback Van FWD CFHC		2540110L	Drive Shaft		36		59.5	40.5	760	
	2009.11-2014.08	6MT	F	L	Hatchback Van FWD CFHC		2032950L	Drive Shaft		36		59.5	40.5	486	
	2009.11-2014.08	6MT	F	R	Hatchback Van FWD CFHC	Check no. 191988000/For PR code:ABT/Check no. from:19C590001	2033130L	Drive Shaft		36		59.5	40.5	794	
	2.0 (110 kw)	2004.12-2008.06	AT	F	R	Hatchback FWD BLR/BLY/BVY/BVZ		2610940L	Drive Shaft		36	26	59.5	40	884
		2004.12-2008.06	MT	F	L	Hatchback FWD BLR/BLY/BVY/BVZ		2032940L	Drive Shaft		36		59.5	40	517
2004.12-2008.06		MT	F	R	Hatchback FWD BLR/BLY/BVY/BVZ		2610420L	Drive Shaft		36		59.5	40	814	
Golf Sportsvan															
1.2 (63 kw)	2014.05-	5MT	F	R	Hatchback FWD CYVA		2610960L	Drive Shaft		36		59.5	40	800	
1.2 (81 kw)	2014.04-	6MT	F	L	Hatchback FWD CYVB		2033730L	Drive Shaft		36		59.5	40	517	
	2014.04-	6MT	F	R	Hatchback FWD CYVB		2613070L	Drive Shaft		36		59.5	40	820	
	2014.04-	7DCT	F	L	Hatchback FWD CYVB		2612820L	Drive Shaft		36		59.5	40	523	
	2014.04-	7DCT	F	R	Hatchback FWD CYVB		2610960L	Drive Shaft		36		59.5	40	800	
	2014.04-	7DCT	F	R	Hatchback FWD CYVB		2612820L	Drive Shaft		36		59.5	40.5	760	
1.4 (92 kw)	2014.04-	6MT	F	L	Hatchback FWD CPVB		2612820L	Drive Shaft		36		59.5	40	523	
	2014.04-	6MT	F	R	Hatchback FWD CPVB		2613070L	Drive Shaft		36		59.5	40	820	
	2014.04-	7AT	F	L	Hatchback FWD CPVB		2032940L	Drive Shaft		36		59.5	40	517	
	2014.04-	6MT	F	R	Hatchback FWD CZCA		2613070L	Drive Shaft		36		59.5	40	820	
	2014.04-	6MT/7DCT	F	L	Hatchback FWD CZCA		2612820L	Drive Shaft		36		59.5	40	523	
	2014.04-	7DCT	F	R	Hatchback FWD CZCA		2610960L	Drive Shaft		36		59.5	40	800	
1.4 (110 kw)	2014.02-	6MT	F	L	Hatchback FWD CZDA		2612820L	Drive Shaft		36		59.5	40	523	
	2014.02-	6MT	F	R	Hatchback FWD CZDA		2612830L	Drive Shaft		36		59.5	40	815	
	2014.02-	7DCT	F	L	Hatchback FWD CZDA		2611000L	Drive Shaft		36		59.5	40.5	514	
	2014.02-	7DCT	F	R	Hatchback FWD CZDA		2033130L	Drive Shaft		36		59.5	40.5	794	
1.5 (96 kw)	2017.05-	7DCT	F	L	Hatchback FWD DACA/DPBA		2612820L	Drive Shaft		36		59.5	40	523	



 YEAR	TRANSM.	F/R	L/R	BODY STYLE & DRIVE TYPE & ENGINE	REMARKS	GSP Ref.	 PRODUCT	 ABS	Technical Specifications				
									A	B	C	H	L
VW													
Golf Sportsvan													
1.5 (110 kw)	2017.05-	7AT	F	L	Hatchback FWD DADA/DPCA		2611000L	Drive Shaft	36	59.5	40.5	514	
1.6 (66 kw)	2014.02-	5MT	F	L	Hatchback FWD CRKA/CXXA/DDYB	Date To:2016.10	2032940L	Drive Shaft	36	59.5	40	517	
	2014.02-	5MT	F	L	Hatchback FWD CRKA/CXXA/DDYB	Date From:2016.11	2612820L	Drive Shaft	36	59.5	40	523	
	2014.02-	5MT	F	R	Hatchback FWD CRKA/CXXA/DDYB	Date To:2016.10	2610420L	Drive Shaft	36	59.5	40	814	
	2014.02-	5MT	F	R	Hatchback FWD CRKA/CXXA/DDYB	Date From:2016.11	2612830L	Drive Shaft	36	59.5	40	815	
1.6 (81 kw)	2014.02-	5MT/6MT	F	R	Hatchback FWD CRKB/CXXB/DBKA	Date From:2016.11	2610420L	Drive Shaft	36	59.5	40	814	
	2014.02-	5MT/6MT	F	R	Hatchback FWD CRKB/CXXB/DBKA		2612830L	Drive Shaft	36	59.5	40	815	
	2014.02-	5MT/6MT/7DCT	F	L	Hatchback FWD CRKB/CXXB/DBKA		2612820L	Drive Shaft	36	59.5	40	523	
	2014.02-	7DCT	F	R	Hatchback FWD CRKB/CXXB/DBKA		2610960L	Drive Shaft	36	59.5	40	800	
	2014.02-	AT	F	L	Hatchback FWD CRKB/CXXB/DBKA		2032940L	Drive Shaft	36	59.5	40	517	
	2014.05-	5MT	F	R	Hatchback FWD CWVA		2610960L	Drive Shaft	36	59.5	40	800	
	2014.05-	MT	F	L	Hatchback FWD CWVA		2033730L	Drive Shaft	36	59.5	40	517	
	2014.05-	MT	F	L	Hatchback FWD CWVA		2033730L	Drive Shaft	36	59.5	40	517	
1.6 (85 kw)	2016.11-	5MT	F	R	Hatchback FWD DDYA/DGTE		2612830L	Drive Shaft	36	59.5	40	815	
	2016.11-	5MT/7DCT	F	L	Hatchback FWD DDYA/DGTE		2612820L	Drive Shaft	36	59.5	40	523	
	2016.11-	7DCT	F	R	Hatchback FWD DDYA/DGTE		2610960L	Drive Shaft	36	59.5	40	800	
	2016.11-		F	R	Hatchback FWD DDYA/DGTE	Date From:2016.11	2610420L	Drive Shaft	36	59.5	40	814	
2.0 (81 kw)	2014.05-2017.11	5MT	F	L	Hatchback FWD CRLD/CRVA/DCYB	Inner teeth of wheel side:33	2612820L	Drive Shaft	36	59.5	40	523	
	2014.05-2017.11	5MT	F	R	Hatchback FWD CRLD/CRVA/DCYB	Inner teeth of wheel side:30	2610420L	Drive Shaft	36	59.5	40	814	
	2014.05-2017.11	5MT	F	R	Hatchback FWD CRLD/CRVA/DCYB	Inner teeth of wheel side:33	2612830L	Drive Shaft	36	59.5	40	815	
	2014.05-2017.11	6DCT	F	L	Hatchback FWD CRLD/CRVA/DCYB		2612850L	Drive Shaft	36	59.5	40	472	
	2014.05-2017.11	6DCT	F	R	Hatchback FWD CRLD/CRVA/DCYB		2033540L	Drive Shaft	36	59.5	40	760	
	2014.05-2017.11	AT	F	R	Hatchback FWD CRLD/CRVA/DCYB		2610960L	Drive Shaft	36	59.5	40	800	
	2014.05-2017.11	AT/MT	F	L	Hatchback FWD CRLD/CRVA/DCYB	Inner teeth of wheel side:30	2032940L	Drive Shaft	36	59.5	40	517	
	2014.05-2017.11	AT/MT	F	L	Hatchback FWD CRLD/CRVA/DCYB	Inner teeth of wheel side:30	2032940L	Drive Shaft	36	59.5	40	517	
2.0 (110 kw)	2014.02-	6DCT	F	L	Hatchback FWD CRLB/DCYA/DFGA	For PR code:1PE/1PF/1PA/2H4/2H0/2H5	2612850L	Drive Shaft	36	59.5	40	472	
	2014.02-	6DCT	F	R	Hatchback FWD CRLB/DCYA/DFGA		2033540L	Drive Shaft	36	59.5	40	760	
	2014.02-	6MT	F	L	Hatchback FWD CRLB/DCYA/DFGA	For PR code:F4E/F4F/F5Z,For taxis	2032950L	Drive Shaft	36	59.5	40.5	466	
	2014.02-	6MT	F	R	Hatchback FWD CRLB/DCYA/DFGA	For PR code:19C/19E/19D/20G/20F/20E/19B/19A/19G/19F/19E/19D/19C	2033130L	Drive Shaft	36	59.5	40.5	794	
	2014.02-	6MT	F	R	Hatchback FWD CRLB/DCYA/DFGA	For PR code:1PE/1PF/2H4/1PA/2H0/2H5/F5F/F5M	2033730L	Drive Shaft	36	59.5	40	517	
	2014.02-	7DCT	F	L	Hatchback FWD CRLB/DCYA/DFGA		2012650L	Drive Shaft	36	37	59.5	40	558
Golf Van (Variant)													
1.2 (63 kw)	2013.05-2017.03	5MT	F	L	Combi Van FWD CJZB/CYVA	Code CJZB,For PR code:1PE/1PF/1PA/2H4,For PR code:19C	2033730L	Drive Shaft	36	59.5	40	517	
	2013.05-2017.03	5MT	F	R	Combi Van FWD CJZB/CYVA		2610960L	Drive Shaft	36	59.5	40	800	
	2013.05-2017.03	MT	F	L	Combi Van FWD CJZB/CYVA		2032940L	Drive Shaft	36	59.5	40	517	
	2013.05-2017.03	MT	F	R	Combi Van FWD CJZB/CYVA		2610420L	Drive Shaft	36	59.5	40	814	
	2013.05-2017.03	MT	F	R	Combi Van FWD CJZB/CYVA		2610960L	Drive Shaft	36	59.5	40	800	
1.2 (77 kw)	2009.09-2014.05	6MT	F	R	Combi Van FWD CBZB		2610960L	Drive Shaft	36	59.5	40	800	
	2009.09-2014.05	AT	F	R	Combi Van FWD CBZB		2016530L	Drive Shaft	36	59.5	40.5	785	
	2013.04-2017.03	6MT	F	L	Combi Van FWD CJZA		2033730L	Drive Shaft	36	59.5	40	517	
	2013.04-2017.03	6MT	F	R	Combi Van FWD CJZA		2613070L	Drive Shaft	36	59.5	40	820	
	2013.04-2017.03	7DCT	F	L	Combi Van FWD CJZA		2612820L	Drive Shaft	36	59.5	40	523	
	2013.04-2017.03	7DCT	F	R	Combi Van FWD CJZA		2610960L	Drive Shaft	36	59.5	40	800	
	2013.04-2017.03	MT	F	L	Combi Van FWD CJZA		2032940L	Drive Shaft	36	59.5	40	517	
	2013.04-2017.03	MT	F	R	Combi Van FWD CJZA		2610420L	Drive Shaft	36	59.5	40	814	
	2013.04-2017.03	MT	F	R	Combi Van FWD CJZA		2610960L	Drive Shaft	36	59.5	40	800	
1.4 (90 kw)	2009.07-2014.05	AT	F	R	Combi Van FWD CAXA		2016530L	Drive Shaft	36	59.5	40.5	785	
	2009.07-2014.05	MT	F	R	Combi Van FWD CAXA		2610960L	Drive Shaft	36	59.5	40	800	
	2013.05-2017.03	6MT	F	R	Combi Van FWD CXSA		2613070L	Drive Shaft	36	59.5	40	820	
	2013.05-2017.03	6MT/7DCT	F	L	Combi Van FWD CXSA		2612820L	Drive Shaft	36	59.5	40	523	
	2013.05-2017.03	7DCT	F	R	Combi Van FWD CXSA		2610960L	Drive Shaft	36	59.5	40	800	
	2013.05-2017.03	7DCT	F	R	Combi Van FWD CXSA		2610960L	Drive Shaft	36	59.5	40	800	
1.4 (103 kw)	2013.05-2017.03	6MT	F	L	Combi Van FWD CHPA		2612820L	Drive Shaft	36	59.5	40	523	
	2013.05-2017.03	6MT	F	R	Combi Van FWD CHPA		2612830L	Drive Shaft	36	59.5	40	815	
	2013.05-2017.03	7DCT	F	L	Combi Van FWD CHPA		2611000L	Drive Shaft	36	59.5	40.5	514	
	2013.05-2017.03	7DCT	F	R	Combi Van FWD CHPA		2033130L	Drive Shaft	36	59.5	40.5	794	
	2013.05-2017.03	7DCT	F	R	Combi Van FWD CHPA		2610960L	Drive Shaft	36	59.5	40	800	
1.4 (118 kw)	2009.07-2012.10	AT	F	R	Combi Van FWD CAVD		2016530L	Drive Shaft	36	59.5	40.5	785	
	2009.07-2012.10	MT	F	L	Combi Van FWD CAVD		2612010L	Drive Shaft	36	59.5	40	536	
	2009.07-2012.10	MT	F	R	Combi Van FWD CAVD		2610960L	Drive Shaft	36	59.5	40	800	
	2009.12-2012.10	5MT	F	L	Combi Van FWD CAYB		2032940L	Drive Shaft	36	59.5	40	517	
1.6 (66 kw)	2009.12-2012.10	5MT	F	R	Combi Van FWD CAYB		2610420L	Drive Shaft	36	59.5	40	814	
	2013.05-2017.03	5MT	F	L	Combi Van FWD CLHB/CRKA/CXXA		2032940L	Drive Shaft	36	59.5	40	517	
	2013.05-2017.03	5MT	F	R	Combi Van FWD CLHB/CRKA/CXXA		2610420L	Drive Shaft	36	59.5	40	814	
	2013.05-2017.03	5MT	F	R	Combi Van FWD CLHB/CRKA/CXXA		2610420L	Drive Shaft	36	59.5	40	814	
	2013.05-2017.03	5MT	F	R	Combi Van FWD CLHB/CRKA/CXXA		2610420L	Drive Shaft	36	59.5	40	814	
1.6 (77 kw)	2013.05-2017.03	5MT	F	R	Combi Van FWD CLHA		2610420L	Drive Shaft	36	59.5	40	814	
	2013.05-2017.03	5MT	F	R	Combi Van FWD CLHA		2612830L	Drive Shaft	36	59.5	40	815	
	2013.05-2017.03	5MT/7DCT	F	L	Combi Van FWD CLHA		2612820L	Drive Shaft	36	59.5	40	523	
	2013.05-2017.03	7DCT	F	R	Combi Van FWD CLHA		2610960L	Drive Shaft	36	59.5	40	800	
1.6 (81 kw)	2013.05-2017.03	5MT	F	R	Combi Van FWD CRKB		2610420L	Drive Shaft	36	59.5	40	814	
	2013.05-2017.03	6MT	F	L	Combi Van FWD CRKB		2612820L	Drive Shaft	36	59.5	40	523	
	2013.05-2017.03	6MT	F	R	Combi Van FWD CRKB		2612830L	Drive Shaft	36	59.5	40	815	



	 YEAR	TRANSM.	F/R	L/R	BODY STYLE & DRIVE TYPE & ENGINE	REMARKS	GSP Ref.	 PRODUCT	 ABS	Technical Specifications				
										A	B	C	H	L
VW														
Golf Van (Variant)														
2.0 (103 kw)	2009.07-2014.05	AT	F	L	Combi Van FWD CBDB/CFHC		2540130L	Drive Shaft		36		59.5	40.5	482
	2009.07-2014.05	AT	F	R	Combi Van FWD CBDB/CFHC		2540110L	Drive Shaft		36		59.5	40.5	760
	2009.07-2014.05	MT	F	L	Combi Van FWD CBDB/CFHC		2032950L	Drive Shaft		36		59.5	40.5	486
	2009.07-2014.05	MT	F	R	Combi Van FWD CBDB/CFHC		2033130L	Drive Shaft		36		59.5	40.5	794
2.0 (110 kw)	2013.04-2017.03	6DCT	F	L	Combi Van FWD CRBC/CRLB		2612850L	Drive Shaft		36		59.5	40	472
	2013.04-2017.03	6DCT	F	R	Combi Van FWD CRBC/CRLB		2033540L	Drive Shaft		36		59.5	40	760
	2013.04-2017.03	6MT	F	R	Combi Van FWD CRBC/CRLB		2033130L	Drive Shaft		36		59.5	40.5	794
Grand California														
2.0 (130 kw)	2019.04-	6MT	F	L	Bus 4WD DAVA/DMZB		2039380L	Drive Shaft		44	42	72.4	109.5	722
	2019.04-	6MT/8AT	F	R	Bus 4WD DAVA/DMZB		2039360L	Drive Shaft		44	26	72.4	109.5	687
	2019.04-	8AT	F	L	Bus 4WD DAVA/DMZB		2039370L	Drive Shaft		44	42	72.4	109.5	707
	2019.04-	6MT	F	L	Bus FWD DAVA/DMZB		2039380L	Drive Shaft		44	42	72.4	109.5	722
	2019.04-	6MT/8AT	F	R	Bus FWD DAVA/DMZB		2039350L	Drive Shaft		44	42	72.4	109.5	1089
	2019.04-	8AT	F	L	Bus FWD DAVA/DMZB		2039370L	Drive Shaft		44	42	72.4	109.5	707
ID.3														
ET (107 kw)	2020.11-	ET	R	L	Hatchback RWD EBJC		2040930L	Drive Shaft		36	37	59.5	34	611
	2020.11-	ET	R	R	Hatchback RWD EBJC		2040920L	Drive Shaft		36	37	59.5	34	840
ET (110 kw)	2020.03-	ET	R	L	Hatchback RWD EBJD	Date from:2020.10	2040930L	Drive Shaft		36	37	59.5	34	611
	2020.03-	ET	R	R	Hatchback RWD EBJD	Date from:2020.10	2040920L	Drive Shaft		36	37	59.5	34	840
ET (150 kw)	2019.11-	ET	R	L	Hatchback RWD EBJA/EBJC	Date from:2020.10	2040930L	Drive Shaft		36	37	59.5	34	611
	2019.11-	ET	R	R	Hatchback RWD EBJA/EBJC	Date from:2020.10	2040920L	Drive Shaft		36	37	59.5	34	840
Jetta														
1.2 (77 kw)	2010.10-	DCT	F	R	Saloon FWD CBZB	Date To:2012.07	2016530L	Drive Shaft		36		59.5	40.5	785
	2010.10-	DCT	F	R	Saloon FWD CBZB	Date From:2014.10	2033130L	Drive Shaft		36		59.5	40.5	794
	2010.10-	MT	F	L	Saloon FWD CBZB		2612010L	Drive Shaft		36		59.5	40	536
	2010.10-	MT	F	R	Saloon FWD CBZB		2610960L	Drive Shaft		36		59.5	40	800
1.4 (90 kw)	2007.07-2010.10	6MT	F	R	Saloon FWD CAXA	For Modelcode:162/163	2610960L	Drive Shaft		36		59.5	40	800
	2007.07-2010.10	7DCT	F	R	Saloon FWD CAXA	Date From:2010.05	2016530L	Drive Shaft		36		59.5	40.5	785
	2007.07-2010.10	MT	F	L	Saloon FWD CAXA		2612010L	Drive Shaft		36		59.5	40	536
	2011.07-	6MT	F	R	Saloon FWD CAXA/CMSB	For Modelcode:162/163	2610960L	Drive Shaft		36		59.5	40	800
	2011.07-	7DCT	F	R	Saloon FWD CAXA/CMSB		2016530L	Drive Shaft		36		59.5	40.5	785
	2011.07-	MT	F	L	Saloon FWD CAXA/CMSB		2612010L	Drive Shaft		36		59.5	40	536
1.4 (92 kw)	2014.08-	DCT	F	R	Saloon FWD CZCA		2033130L	Drive Shaft		36		59.5	40.5	794
1.4 (103 kw)	2006.07-2008.06	6MT	F	L	Saloon FWD BMY		2612010L	Drive Shaft		36		59.5	40	536
	2006.07-2008.06	6MT	F	R	Saloon FWD BMY		2610960L	Drive Shaft		36		59.5	40	800
	2006.07-2008.06	AT	F	L	Saloon FWD BMY		2033800L	Drive Shaft		36		59.5	40	487
1.4 (110 kw)	2011.04-	6MT/7DCT	F	R	Saloon FWD CAVA/CTHA		2016530L	Drive Shaft		36		59.5	40.5	785
	2014.08-	DCT	F	R	Saloon FWD CZDA		2033130L	Drive Shaft		36		59.5	40.5	794
1.4 (118 kw)	2008.07-2010.10	6MT	F	L	Saloon FWD CAVD		2612010L	Drive Shaft		36		59.5	40	536
	2008.07-2010.10	6MT	F	R	Saloon FWD CAVD		2610960L	Drive Shaft		36		59.5	40	800
	2008.07-2010.10	7DCT	F	R	Saloon FWD CAVD		2016530L	Drive Shaft		36		59.5	40.5	785
	2011.04-	7DCT	F	R	Saloon FWD CAVD/CTHD		2016530L	Drive Shaft		36		59.5	40.5	785
1.4 (125 kw)	2006.07-2008.06	6MT	F	R	Saloon FWD BLG		2016530L	Drive Shaft		36		59.5	40.5	785
	2006.07-2008.06	AT	F	L	Saloon FWD BLG		2033800L	Drive Shaft		36		59.5	40	487
1.6 (63 kw)	2014.03-	MT	F	R	Saloon FWD CFNB	Date From:2015.10	2610960L	Drive Shaft		36		59.5	40	800
	2014.03-	MT	F	R	Saloon FWD CFNB	Date To:2015.09	2612110L	Drive Shaft		36		59.5	40.5	784
1.6 (66 kw)	2009.12-2010.10	5MT	F	L	Saloon FWD CAYB		2032940L	Drive Shaft		36		59.5	40	517
	2009.12-2010.10	5MT	F	R	Saloon FWD CAYB		2610420L	Drive Shaft		36		59.5	40	814
	2015.09-2018.04	5MT	F	R	Saloon FWD CWVB		2610960L	Drive Shaft		36		59.5	40	800
1.6 (75 kw)	2005.08-2010.10	5MT	F	R	Saloon FWD BSE/BSF/CCSA		2610960L	Drive Shaft		36		59.5	40	800
	2005.08-2010.10	6AT	F	R	Saloon FWD BSE/BSF/CCSA		2610940L	Drive Shaft		36	26	59.5	40	884
	2005.08-2010.10	7DCT	F	L	Saloon FWD BSE/BSF/CCSA		2032940L	Drive Shaft		36		59.5	40	517
	2005.08-2010.10	7DCT	F	R	Saloon FWD BSE/BSF/CCSA		2610420L	Drive Shaft		36		59.5	40	814
	2008.01-2010.10	5MT	F	R	Saloon FWD CCSA		2610960L	Drive Shaft		36		59.5	40	800
	2009.07-2010.10	5MT	F	L	Saloon FWD CAYC		2032940L	Drive Shaft		36		59.5	40	517
1.6 (77 kw)	2009.07-2010.10	5MT	F	R	Saloon FWD CAYC		2610420L	Drive Shaft		36		59.5	40	814
	2009.07-2010.10	7DCT	F	L	Saloon FWD CAYC		2611000L	Drive Shaft		36		59.5	40.5	514
	2009.07-2010.10	7DCT	F	R	Saloon FWD CAYC		2033130L	Drive Shaft		36		59.5	40.5	794
	2010.11-	5MT	F	L	Saloon FWD CAYC	Date to:2014.09	2032940L	Drive Shaft		36		59.5	40	517
	2010.11-	5MT	F	R	Saloon FWD CAYC		2610420L	Drive Shaft		36		59.5	40	814
	2010.11-	7DCT	F	L	Saloon FWD CAYC		2611000L	Drive Shaft		36		59.5	40.5	514
	2010.11-	7DCT	F	R	Saloon FWD CAYC		2033130L	Drive Shaft		36		59.5	40.5	794
	2011.12-	AT	F	R	Saloon FWD CFNA/CLRA		2610940L	Drive Shaft		36	26	59.5	40	884
	2011.12-	MT	F	R	Saloon FWD CFNA/CLRA		2612110L	Drive Shaft		36		59.5	40.5	784
	2015.09-	5MT	F	R	Saloon FWD CWVA		2610960L	Drive Shaft		36		59.5	40	800

	 YEAR	TRANSM.	F/R	L/R	BODY STYLE & DRIVE TYPE & ENGINE	REMARKS	GSP Ref.	 PRODUCT ABS	Technical Specifications						
									A	B	C	H	L		
VW Jetta															
1.6 (81 kw)	2015.09-	6AT	F	R	Saloon FWD CWVA	Date To:2016.03	2610940L	Drive Shaft		36	26	59.5	40	884	
1.6 (85 kw)	2005.09-2008.06	6MT	F	R	Saloon FWD BLF		2612110L	Drive Shaft		36		59.5	40.5	784	
	2005.09-2008.06	AT	F	R	Saloon FWD BLF		2610940L	Drive Shaft		36	26	59.5	40	884	
1.9 (77 kw)	2005.05-2010.10	5MT	F	L	Saloon FWD BKC/BLS/BXE		2032940L	Drive Shaft		36		59.5	40	517	
	2005.05-2010.10	5MT	F	R	Saloon FWD BKC/BLS/BXE		2610420L	Drive Shaft		36		59.5	40	814	
	2005.05-2010.10	6DCT	F	L	Saloon FWD BKC/BLS/BXE		2540130L	Drive Shaft		36		59.5	40.5	482	
	2005.05-2010.10	6DCT	F	R	Saloon FWD BKC/BLS/BXE		2540110L	Drive Shaft		36		59.5	40.5	760	
	2005.05-2010.10	7DCT	F	L	Saloon FWD BKC/BLS/BXE	chassis no. from:1K-9-091376.Date From:2008.12	2611000L	Drive Shaft		36		59.5	40.5	514	
	2005.05-2010.10	7DCT	F	R	Saloon FWD BKC/BLS/BXE	chassis no. from:1K-9-091376.Date From:2008.12	2033130L	Drive Shaft		36		59.5	40.5	794	
2.0 (81 kw)	2010.10-	6MT	F	R	Saloon FWD CLCA/CUUA	Date From:2010.05	2033130L	Drive Shaft		36		59.5	40.5	794	
	2010.10-	7DCT	F	L	Saloon FWD CLCA/CUUA		2611000L	Drive Shaft		36		59.5	40.5	514	
	2010.10-	MT	F	R	Saloon FWD CLCA/CUUA		2610420L	Drive Shaft		36		59.5	40	814	
2.0 (85 kw)	2010.06-2017.12	6AT	F	R	Saloon FWD CBPA		2610940L	Drive Shaft		36	26	59.5	40	884	
2.0 (100 kw)	2005.09-2010.10	6DCT	F	L	Saloon FWD AZV/CBDA		2540130L	Drive Shaft		36		59.5	40.5	482	
	2005.09-2010.10	6DCT	F	R	Saloon FWD AZV/CBDA		2540110L	Drive Shaft		36		59.5	40.5	760	
	2005.09-2010.10	6MT	F	L	Saloon FWD AZV/CBDA		2032950L	Drive Shaft		36		59.5	40.5	486	
	2005.09-2010.10	6MT	F	R	Saloon FWD AZV/CBDA		2033130L	Drive Shaft		36		59.5	40.5	794	
	2005.09-2010.10	MT	F	L	Saloon FWD AZV/CBDA		2033800L	Drive Shaft		36		59.5	40	487	
2.0 (103 kw)	2005.05-2010.10	6DCT	F	L	Saloon FWD BKD/CBDB/CJAA		2540130L	Drive Shaft		36		59.5	40.5	482	
	2005.05-2010.10	6DCT	F	R	Saloon FWD BKD/CBDB/CJAA		2540110L	Drive Shaft		36		59.5	40.5	760	
	2005.05-2010.10	6MT	F	L	Saloon FWD BKD/CBDB/CJAA		2032950L	Drive Shaft		36		59.5	40.5	486	
	2005.05-2010.10	6MT	F	R	Saloon FWD BKD/CBDB/CJAA		2033130L	Drive Shaft		36		59.5	40.5	794	
	2005.05-2010.10	MT	F	L	Saloon FWD BKD/CBDB/CJAA		2033800L	Drive Shaft		36		59.5	40	487	
	2005.10-2008.06	6DCT	F	L	Saloon FWD BMM		2540130L	Drive Shaft		36		59.5	40.5	482	
	2005.10-2008.06	6DCT	F	R	Saloon FWD BMM		2540110L	Drive Shaft		36		59.5	40.5	760	
	2005.10-2008.06	6MT	F	L	Saloon FWD BMM		2032950L	Drive Shaft		36		59.5	40.5	486	
	2005.10-2008.06	6MT	F	R	Saloon FWD BMM		2033130L	Drive Shaft		36		59.5	40.5	794	
	2005.10-2008.06	MT	F	L	Saloon FWD BMM		2033800L	Drive Shaft		36		59.5	40	487	
	2010.10-	5MT	F	L	Saloon FWD CFFB/CLCB	Inner teeth of wheel side:30	2032940L	Drive Shaft		36		59.5	40	517	
	2010.10-	5MT	F	L	Saloon FWD CFFB/CLCB	Inner teeth of wheel side:33	2612820L	Drive Shaft		36		59.5	40	523	
	2010.10-	5MT	F	R	Saloon FWD CFFB/CLCB	Inner teeth of wheel side:30	2610420L	Drive Shaft		36		59.5	40	814	
	2010.10-	5MT	F	R	Saloon FWD CFFB/CLCB	Inner teeth of wheel side:33	2612830L	Drive Shaft		36		59.5	40	815	
	2010.10-	AT	F	L	Saloon FWD CFFB/CLCB		2540130L	Drive Shaft		36		59.5	40.5	482	
	2010.10-	AT	F	R	Saloon FWD CFFB/CLCB		2540110L	Drive Shaft		36		59.5	40.5	760	
	2010.10-	MT	F	L	Saloon FWD CFFB/CLCB		2032950L	Drive Shaft		36		59.5	40.5	486	
	2010.10-	MT	F	R	Saloon FWD CFFB/CLCB		2033130L	Drive Shaft		36		59.5	40.5	794	
	2.0 (110 kw)	2005.05-2008.06	6AT	F	R	Saloon FWD BLR/BLY/BVY/BVZ		2610940L	Drive Shaft		36	26	59.5	40	884
		2005.05-2008.06	6MT	F	L	Saloon FWD BLR/BLY/BVY/BVZ		2032940L	Drive Shaft		36		59.5	40	517
2005.05-2008.06		6MT	F	R	Saloon FWD BLR/BLY/BVY/BVZ		2610420L	Drive Shaft		36		59.5	40	814	
2014.07-		AT	F	L	Saloon FWD CUUB/CVCA/DELA/DGMA		2540130L	Drive Shaft		36		59.5	40.5	482	
2014.07-		AT	F	R	Saloon FWD CUUB/CVCA/DELA/DGMA		2540110L	Drive Shaft		36		59.5	40.5	760	
2014.07-		MT	F	L	Saloon FWD CUUB/CVCA/DELA/DGMA		2032950L	Drive Shaft		36		59.5	40.5	486	
2014.07-		MT	F	R	Saloon FWD CUUB/CVCA/DELA/DGMA		2033130L	Drive Shaft		36		59.5	40.5	794	
2.0 (125 kw)	2006.06-2010.10	6DCT	F	L	Saloon FWD BMN/CEGA		2540130L	Drive Shaft		36		59.5	40.5	482	
	2006.06-2010.10	6DCT	F	R	Saloon FWD BMN/CEGA		2540110L	Drive Shaft		36		59.5	40.5	760	
	2006.06-2010.10	6MT	F	L	Saloon FWD BMN/CEGA		2033800L	Drive Shaft		36		59.5	40	487	
2.0 (147 kw)	2005.09-2010.10	6DCT	F	L	Saloon FWD BWA/CAWB/CBFA/CCTA		2032950L	Drive Shaft		36		59.5	40.5	486	
	2005.09-2010.10	6DCT	F	R	Saloon FWD BWA/CAWB/CBFA/CCTA		2016530L	Drive Shaft		36		59.5	40.5	785	
	2005.09-2010.10	AT/MT	F	L	Saloon FWD BWA/CAWB/CBFA/CCTA		2033800L	Drive Shaft		36		59.5	40	487	
	2010.10-2014.07	6DCT	F	L	Saloon FWD CBFA/CCTA/CCZA		2032950L	Drive Shaft		36		59.5	40.5	486	
	2010.10-2014.07	6DCT	F	R	Saloon FWD CBFA/CCTA/CCZA		2016530L	Drive Shaft		36		59.5	40.5	785	
2.0 (155 kw)	2012.12-2017.12	DCT	F	L	Saloon FWD CPLA/CPPA		2032950L	Drive Shaft		36		59.5	40.5	486	
2.5 (110 kw)	2005.01-2008.06	5MT	F	L	Saloon FWD BGP/BTK		2032940L	Drive Shaft		36		59.5	40	517	
Multivan															
1.9 (62 kw)	2006.01-2009.11	5MT	F	L	Bus FWD BRB	6 balls	2611050L	Drive Shaft		38		63	102.5	645	
1.9 (63 kw)	2005.06-2009.11	5MT	F	L	Bus FWD AXB	6 balls	2611050L	Drive Shaft		38		63	102.5	645	
1.9 (75 kw)	2006.01-2009.11	5MT	F	L	Bus FWD BRS	6 balls	2611050L	Drive Shaft		38		63	102.5	645	
1.9 (77 kw)	2003.04-2009.11	5MT	F	L	Bus FWD AXB	6 balls	2611050L	Drive Shaft		38		63	102.5	645	
2.0 (62 kw)	2009.09-2015.11	5MT	F	L	Bus FWD CAAA	6 balls	2611050L	Drive Shaft		38		63	102.5	645	
	2009.09-2015.11	5MT	F	R	Bus FWD CAAA		2032610L	Drive Shaft		38	26	63	102.5	857	
	2015.04-2019.07	5MT	F	L	Bus FWD CXGA	Date To:2017.03	2611050L	Drive Shaft		38		63	102.5	645	
2.0 (75 kw)	2009.09-2015.11	5MT	F	L	Bus FWD CAAB	6 balls	2611050L	Drive Shaft		38		63	102.5	645	
	2009.09-2015.11	5MT	F	R	Bus FWD CAAB		2032610L	Drive Shaft		38	26	63	102.5	857	
	2015.04-2019.12	5MT	F	L	Bus FWD CAAB/CXGB	Date To:2017.03	2611050L	Drive Shaft		38		63	102.5	645	
	2015.04-2019.12	5MT	F	R	Bus FWD CAAB/CXGB	Date To:2017.03	2032610L	Drive Shaft		38	26	63	102.5	857	



 YEAR	TRANSM.	F/R	L/R	BODY STYLE & DRIVE TYPE & ENGINE	REMARKS	GSP Ref.	 PRODUCT	 ABS	Technical Specifications					
									A	B	C	H	L	
VW Multivan														
2.0 (84 kw)	2011.05-2015.08	5MT	F	L	Bus FWD CAAD	6 balls	2611050L	Drive Shaft		38		63	102.5	645
	2011.05-2015.08	5MT	F	R	Bus FWD CAAD		2032610L	Drive Shaft		38	26	63	102.5	857
	2016.05-2019.08	5MT	F	L	Bus FWD CXHB	Date To:2017.03	2611050L	Drive Shaft		38		63	102.5	645
2.0 (85 kw)	2003.11-2015.11	5MT	F	L	Bus FWD AXA	6 balls	2611050L	Drive Shaft		38		63	102.5	645
2.0 (100 kw)	2010.05-2015.11	6MT	F	L	Bus 4WD CAAE/CCHB	Date From:2013.07	2033600L	Drive Shaft		38	42	63	102.5	617
	2010.05-2015.11	6MT	F	L	Bus 4WD CAAE/CCHB		2610840L	Drive Shaft		38	26	63	102.5	616
	2010.05-2015.11	6MT	F	R	Bus 4WD CAAE/CCHB	Date from:2013.07	2016660L	Drive Shaft		38	26	63	102.5	616
	2010.05-2015.11	6MT	F	R	Bus 4WD CAAE/CCHB	Date to:2013.06	2610840L	Drive Shaft		38	26	63	102.5	616
	2010.05-2015.11	6MT	R	L	Bus 4WD CAAE/CCHB		2612570L	Drive Shaft		38		59	102	683
	2010.05-2015.11	6MT	R	R	Bus 4WD CAAE/CCHB		2612580L	Drive Shaft		38		59	102	743
	2010.05-2015.11	6MT	F	L	Bus FWD CAAE/CCHB	Date From:2013.07	2033600L	Drive Shaft		38	42	63	102.5	617
	2010.05-2015.11	6MT	F	L	Bus FWD CAAE/CCHB	Date to:2013.06	2610840L	Drive Shaft		38	26	63	102.5	616
	2010.05-2015.11	6MT	F	R	Bus FWD CAAE/CCHB	Date From:2013.07,Date To:2015.04	2023610L	Drive Shaft		38	26	63	102.5	879
	2010.05-2015.11	6MT	F	R	Bus FWD CAAE/CCHB		2032960L	Drive Shaft		38	26	63	102.5	880
	2010.05-2015.11	6MT	F	R	Bus FWD CAAE/CCHB	Date From:2015.05	2033610L	Drive Shaft		38	26	63	102.5	881
	2010.05-2015.11	7DCT	F	L	Bus FWD CAAE/CCHB		2032930L	Drive Shaft		38	37	63	102.5	647
	2010.05-2015.11	7DCT	F	R	Bus FWD CAAE/CCHB	Chassis no. from:7HC5000001/7HC4500001/7HC3000001	2023920L	Drive Shaft		38	37	63	102.5	1026
	2010.05-2015.11	7DCT	F	R	Bus FWD CAAE/CCHB	Chassis no. to:7HB2500000/7HB4500000/7HB3500000	2033530L	Drive Shaft		38	37	63	102.5	1026
2.0 (103 kw)	2009.09-2015.11	6MT	F	L	Bus 4WD CAAC/CCHA	Date From:2013.07	2033600L	Drive Shaft		38	42	63	102.5	617
	2009.09-2015.11	6MT	F	L	Bus 4WD CAAC/CCHA		2610840L	Drive Shaft		38	26	63	102.5	616
	2009.09-2015.11	6MT	F	R	Bus 4WD CAAC/CCHA	Date from:2013.07	2016660L	Drive Shaft		38	26	63	102.5	616
	2009.09-2015.11	6MT	F	R	Bus 4WD CAAC/CCHA	Date to:2013.06	2610840L	Drive Shaft		38	26	63	102.5	616
	2009.09-2015.11	AT	F	L	Bus 4WD CAAC/CCHA		2032930L	Drive Shaft		38	37	63	102.5	647
	2009.09-2015.11	AT	F	R	Bus 4WD CAAC/CCHA		2033530L	Drive Shaft		38	37	63	102.5	1026
	2009.09-2015.11	6MT	R	L	Bus 4WD CAAC/CCHA		2612570L	Drive Shaft		38		59	102	683
	2009.09-2015.11	6MT	R	R	Bus 4WD CAAC/CCHA		2612580L	Drive Shaft		38		59	102	743
	2009.09-2015.11	6MT	F	L	Bus FWD CAAC/CCHA	Date From:2013.07	2033600L	Drive Shaft		38	42	63	102.5	617
	2009.09-2015.11	6MT	F	L	Bus FWD CAAC/CCHA	Date to:2013.06	2610840L	Drive Shaft		38	26	63	102.5	616
	2009.09-2015.11	6MT	F	R	Bus FWD CAAC/CCHA	Date From:2013.07,Date To:2015.04	2023610L	Drive Shaft		38	26	63	102.5	879
	2009.09-2015.11	6MT	F	R	Bus FWD CAAC/CCHA		2032960L	Drive Shaft		38	26	63	102.5	880
	2009.09-2015.11	6MT	F	R	Bus FWD CAAC/CCHA	Date From:2015.05	2033610L	Drive Shaft		38	26	63	102.5	881
	2009.09-2015.11	7DCT	F	L	Bus FWD CAAC/CCHA		2032930L	Drive Shaft		38	37	63	102.5	647
	2009.09-2015.11	7DCT	F	R	Bus FWD CAAC/CCHA	Chassis no. from:7HC5000001/7HC4500001/7HC3000001	2023920L	Drive Shaft		38	37	63	102.5	1026
	2009.09-2015.11	7DCT	F	R	Bus FWD CAAC/CCHA	Chassis no. to:7HB2500000/7HB4500000/7HB3500000	2033530L	Drive Shaft		38	37	63	102.5	1026
	2015.04-2019.12	6MT	F	L	Bus FWD CAAC	Date To:2017.01	2033600L	Drive Shaft		38	42	63	102.5	617
	2015.04-2019.12	6MT	F	L	Bus FWD CAAC	Date to:2017.01	2610840L	Drive Shaft		38	26	63	102.5	616
	2015.04-2019.12	6MT	F	R	Bus FWD CAAC	Date To:2017.01	2033610L	Drive Shaft		38	26	63	102.5	881
	2015.04-2019.12	7DCT	F	L	Bus FWD CAAC		2032930L	Drive Shaft		38	37	63	102.5	647
	2015.04-2019.12	7DCT	F	R	Bus FWD CAAC		2032920L	Drive Shaft		38	37	63	102.5	1026
	2015.06-2019.12	6MT	F	L	Bus 4WD CAAC	Date To:2017.01	2033600L	Drive Shaft		38	42	63	102.5	617
	2015.06-2019.12	6MT	F	L	Bus 4WD CAAC	Date to:2017.01	2610840L	Drive Shaft		38	26	63	102.5	616
	2015.06-2019.12	6MT	F	R	Bus 4WD CAAC	Date to:2017.01	2016660L	Drive Shaft		38	26	63	102.5	616
	2015.06-2019.12	AT	F	L	Bus 4WD CAAC		2032930L	Drive Shaft		38	37	63	102.5	647
	2015.06-2019.12	6MT	R	L	Bus 4WD CAAC		2612570L	Drive Shaft		38		59	102	683
	2015.06-2019.12	6MT	R	R	Bus 4WD CAAC	Date To:2016.04	2612580L	Drive Shaft		38		59	102	743
2.0 (110 kw)	2012.07-2015.11	6MT	F	L	Bus FWD CJKB	Date From:2013.07	2033600L	Drive Shaft		38	42	63	102.5	617
	2012.07-2015.11	6MT	F	L	Bus FWD CJKB		2610840L	Drive Shaft		38	26	63	102.5	616
	2012.07-2015.11	6MT	F	R	Bus FWD CJKB	Date From:2013.07,Date To:2015.04	2023610L	Drive Shaft		38	26	63	102.5	879
	2012.07-2015.11	6MT	F	R	Bus FWD CJKB	Date To:2013.06	2032960L	Drive Shaft		38	26	63	102.5	880
	2012.07-2015.11	6MT	F	R	Bus FWD CJKB	Date From:2015.05	2033610L	Drive Shaft		38	26	63	102.5	881
	2015.04-	6MT	F	L	Bus FWD CXFA/CXHA/DNAA	Date To:2017.01	2033600L	Drive Shaft		38	42	63	102.5	617
	2015.04-	6MT	F	R	Bus FWD CXFA/CXHA/DNAA	Date To:2017.01	2033610L	Drive Shaft		38	26	63	102.5	881
	2015.04-	7DCT	F	L	Bus FWD CXFA/CXHA/DNAA		2032930L	Drive Shaft		38	37	63	102.5	647
	2015.04-	7DCT	F	R	Bus FWD CXFA/CXHA/DNAA		2023920L	Drive Shaft		38	37	63	102.5	1026
	2015.04-	7DCT	F	R	Bus FWD CXFA/CXHA/DNAA	For Model code:SGF/SGM/SGN	2033530L	Drive Shaft		38	37	63	102.5	1026
	2015.04-2019.07	6MT	F	L	Bus FWD CJKB	Outer teeth of transm.side:42	2033600L	Drive Shaft		38	42	63	102.5	617
	2015.04-2019.07	6MT	F	L	Bus FWD CJKB	Date to:2017.01	2610840L	Drive Shaft		38	26	63	102.5	616
	2015.04-2019.07	6MT	F	R	Bus FWD CJKB		2033610L	Drive Shaft		38	26	63	102.5	881
	2015.08-	6MT	F	L	Bus 4WD CXFA/CXHA/DNAA	Date To:2017.01	2033600L	Drive Shaft		38	42	63	102.5	617
	2015.08-	6MT	F	R	Bus 4WD CXFA/CXHA/DNAA	Date to:2017.01,Model code:SGF/SGM/SGN	2016660L	Drive Shaft		38	26	63	102.5	616
	2015.08-	7DCT	F	L	Bus 4WD CXFA/CXHA/DNAA		2032930L	Drive Shaft		38	37	63	102.5	647
	2015.08-	7DCT	F	R	Bus 4WD CXFA/CXHA/DNAA		2016650L	Drive Shaft		38	26	63	102.5	614
	2015.08-	6MT/7DCT	R	L	Bus 4WD CXFA/CXHA/DNAA		2612570L	Drive Shaft		38		59	102	683
	2015.08-	6MT/7DCT	R	R	Bus 4WD CXFA/CXHA/DNAA	Date To:2016.04	2612580L	Drive Shaft		38		59	102	743
2.0 (132 kw)	2009.09-2015.11	6MT	F	L	Bus FWD CFCA	Date From:2013.07	2033600L	Drive Shaft		38	42	63	102.5	617



YEAR	TRANSM.	F/R	L/R	BODY STYLE & DRIVE TYPE & ENGINE	REMARKS	GSP Ref.	PRODUCT	ABS	Technical Specifications				
									A	B	C	H	L
VW Multivan													
2.0 (132 kw)													
2009.09-2015.11	6MT	F	L	Bus FWD CFCA	Date to:2013.06	2610840L	Drive Shaft		38	26	63	102.5	616
2009.09-2015.11	6MT	F	R	Bus FWD CFCA	Date From:2013.07,Date To:2015.04	2023610L	Drive Shaft		38	26	63	102.5	879
2009.09-2015.11	6MT	F	R	Bus FWD CFCA		2032960L	Drive Shaft		38	26	63	102.5	880
2009.09-2015.11	6MT	F	R	Bus FWD CFCA	Date From:2015.05	2033610L	Drive Shaft		38	26	63	102.5	881
2009.09-2015.11	7DCT	F	L	Bus FWD CFCA		2032930L	Drive Shaft		38	37	63	102.5	647
2009.09-2015.11	7DCT	F	R	Bus FWD CFCA	Chassis no. From:7HC000001/7HC400000/7HC000001	2023920L	Drive Shaft		38	37	63	102.5	1026
2009.09-2015.11	7DCT	F	R	Bus FWD CFCA	Chassis no. To:7HB0500000/7HB4500000/7HBX500000	2033530L	Drive Shaft		38	37	63	102.5	1026
2010.01-2015.11	6MT	F	L	Bus 4WD CFCA	Date From:2013.07	2033600L	Drive Shaft		38	42	63	102.5	617
2010.01-2015.11	6MT	F	L	Bus 4WD CFCA		2610840L	Drive Shaft		38	26	63	102.5	616
2010.01-2015.11	6MT	F	R	Bus 4WD CFCA	Date from:2013.07	2016660L	Drive Shaft		38	26	63	102.5	616
2010.01-2015.11	6MT	F	R	Bus 4WD CFCA	Date to:2013.06	2610840L	Drive Shaft		38	26	63	102.5	616
2010.01-2015.11	7DCT	F	L	Bus 4WD CFCA		2032930L	Drive Shaft		38	37	63	102.5	647
2010.01-2015.11	7DCT	F	R	Bus 4WD CFCA	8 balls	2016650L	Drive Shaft		38	26	63	102.5	614
2010.01-2015.11	6MT/7DCT	R	L	Bus 4WD CFCA		2612570L	Drive Shaft		38		59	102	683
2010.01-2015.11	6MT/7DCT	R	R	Bus 4WD CFCA		2612580L	Drive Shaft		38		59	102	743
2015.04-2019.12	7AT	F	L	Bus 4WD CFCA		2032930L	Drive Shaft		38	37	63	102.5	647
2015.04-2019.12	7AT	F	R	Bus 4WD CFCA		2016650L	Drive Shaft		38	26	63	102.5	614
2015.04-2019.12	7DCT	R	L	Bus 4WD CFCA		2612570L	Drive Shaft		38		59	102	683
2015.04-2019.12	7DCT	R	R	Bus 4WD CFCA	Date To:2016.04	2612580L	Drive Shaft		38		59	102	743
2015.04-2019.12	7AT	F	L	Bus FWD CFCA		2032930L	Drive Shaft		38	37	63	102.5	647
2015.04-2019.12	7AT	F	R	Bus FWD CFCA		2023920L	Drive Shaft		38	37	63	102.5	1026
2.0 (146 kw)													
2018.08-	7DCT	F	L	Bus 4WD CXEC	Date To:2020.11	2034970L	Drive Shaft		38	37	63	103	646
2018.08-	7DCT	R	L	Bus 4WD CXEC		2612570L	Drive Shaft		38		59	102	683
2018.08-	7DCT	F	L	Bus FWD CXEC	Date To:2020.11	2034970L	Drive Shaft		38	37	63	103	646
2018.08-	7DCT	F	R	Bus FWD CXEC	Date To:2020.11	2034960L	Drive Shaft		38	37	63	103	1025
2.0 (150 kw)													
2011.05-2015.11	6MT	F	L	Bus FWD CJKA	Date From:2013.07	2033600L	Drive Shaft		38	42	63	102.5	617
2011.05-2015.11	6MT	F	L	Bus FWD CJKA	Date to:2013.06	2610840L	Drive Shaft		38	26	63	102.5	616
2011.05-2015.11	6MT	F	R	Bus FWD CJKA	Date From:2013.07,Date To:2015.04	2023610L	Drive Shaft		38	26	63	102.5	879
2011.05-2015.11	6MT	F	R	Bus FWD CJKA	Date To:2013.06	2032960L	Drive Shaft		38	26	63	102.5	880
2011.05-2015.11	6MT	F	R	Bus FWD CJKA	Date From:2015.05	2033610L	Drive Shaft		38	26	63	102.5	881
2011.05-2015.11	7DCT	F	L	Bus FWD CJKA		2032930L	Drive Shaft		38	37	63	102.5	647
2011.05-2015.11	7DCT	F	R	Bus FWD CJKA		2023920L	Drive Shaft		38	37	63	102.5	1026
2011.07-2015.11	7DCT	F	L	Bus 4WD CJKA		2032930L	Drive Shaft		38	37	63	102.5	647
2011.07-2015.11	7DCT	F	R	Bus 4WD CJKA		2016650L	Drive Shaft		38	26	63	102.5	614
2011.07-2015.11	7DCT	R	L	Bus 4WD CJKA		2612570L	Drive Shaft		38		59	102	683
2011.07-2015.11	7DCT	R	R	Bus 4WD CJKA		2612580L	Drive Shaft		38		59	102	743
2015.04-2019.07	7AT	F	L	Bus FWD CJKA		2032930L	Drive Shaft		38	37	63	102.5	647
2015.04-2019.07	7AT	F	R	Bus FWD CJKA		2023920L	Drive Shaft		38	37	63	102.5	1026
2015.06-	7DCT	F	L	Bus 4WD CXEB/DMZA	Date From:2017.02,Date To:2020.11	2034970L	Drive Shaft		38	37	63	103	646
2015.06-	6MT/7DCT	R	L	Bus 4WD CXEB/DMZA		2612570L	Drive Shaft		38		59	102	683
2015.06-	6MT/7DCT	R	R	Bus 4WD CXEB/DMZA	Date To:2016.04	2612580L	Drive Shaft		38		59	102	743
2015.06-	7DCT	F	L	Bus FWD CXEB/DMZA	Date To:2020.11,For Modelcode:SHM/SHN	2034970L	Drive Shaft		38	37	63	103	646
2015.06-	7DCT	F	L	Bus FWD CXEB/DMZA	Date From:2017.02,For Modelcode:SGF/SGM/SGN	2611050L	Drive Shaft		38		63	102.5	645
2015.06-	7DCT	F	R	Bus FWD CXEB/DMZA	For Modelcode:SGF/SGM/SGN	2034960L	Drive Shaft		38	37	63	103	1025
2015.06-2019.07	7AT	F	L	Bus 4WD CJKA		2032930L	Drive Shaft		38	37	63	102.5	647
2015.06-2019.07	7AT	F	R	Bus 4WD CJKA		2016650L	Drive Shaft		38	26	63	102.5	614
2015.06-2019.07	7DCT	R	L	Bus 4WD CJKA		2612570L	Drive Shaft		38		59	102	683
2015.06-2019.07	7DCT	R	R	Bus 4WD CJKA	Date To:2016.04	2612580L	Drive Shaft		38		59	102	743
2.5 (96 kw)													
2003.04-2009.11	6MT	F	L	Bus FWD AXD/BNZ		2610840L	Drive Shaft		38	26	63	102.5	616
2004.07-2009.11	6MT	F	L	Bus 4WD AXD/BNZ		2610840L	Drive Shaft		38	26	63	102.5	616
2004.07-2009.11	6MT	R	L	Bus 4WD AXD/BNZ		2612570L	Drive Shaft		38		59	102	683
2004.07-2009.11	6MT	R	R	Bus 4WD AXD/BNZ		2612580L	Drive Shaft		38		59	102	743
2.5 (120 kw)													
2003.11-2009.11	6MT	F	L	Bus FWD BLJ		2610840L	Drive Shaft		38	26	63	102.5	616
2.5 (128 kw)													
2003.04-2009.11	6MT	F	L	Bus FWD AXE/BPC		2610840L	Drive Shaft		38	26	63	102.5	616
2004.07-2009.11	6MT	F	L	Bus 4WD AXE/BPC		2610840L	Drive Shaft		38	26	63	102.5	616
2004.07-2009.11	6MT	R	L	Bus 4WD AXE/BPC		2612570L	Drive Shaft		38		59	102	683
2004.07-2009.11	6MT	R	R	Bus 4WD AXE/BPC		2612580L	Drive Shaft		38		59	102	743
3.2 (173 kw)													
2004.07-2009.12	6MT	R	L	Bus 4WD BKK/CFLA		2612570L	Drive Shaft		38		59	102	683
2004.07-2009.12	6MT	R	R	Bus 4WD BKK/CFLA		2612580L	Drive Shaft		38		59	102	743
Passat													
1.4 (90 kw)													
2007.05-2010.07	AT	F	L	Saloon FWD CAXA	Date From:2008.11	2612810L	Drive Shaft		36		59.5	40.5	525
2007.05-2010.07	AT	F	R	Saloon FWD CAXA	Date From:2008.11	2016530L	Drive Shaft		36		59.5	40.5	785
2007.05-2010.07	MT	F	L	Saloon FWD CAXA		2612010L	Drive Shaft		36		59.5	40	536
2007.05-2010.07	MT	F	R	Saloon FWD CAXA		2610960L	Drive Shaft		36		59.5	40	800
2010.08-2014.12	6MT/7DCT	F	L	Saloon FWD CAXA		2612010L	Drive Shaft		36		59.5	40	536



 YEAR	TRANSM.	F/R	L/R	BODY STYLE & DRIVE TYPE & ENGINE	REMARKS	GSP Ref.	 PRODUCT ABS	Technical Specifications								
								A	B	C	H	L				
VW																
Passat																
1.4 (90 kw)	2010.08-2014.12	6MT/7DCT	F	R	Saloon FWD CAXA		2610960L	Drive Shaft		36		59.5	40	800		
1.4 (92 kw)	2014.11-	7DCT	F	L	Saloon FWD CZCA		2612010L	Drive Shaft		36		59.5	40	536		
1.4 (110 kw)	2009.01-2010.11	6MT	F	R	Saloon FWD CDGA		2610960L	Drive Shaft		36		59.5	40	800		
	2009.01-2010.11	AT	F	L	Saloon FWD CDGA		2612810L	Drive Shaft		36		59.5	40.5	525		
	2009.01-2010.11	AT	F	R	Saloon FWD CDGA		2016530L	Drive Shaft		36		59.5	40.5	785		
	2009.01-2010.11	MT/6MT	F	L	Saloon FWD CDGA		2612010L	Drive Shaft		36		59.5	40	536		
	2010.09-2014.12	6MT	F	L	Saloon FWD CDGA		2612010L	Drive Shaft		36		59.5	40	536		
	2010.09-2014.12	6MT	F	R	Saloon FWD CDGA		2610960L	Drive Shaft		36		59.5	40	800		
	2010.09-2014.12	7DCT	F	L	Saloon FWD CDGA		2612810L	Drive Shaft		36		59.5	40.5	525		
	2010.09-2014.12	7DCT	F	R	Saloon FWD CDGA		2016530L	Drive Shaft		36		59.5	40.5	785		
	2014.08-	6MT	F	L	Saloon 4WD CZEA		2018960L	Drive Shaft		36		59.5	40	500		
	2014.08-	7DCT	F	R	Saloon FWD CZDA/CZEA		2613410L	Drive Shaft		36		59.5	40.5	806		
1.4 (118 kw)	2010.11-2014.12	6MT	F	L	Saloon FWD CKMA		2612010L	Drive Shaft		36		59.5	40	536		
	2010.11-2014.12	6MT	F	R	Saloon FWD CKMA		2610960L	Drive Shaft		36		59.5	40	800		
	2010.11-2014.12	7DCT	F	L	Saloon FWD CKMA		2612810L	Drive Shaft		36		59.5	40.5	525		
	2010.11-2014.12	7DCT	F	R	Saloon FWD CKMA		2016530L	Drive Shaft		36		59.5	40.5	785		
	2012.11-2014.12	6MT	F	L	Saloon FWD CTHD		2612010L	Drive Shaft		36		59.5	40	536		
	2012.11-2014.12	6MT	F	R	Saloon FWD CTHD		2610960L	Drive Shaft		36		59.5	40	800		
	2012.11-2014.12	7DCT	F	L	Saloon FWD CTHD		2612810L	Drive Shaft		36		59.5	40.5	525		
1.6 (75 kw)	2005.05-2010.11	5MT	F	L	Saloon FWD BSE/BSF		2033730L	Drive Shaft		36		59.5	40	517		
	2005.05-2010.11	5MT	F	R	Saloon FWD BSE/BSF		2610420L	Drive Shaft		36		59.5	40	814		
	2005.05-2010.11	AT	F	R	Saloon FWD BSE/BSF		2610940L	Drive Shaft		36	26	59.5	40	884		
	1.6 (77 kw)	2009.08-2010.11	5MT	F	L	Saloon FWD CAYC		2612820L	Drive Shaft		36		59.5	40	523	
		2009.08-2010.11	5MT	F	R	Saloon FWD CAYC		2612830L	Drive Shaft		36		59.5	40	815	
1.6 (77 kw)	2009.08-2010.11	MT	F	L	Saloon FWD CAYC		2032940L	Drive Shaft		36		59.5	40	517		
	2009.08-2010.11		F	R	Saloon FWD CAYC	Date From:2009.11	2610420L	Drive Shaft		36		59.5	40	814		
	2010.08-2014.12	6MT	F	L	Saloon FWD CAYC		2612820L	Drive Shaft		36		59.5	40	523		
	2010.08-2014.12	6MT	F	R	Saloon FWD CAYC		2612830L	Drive Shaft		36		59.5	40	815		
	2010.08-2014.12	7DCT	F	L	Saloon FWD CAYC		2611000L	Drive Shaft		36		59.5	40.5	514		
	2010.08-2014.12	7DCT	F	R	Saloon FWD CAYC		2033130L	Drive Shaft		36		59.5	40.5	794		
	2010.08-2014.12	MT	F	L	Saloon FWD CAYC		2032940L	Drive Shaft		36		59.5	40	517		
	2010.08-2014.12		F	R	Saloon FWD CAYC	Date From:2009.11	2610420L	Drive Shaft		36		59.5	40	814		
	1.6 (85 kw)	2005.03-2008.06	MT	F	L	Saloon FWD BLF		2612010L	Drive Shaft		36		59.5	40	536	
		2005.03-2008.06	MT	F	R	Saloon FWD BLF		2610960L	Drive Shaft		36		59.5	40	800	
1.6 (88 kw)	2014.08-	6MT/7DCT	F	L	Saloon FWD DCXA/DCZA		2612010L	Drive Shaft		36		59.5	40	536		
	2014.08-	7DCT	F	R	Saloon FWD DCXA/DCZA		2612830L	Drive Shaft		36		59.5	40	815		
1.8 (112 kw)	2008.11-2010.07	7AT	F	L	Saloon FWD CDAB/CGYA		2611000L	Drive Shaft		36		59.5	40.5	514		
	2008.11-2010.07	7AT	F	R	Saloon FWD CDAB/CGYA		2033130L	Drive Shaft		36		59.5	40.5	794		
	2008.11-2010.07	MT	F	L	Saloon FWD CDAB/CGYA	For Engine Code:CDAB,For PR code:0EN	2032950L	Drive Shaft		36		59.5	40.5	486		
	2008.11-2010.07	MT	F	L	Saloon FWD CDAB/CGYA	For Engine Code:CDAB,For PR code:0EJ	2611000L	Drive Shaft		36		59.5	40.5	514		
	2008.11-2010.07	MT	F	R	Saloon FWD CDAB/CGYA	For Engine Code:CDAB,For PR code:0EN	2033130L	Drive Shaft		36		59.5	40.5	794		
	2008.11-2010.07	MT	F	R	Saloon FWD CDAB/CGYA	For Engine Code:CDAB,For PR code:0EJ	2613410L	Drive Shaft		36		59.5	40.5	806		
	2011.02-2014.12	6MT	F	L	Saloon FWD CDAB	For PR code:A8T	2032950L	Drive Shaft		36		59.5	40.5	486		
	2011.02-2014.12	6MT	F	L	Saloon FWD CDAB	For PR code:A8B/A8C/A8G/A9I	2611000L	Drive Shaft		36		59.5	40.5	514		
	2011.02-2014.12	6MT	F	R	Saloon FWD CDAB	For PR code:A8T	2033130L	Drive Shaft		36		59.5	40.5	794		
	2011.02-2014.12	6MT	F	R	Saloon FWD CDAB	For PR code:A8B/A8C/A8G/A9I	2613410L	Drive Shaft		36		59.5	40.5	806		
	2011.02-2014.12	7DCT	F	L	Saloon FWD CDAB		2611000L	Drive Shaft		36		59.5	40.5	514		
	2011.02-2014.12	7DCT	F	R	Saloon FWD CDAB		2033130L	Drive Shaft		36		59.5	40.5	794		
	1.8 (118 kw)	2007.05-2010.11	7AT	F	R	Saloon FWD BZB/CDA	Date From:2009.01,For Engine Code:BZB/CDA	2033130L	Drive Shaft		36		59.5	40.5	794	
2007.05-2010.11		MT	F	L	Saloon FWD BZB/CDA	For Engine Code:CDA,For PR code:0EN	2032950L	Drive Shaft		36		59.5	40.5	486		
2007.05-2010.11		MT	F	R	Saloon FWD BZB/CDA	For Engine Code:CDA,For PR code:0EN	2033130L	Drive Shaft		36		59.5	40.5	794		
2007.05-2010.11		MT	F	R	Saloon FWD BZB/CDA	For Engine Code:BZB/CDA,For PR code:0EJ	2613410L	Drive Shaft		36		59.5	40.5	806		
2007.05-2010.11		MT/7AT	F	L	Saloon FWD BZB/CDA	For Engine Code:BZB/CDA,For PR code:0EJ,Data From:2009.01	2611000L	Drive Shaft		36		59.5	40.5	514		
2010.08-2014.12		6MT	F	L	Saloon FWD CDA	For PR code:A8T	2032950L	Drive Shaft		36		59.5	40.5	486		
2010.08-2014.12		6MT	F	L	Saloon FWD CDA	For PR code:A8B/A8C/A8G/A9I	2611000L	Drive Shaft		36		59.5	40.5	514		
2010.08-2014.12		6MT	F	R	Saloon FWD CDA	For PR code:A8B/A8C/A8G/A9I	2613410L	Drive Shaft		36		59.5	40.5	806		
2010.08-2014.12		7DCT	F	L	Saloon FWD CDA		2611000L	Drive Shaft		36		59.5	40.5	514		
2010.08-2014.12		7DCT	F	R	Saloon FWD CDA		2033130L	Drive Shaft		36		59.5	40.5	794		
1.8 (132 kw)	2015.02-	6MT	F	L	Saloon FWD CJS/CJSC		2611000L	Drive Shaft		36		59.5	40.5	514		
	2015.02-	6MT/7DCT	F	R	Saloon FWD CJS/CJSC		2613410L	Drive Shaft		36		59.5	40.5	806		
1.9 (77 kw)	2005.03-2010.07	AT	F	L	Saloon FWD BKC/BLS/BXE		2540130L	Drive Shaft		36		59.5	40.5	482		
	2005.03-2010.07	AT	F	R	Saloon FWD BKC/BLS/BXE		2540110L	Drive Shaft		36		59.5	40.5	760		
	2005.03-2010.07	MT	F	L	Saloon FWD BKC/BLS/BXE		2032940L	Drive Shaft		36		59.5	40	517		
	2005.03-2010.07	MT	F	R	Saloon FWD BKC/BLS/BXE		2610420L	Drive Shaft		36		59.5	40	814		
2.0 (81 kw)	2008.11-2010.11	5MT	F	L	Saloon FWD CBDC	With steel rim,With alloy rim	2612820L	Drive Shaft		36		59.5	40	523		



 YEAR	TRANSM.	F/R	L/R	BODY STYLE & DRIVE TYPE & ENGINE	REMARKS	GSP Ref.	 PRODUCT ABS	Technical Specifications					
								A	B	C	H	L	
VW													
Passat													
2.0 (81 kw)	2008.11-2010.11	5MT	F	R	Saloon FWD CBDC		2612830L	Drive Shaft	36	59.5	40	815	
	2008.11-2010.11	MT	F	L	Saloon FWD CBDC		2032940L	Drive Shaft	36	59.5	40	517	
	2008.11-2010.11		F	R	Saloon FWD CBDC	Date From:2009.11	2610420L	Drive Shaft	36	59.5	40	814	
2.0 (88 kw)	2005.11-2007.05	AT	F	L	Saloon FWD BWV		2540130L	Drive Shaft	36	59.5	40.5	482	
	2005.11-2007.05	AT	F	R	Saloon FWD BWV		2540110L	Drive Shaft	36	59.5	40.5	760	
	2005.11-2007.05	MT	F	L	Saloon FWD BWV		2032950L	Drive Shaft	36	59.5	40.5	486	
	2005.11-2007.05	MT	F	R	Saloon FWD BWV		2033130L	Drive Shaft	36	59.5	40.5	794	
	2005.11-2007.05	MT	F	R	Saloon FWD BWV		2033800L	Drive Shaft	36	59.5	40	487	
2.0 (90 kw)	2005.06-2006.05	AT	F	L	Saloon FWD BVE		2540130L	Drive Shaft	36	59.5	40.5	482	
	2005.06-2006.05	AT	F	R	Saloon FWD BVE		2540110L	Drive Shaft	36	59.5	40.5	760	
	2005.06-2006.05	MT	F	L	Saloon FWD BVE		2032950L	Drive Shaft	36	59.5	40.5	486	
	2005.06-2006.05	MT	F	L	Saloon FWD BVE		2033800L	Drive Shaft	36	59.5	40	487	
	2005.06-2006.05	MT	F	R	Saloon FWD BVE		2033130L	Drive Shaft	36	59.5	40.5	794	
2.0 (100 kw)	2003.11-2005.12	MT	F	L	Saloon FWD BGW/BHW		2033800L	Drive Shaft	36	59.5	40	487	
	2005.03-2010.11	AT	F	L	Saloon FWD BMA/CBAA	Date From:2008.01.For PR code:F4E/FSF/FBL.For 18axls	2033810L	Drive Shaft	36	59.5	40	485	
	2005.03-2010.11	AT	F	L	Saloon FWD BMA/CBAA	Date From:2007.12.For PR code:F4E/FSF/FBL.For 18axls	2540130L	Drive Shaft	36	59.5	40.5	482	
	2005.03-2010.11	AT	F	L	Saloon FWD BMA/CBAA	Date To:2007.12.For PR code:F4E/FSF/FBL.For 18axls	2540130L	Drive Shaft	36	59.5	40.5	482	
	2005.03-2010.11	AT	F	R	Saloon FWD BMA/CBAA	Date From:2007.12.For PR code:F4E/FSF/FBL.For 18axls	2540110L	Drive Shaft	36	59.5	40.5	760	
	2005.03-2010.11	MT	F	L	Saloon FWD BMA/CBAA	Date From:2007.03.For PR code:F4E/FSF/FBL.For 18axls	2032950L	Drive Shaft	36	59.5	40.5	486	
	2005.03-2010.11	MT	F	L	Saloon FWD BMA/CBAA	Date To:2007.03.For PR code:F4E/FSF/FBL.For 18axls	2032950L	Drive Shaft	36	59.5	40.5	486	
	2005.03-2010.11	MT	F	L	Saloon FWD BMA/CBAA	For Engine Code:CBAA,Steel Wheels	2033800L	Drive Shaft	36	59.5	40	487	
	2005.03-2010.11	MT	F	R	Saloon FWD BMA/CBAA	For Engine Code:CBAA,Steel Wheels	2033130L	Drive Shaft	36	59.5	40.5	794	
	2005.03-2010.11	MT	F	R	Saloon FWD BMA/CBAA	Date To:2007.03.For PR code:F4E/FSF/FBL.For 18axls	2033130L	Drive Shaft	36	59.5	40.5	794	
	2005.03-2010.11	MT	F	R	Saloon FWD BMA/CBAA		2033800L	Drive Shaft	36	59.5	40	487	
	2005.03-2010.11	MT	F	R	Saloon FWD BMA/CBAA	Date From:2008.03.For PR code:F4E/FSF/FBL	2611470L	Drive Shaft	36	59.5	40.5	795	
	2010.08-2014.12	6MT	F	L	Saloon FWD CFFA		2032950L	Drive Shaft	36	59.5	40.5	486	
	2010.08-2014.12	6MT	F	R	Saloon FWD CFFA		2033130L	Drive Shaft	36	59.5	40.5	794	
	2010.08-2014.12	AT	F	R	Saloon FWD CFFA		2540110L	Drive Shaft	36	59.5	40.5	760	
	2010.08-2014.12	MT	F	L	Saloon FWD CFFA		2033800L	Drive Shaft	36	59.5	40	487	
2.0 (103 kw)	2005.03-2008.05	6MT	F	L	Saloon 4WD BMP		2032950L	Drive Shaft	36	59.5	40.5	486	
	2005.03-2008.05	6MT	F	R	Saloon 4WD BMP		2032660L	Drive Shaft	36	59.5	40.5	601	
	2005.03-2008.05	MT	F	L	Saloon 4WD BMP		2033800L	Drive Shaft	36	59.5	40	487	
	2005.03-2009.05	AT	F	L	Saloon FWD BMP	Date From:2008.01.For PR code:F4E/FSF/FBL.For 18axls	2033810L	Drive Shaft	36	59.5	40	485	
	2005.03-2009.05	AT	F	L	Saloon FWD BMP	Date To:2007.12.For PR code:F4E/FSF/FBL	2540130L	Drive Shaft	36	59.5	40.5	482	
	2005.03-2009.05	AT	F	R	Saloon FWD BMP	Date To:2007.12.For PR code:F4E/FSF/FBL	2540110L	Drive Shaft	36	59.5	40.5	760	
	2005.03-2009.05	MT	F	L	Saloon FWD BMP	For PR code:F5A/F4E/4G/F4J.For PR code:Q2/F4G/F4K/SF5FK	2032950L	Drive Shaft	36	59.5	40.5	486	
	2005.03-2009.05	MT	F	R	Saloon FWD BMP	For PR code:F5A/F4E/4G/F4J.For PR code:Q2/F4G/F4K/SF5FK	2033130L	Drive Shaft	36	59.5	40.5	794	
	2005.03-2009.05	MT	F	R	Saloon FWD BMP	Date From:2008.03.For PR code:F4E/FSF/FBL	2611470L	Drive Shaft	36	59.5	40.5	795	
	2005.03-2010.07	6MT	F	L	Saloon 4WD BKP/CBAB		2032950L	Drive Shaft	36	59.5	40.5	486	
	2005.03-2010.07	6MT	F	R	Saloon 4WD BKP/CBAB		2032660L	Drive Shaft	36	59.5	40.5	601	
	2005.03-2010.07	AT	F	L	Saloon FWD BKP/CBAB	Date From:2008.01.For PR code:F4E/FSF/FBL.For 18axls	2033810L	Drive Shaft	36	59.5	40	485	
	2005.03-2010.07	AT	F	L	Saloon FWD BKP/CBAB	For PR code:F5A/F4E/4G/F4J.For PR code:Q2/F4G/F4K/SF5FK	2540130L	Drive Shaft	36	59.5	40.5	482	
	2005.03-2010.07	AT	F	R	Saloon FWD BKP/CBAB	For PR code:F5A/F4E/4G/F4J.For PR code:Q2/F4G/F4K/SF5FK	2540110L	Drive Shaft	36	59.5	40.5	760	
	2005.03-2010.07	MT	F	L	Saloon FWD BKP/CBAB	For PR code:F5A/F4E/4G/F4J.For PR code:Q2/F4G/F4K/SF5FK	2032950L	Drive Shaft	36	59.5	40.5	486	
	2005.03-2010.07	MT	F	L	Saloon FWD BKP/CBAB	For no:CBAA,Wheels:Steel Wheels	2033800L	Drive Shaft	36	59.5	40	487	
	2005.03-2010.07	MT	F	R	Saloon FWD BKP/CBAB	For no:CBAA,Wheels:Steel Wheels	2033130L	Drive Shaft	36	59.5	40.5	794	
	2005.03-2010.07	MT	F	R	Saloon FWD BKP/CBAB	Date From:2008.03.For PR code:F4E/FSF/FBL	2611470L	Drive Shaft	36	59.5	40.5	795	
	2005.03-2010.07		F	L	Saloon FWD BKP/CBAB		2033800L	Drive Shaft	36	59.5	40	487	
	2010.08-2014.12	6DCT	F	L	Saloon FWD CFFB		2540130L	Drive Shaft	36	59.5	40.5	482	
	2010.08-2014.12	6DCT	F	R	Saloon FWD CFFB		2540110L	Drive Shaft	36	59.5	40.5	760	
	2010.08-2014.12	6MT	F	L	Saloon FWD CFFB		2032950L	Drive Shaft	36	59.5	40.5	486	
	2010.08-2014.12	6MT	F	R	Saloon FWD CFFB	For PR code:A8B/A8C/A8G/A9I	2033130L	Drive Shaft	36	59.5	40.5	794	
	2010.08-2014.12	MT	F	L	Saloon FWD CFFB		2033800L	Drive Shaft	36	59.5	40	487	
	2010.11-2014.12	6MT	F	L	Saloon 4WD CFFB		2032950L	Drive Shaft	36	59.5	40.5	486	
	2010.11-2014.12	6MT	F	R	Saloon 4WD CFFB		2032660L	Drive Shaft	36	59.5	40.5	601	
	2010.11-2014.12	MT	F	L	Saloon 4WD CFFB		2033800L	Drive Shaft	36	59.5	40	487	
2.0 (105 kw)	2008.06-2010.11	AT	F	L	Saloon FWD CBAC		2540130L	Drive Shaft	36	59.5	40.5	482	
	2008.06-2010.11	AT	F	R	Saloon FWD CBAC		2540110L	Drive Shaft	36	59.5	40.5	760	
	2008.06-2010.11	MT	F	L	Saloon FWD CBAC	Rims:With alloy rim	2032950L	Drive Shaft	36	59.5	40.5	486	
	2008.06-2010.11	MT	F	R	Saloon FWD CBAC	Rims:With alloy rim	2033130L	Drive Shaft	36	59.5	40.5	794	
2.0 (110 kw)	2005.03-2010.11	6MT	F	L	Saloon 4WD BLX/BLY/BVX		2032940L	Drive Shaft	36	59.5	40	517	
	2005.03-2010.11	6MT	F	R	Saloon 4WD BLX/BLY/BVX	For Engine Code:BLY/BVX	2610960L	Drive Shaft	36	59.5	40	800	
	2005.03-2010.11	AT	F	R	Saloon FWD BLR/BLY/BVY/BVZ		2610940L	Drive Shaft	36	26	59.5	40	884
	2005.03-2010.11	MT	F	L	Saloon FWD BLR/BLY/BVY/BVZ		2032940L	Drive Shaft	36	59.5	40	517	
	2005.03-2010.11	MT	F	R	Saloon FWD BLR/BLY/BVY/BVZ		2610420L	Drive Shaft	36	59.5	40	814	



YEAR	TRANSM.	F/R	L/R	BODY STYLE & DRIVE TYPE & ENGINE	REMARKS	GSP Ref.	PRODUCT	ABS	Technical Specifications					
									A	B	C	H	L	
VW Passat														
2.0 (110 kw)	2014.08-	6AT	F	L	Saloon 4WD CRLB/DFEA/DFGA/DTSA		2033810L	Drive Shaft		36		59.5	40	485
	2014.08-	6MT	F	L	Saloon 4WD CRLB/DFEA/DFGA/DTSA		2018960L	Drive Shaft		36		59.5	40	500
	2014.08-	6MT	F	R	Saloon 4WD CRLB/DFEA/DFGA/DTSA		2018890L	Drive Shaft		36		59.5	40	614
	2014.08-	6DCT	F	L	Saloon FWD CRLB/DBGA/DFGAD/SRA/DSRB/DTSA/DTSB		2033810L	Drive Shaft		36		59.5	40	485
	2014.08-	6DCT	F	R	Saloon FWD CRLB/DBGA/DFGAD/SRA/DSRB/DTSA/DTSB		2613450L	Drive Shaft		36		59.5	40	774
	2014.08-	6MT	F	L	Saloon FWD CRLB/DBGA/DFGAD/SRA/DSRB/DTSA/DTSB		2611000L	Drive Shaft		36		59.5	40.5	514
	2014.08-	6MT	F	R	Saloon FWD CRLB/DBGA/DFGAD/SRA/DSRB/DTSA/DTSB		2613410L	Drive Shaft		36		59.5	40.5	806
	2014.08-	7DCT	F	L	Saloon FWD CRLB/DBGA/DFGAD/SRA/DSRB/DTSA/DTSB		2023510L	Drive Shaft		36	37	59.5	40	570
	2014.08-	7DCT	F	R	Saloon FWD CRLB/DBGA/DFGAD/SRA/DSRB/DTSA/DTSB		2036130L	Drive Shaft		36	37	59.5	40	921
2.0 (120 kw)	2005.10-2009.05	AT	F	L	Saloon FWD BUZ		2540130L	Drive Shaft		36		59.5	40.5	482
	2005.10-2009.05	AT	F	R	Saloon FWD BUZ		2540110L	Drive Shaft		36		59.5	40.5	760
	2005.10-2009.05	MT	F	L	Saloon FWD BUZ		2033800L	Drive Shaft		36		59.5	40	487
2.0 (125 kw)	2006.02-2010.11	AT	F	L	Saloon FWD BMR/CBBB	Date From:2006.02;For Engine Code:BMR	2540130L	Drive Shaft		36		59.5	40.5	482
	2006.02-2010.11	AT	F	R	Saloon FWD BMR/CBBB		2540110L	Drive Shaft		36		59.5	40.5	760
	2006.02-2010.11	MT	F	L	Saloon FWD BMR/CBBB		2033800L	Drive Shaft		36		59.5	40	487
	2009.05-2010.11	6AT	F	L	Saloon 4WD CBBB		2033810L	Drive Shaft		36		59.5	40	485
	2009.05-2010.11	6AT	F	L	Saloon 4WD CBBB		2540130L	Drive Shaft		36		59.5	40.5	482
	2009.05-2010.11	MT	F	L	Saloon 4WD CBBB		2033800L	Drive Shaft		36		59.5	40	487
	2010.08-2014.12	6DCT	F	L	Saloon FWD CFGB/CLLA	Date To:2013.05	2540130L	Drive Shaft		36		59.5	40.5	482
	2010.08-2014.12	6DCT	F	R	Saloon FWD CFGB/CLLA	Date From:2013.06	2033540L	Drive Shaft		36		59.5	40	760
	2010.08-2014.12	6DCT	F	R	Saloon FWD CFGB/CLLA	Date To:2013.05	2540110L	Drive Shaft		36		59.5	40.5	760
	2010.08-2014.12	6MT	F	L	Saloon FWD CFGB/CLLA	Date To:2013.05	2033800L	Drive Shaft		36		59.5	40	487
	2010.08-2014.12	6MT	F	R	Saloon FWD CFGB/CLLA	Date From:2013.06	2033130L	Drive Shaft		36		59.5	40.5	794
	2010.11-2013.01	6AT/6MT	F	L	Saloon 4WD CFGB	For PR code:8AT	2033810L	Drive Shaft		36		59.5	40	485
	2010.11-2013.01	6DCT	F	L	Saloon 4WD CFGB	For PR code:A8B/A8C/A8G/A9I	2540130L	Drive Shaft		36		59.5	40.5	482
	2010.11-2013.01	6DCT	F	L	Saloon 4WD CFGB	For PR code:8AT	2540130L	Drive Shaft		36		59.5	40.5	482
	2010.11-2013.01	MT	F	L	Saloon 4WD CFGB		2033800L	Drive Shaft		36		59.5	40	487
2.0 (130 kw)	2012.12-2014.12	6DCT	F	R	Saloon FWD CFGC		2033540L	Drive Shaft		36		59.5	40	760
	2012.12-2014.12	6MT	F	L	Saloon FWD CFGC		2033800L	Drive Shaft		36		59.5	40	487
	2012.12-2014.12	6MT	F	R	Saloon FWD CFGC	Date From:2013.06	2033130L	Drive Shaft		36		59.5	40.5	794
	2013.01-2014.12	6AT	F	L	Saloon 4WD CFGC	For PR code:A8B/A8C/A8G/A9I	2540130L	Drive Shaft		36		59.5	40.5	482
	2013.01-2014.12	6DCT	F	L	Saloon 4WD CFGC	For PR code:8AT	2033810L	Drive Shaft		36		59.5	40	485
2.0 (135 kw)	2015.07-	6AT	F	L	Saloon FWD CUPA		2033810L	Drive Shaft		36		59.5	40	485
	2015.07-	6AT	F	R	Saloon FWD CUPA		2613450L	Drive Shaft		36		59.5	40	774
2.0 (140 kw)	2014.11-	6AT	F	L	Saloon 4WD DDAA/DFCA/DFHA		2033810L	Drive Shaft		36		59.5	40	485
	2014.11-	7DCT	F	L	Saloon 4WD DDAA/DFCA/DFHA		2023510L	Drive Shaft		36	37	59.5	40	570
	2014.11-	6DCT	F	L	Saloon FWD DDAA/DFCA/DFHA		2033810L	Drive Shaft		36		59.5	40	485
	2014.11-	6DCT	F	R	Saloon FWD DDAA/DFCA/DFHA		2613450L	Drive Shaft		36		59.5	40	774
	2014.11-	6MT	F	L	Saloon FWD DDAA/DFCA/DFHA		2611000L	Drive Shaft		36		59.5	40.5	514
	2014.11-	6MT	F	R	Saloon FWD DDAA/DFCA/DFHA		2613410L	Drive Shaft		36		59.5	40.5	806
	2014.11-	7DCT	F	L	Saloon FWD DDAA/DFCA/DFHA		2023510L	Drive Shaft		36	37	59.5	40	570
	2014.11-	7DCT	F	R	Saloon FWD DDAA/DFCA/DFHA		2036130L	Drive Shaft		36	37	59.5	40	921
2.0 (147 kw)	2005.07-2010.11	AT	F	R	Saloon FWD AXB/BPY/BWA/CWB/CBFA/CCTA/CCZA	Date To:2010.01;For PR code:0ES	2016530L	Drive Shaft		36		59.5	40.5	785
	2005.07-2010.11	AT	F	R	Saloon FWD AXB/BPY/BWA/CWB/CBFA/CCTA/CCZA		2610940L	Drive Shaft		36	26	59.5	40	884
	2005.07-2010.11	MT	F	L	Saloon FWD AXB/BPY/BWA/CWB/CBFA/CCTA/CCZA		2032950L	Drive Shaft		36		59.5	40.5	486
	2005.07-2010.11	MT	F	L	Saloon FWD AXB/BPY/BWA/CWB/CBFA/CCTA/CCZA		2033800L	Drive Shaft		36		59.5	40	487
	2005.07-2010.11	MT	F	R	Saloon FWD AXB/BPY/BWA/CWB/CBFA/CCTA/CCZA		2611470L	Drive Shaft		36		59.5	40.5	795
	2020.09-	7DCT	F	R	Saloon FWD DTUA		2036130L	Drive Shaft		36	37	59.5	40	921
2.0 (155 kw)	2010.11-2014.12	6DCT	F	R	Saloon FWD CCZB		2016530L	Drive Shaft		36		59.5	40.5	785
	2010.11-2014.12	AT	F	L	Saloon FWD CCZB		2033800L	Drive Shaft		36		59.5	40	487
2.0 (176 kw)	2014.08-	6AT	F	L	Saloon 4WD CUAA		2033810L	Drive Shaft		36		59.5	40	485
	2014.08-	7AT	F	L	Saloon 4WD CUAA		2023510L	Drive Shaft		36	37	59.5	40	570
	2014.08-	7AT	F	R	Saloon 4WD CUAA		2613470L	Drive Shaft		36	40	59.5	40	593
2.0 (200 kw)	2018.09-	7AT	F	R	Saloon 4WD DNUA		2018890L	Drive Shaft		36		59.5	40	614
2.0 (206 kw)	2014.08-	6AT	F	R	Saloon 4WD CJXA/DNFE		2018890L	Drive Shaft		36		59.5	40	614
3.2 (184 kw)	2005.09-2010.11	6AT	F	L	Saloon 4WD AXZ	Date From:2006.11	2032950L	Drive Shaft		36		59.5	40.5	486
	2005.09-2010.11	6AT	F	L	Saloon 4WD AXZ	Date To:2006.10	2540130L	Drive Shaft		36		59.5	40.5	482
	2005.09-2010.11	6AT	F	R	Saloon 4WD AXZ		2032660L	Drive Shaft		36		59.5	40.5	601
	2005.09-2010.11	AT	F	L	Saloon 4WD AXZ		2033800L	Drive Shaft		36		59.5	40	487
3.6 (220 kw)	2007.04-2010.11	AT	F	L	Saloon 4WD BWS		2033800L	Drive Shaft		36		59.5	40	487
	2011.01-2014.12		F	L	Saloon 4WD BWS		2033800L	Drive Shaft		36		59.5	40	487
Passat Alltrack														
1.4 (110 kw)	2015.05-	6MT	F	L	Estate 4WD CZEA		2018960L	Drive Shaft		36		59.5	40	500
1.8 (112 kw)	2012.01-2013.05	6MT	F	L	Estate FWD CDAB	For PR code:A8T	2032950L	Drive Shaft		36		59.5	40.5	486
	2012.01-2013.05	6MT	F	L	Estate FWD CDAB	For PR code:A8B/A8C/A8G/A9I	2611000L	Drive Shaft		36		59.5	40.5	514



 YEAR	TRANSM.	F/R	L/R	BODY STYLE & DRIVE TYPE & ENGINE	REMARKS	GSP Ref.	 PRODUCT ABS	Technical Specifications					
								A	B	C	H	L	
VW													
Passat Alltrack													
1.8 (112 kw)	2012.01-2013.05	6MT	F	R	Estate FWD CDAB	For PR code:A8B/A8C/A8G/A9I	2613410L	Drive Shaft	36	59.5	40.5	806	
1.8 (118 kw)	2012.01-2014.12	6MT	F	L	Estate FWD CDA A	For PR code:A8T	2032950L	Drive Shaft	36	59.5	40.5	486	
	2012.01-2014.12	6MT	F	L	Estate FWD CDA A	For PR code:A8B/A8C/A8G/A9I	2611000L	Drive Shaft	36	59.5	40.5	514	
	2012.01-2014.12	6MT	F	R	Estate FWD CDA A	For PR code:A8B/A8C/A8G/A9I	2613410L	Drive Shaft	36	59.5	40.5	806	
2.0 (103 kw)	2010.08-2014.12	6MT	F	L	Estate FWD CFFB		2032950L	Drive Shaft	36	59.5	40.5	486	
	2010.08-2014.12	6MT	F	R	Estate FWD CFFB	For PR code:A8B/A8C/A8G/A9I	2033130L	Drive Shaft	36	59.5	40.5	794	
	2010.11-2014.12	6MT	F	L	Estate 4WD CFFB		2032950L	Drive Shaft	36	59.5	40.5	486	
	2010.11-2014.12	6MT	F	R	Estate 4WD CFFB		2032660L	Drive Shaft	36	59.5	40.5	601	
	2010.11-2014.12	MT	F	L	Estate 4WD CFFB		2033800L	Drive Shaft	36	59.5	40	487	
2.0 (110 kw)	2015.05-2017.11	6MT	F	L	Estate 4WD CRLB/DFEA		2018960L	Drive Shaft	36	59.5	40	500	
	2015.05-2017.11	6MT	F	R	Estate 4WD CRLB/DFEA		2018890L	Drive Shaft	36	59.5	40	614	
2.0 (125 kw)	2010.11-2013.01	6AT	F	L	Estate 4WD CFGB	For PR code:8AT	2033810L	Drive Shaft	36	59.5	40	485	
	2010.11-2013.01	6AT	F	L	Estate 4WD CFGB	For PR code:A8B/A8C/A8G/A9I	2540130L	Drive Shaft	36	59.5	40.5	482	
2.0 (130 kw)	2013.01-2014.12	6AT	F	L	Estate 4WD CFGC	For PR code:8AT	2033810L	Drive Shaft	36	59.5	40	485	
	2013.01-2014.12	6AT	F	L	Estate 4WD CFGC	For PR code:A8B/A8C/A8G/A9I	2540130L	Drive Shaft	36	59.5	40.5	482	
2.0 (135 kw)	2015.07-	6AT	F	L	Estate 4WD CUPA		2033810L	Drive Shaft	36	59.5	40	485	
2.0 (140 kw)	2015.05-	6DCT	F	L	Estate 4WD DDAA/DFCA/DFHA		2033810L	Drive Shaft	36	59.5	40	485	
	2015.05-	7DCT	F	L	Estate 4WD DDAA/DFCA/DFHA		2023510L	Drive Shaft	36	37	59.5	40	570
2.0 (155 kw)	2012.01-2014.12		F	L	Estate 4WD CCZB		2033800L	Drive Shaft	36	59.5	40	487	
2.0 (162 kw)	2015.07-	7AT	F	L	Estate 4WD CHHB		2023510L	Drive Shaft	36	37	59.5	40	570
	2015.07-	AT	F	L	Estate 4WD CHHB	Date From:2016.01	2012650L	Drive Shaft	36	37	59.5	40	558
	2015.07-	AT	F	R	Estate 4WD CHHB	Date From:2016.01	2613470L	Drive Shaft	36	40	59.5	40	593
2.0 (176 kw)	2015.05-	7AT	F	L	Estate 4WD CUAA		2023510L	Drive Shaft	36	37	59.5	40	570
	2015.05-	7AT	F	R	Estate 4WD CUAA		2613470L	Drive Shaft	36	40	59.5	40	593
2.0 (200 kw)	2018.08-	7AT	F	R	Estate 4WD DNUA		2018890L	Drive Shaft	36	59.5	40	614	
2.0 (206 kw)	2018.11-	6AT	F	R	Estate 4WD CJXA/DNFE		2018890L	Drive Shaft	36	59.5	40	614	
Passat CC													
1.4 (118 kw)	2011.01-2011.12	6MT	F	L	Coupe FWD CKMA		2612010L	Drive Shaft	36	59.5	40	536	
	2011.01-2011.12	6MT	F	R	Coupe FWD CKMA		2610960L	Drive Shaft	36	59.5	40	800	
	2011.01-2011.12	7DCT	F	L	Coupe FWD CKMA		2612810L	Drive Shaft	36	59.5	40.5	525	
	2011.01-2011.12	7DCT	F	R	Coupe FWD CKMA		2016530L	Drive Shaft	36	59.5	40.5	785	
1.8 (112 kw)	2008.11-2011.12	6MT	F	L	Coupe FWD CDAB/CGYA	For PR code:EL/Ther. code:NG285/For Engine Code:CM9E/For Engine Code:CDKX	2611000L	Drive Shaft	36	59.5	40.5	514	
	2008.11-2011.12	6MT	F	R	Coupe FWD CDAB/CGYA	For PR code:EL/Ther. code:NG285/For Engine Code:CM9E/For Engine Code:CDKX	2613410L	Drive Shaft	36	59.5	40.5	806	
	2008.11-2011.12	7DCT	F	R	Coupe FWD CDAB/CGYA		2033130L	Drive Shaft	36	59.5	40.5	794	
1.8 (118 kw)	2008.05-2011.12	6MT	F	L	Coupe FWD BZB/CDA A	For Engine Code:82B/For PR code:EL/Ther. code:NG285/For Engine Code:CDKX	2611000L	Drive Shaft	36	59.5	40.5	514	
	2008.05-2011.12	6MT	F	R	Coupe FWD BZB/CDA A	For Engine Code:82B/For PR code:EL/Ther. code:NG285/For Engine Code:CDKX	2613410L	Drive Shaft	36	59.5	40.5	806	
	2008.05-2011.12	7AT	F	L	Coupe FWD BZB/CDA A		2033800L	Drive Shaft	36	59.5	40	487	
	2008.05-2011.12	7DCT	F	R	Coupe FWD BZB/CDA A		2033130L	Drive Shaft	36	59.5	40.5	794	
	2008.05-2011.12	AT	F	R	Coupe FWD BZB/CDA A		2610940L	Drive Shaft	36	26	59.5	40	884
2.0 (100 kw)	2008.05-2011.12	6DCT	F	L	Coupe FWD CBAA/CFFA		2540130L	Drive Shaft	36	59.5	40.5	482	
	2008.05-2011.12	6DCT	F	R	Coupe FWD CBAA/CFFA		2540110L	Drive Shaft	36	59.5	40.5	760	
	2008.05-2011.12	6MT	F	L	Coupe FWD CBAA/CFFA		2032950L	Drive Shaft	36	59.5	40.5	486	
	2008.05-2011.12	MT	F	L	Coupe FWD CBAA/CFFA		2033800L	Drive Shaft	36	59.5	40	487	
	2008.05-2011.12	MT/6MT	F	R	Coupe FWD CBAA/CFFA		2033130L	Drive Shaft	36	59.5	40.5	794	
2.0 (103 kw)	2008.03-2011.12	6DCT	F	L	Coupe FWD CBAB/CFFB		2540130L	Drive Shaft	36	59.5	40.5	482	
	2008.03-2011.12	6DCT	F	R	Coupe FWD CBAB/CFFB		2540110L	Drive Shaft	36	59.5	40.5	760	
	2008.03-2011.12	6MT	F	L	Coupe FWD CBAB/CFFB		2032950L	Drive Shaft	36	59.5	40.5	486	
	2008.03-2011.12	6MT	F	R	Coupe FWD CBAB/CFFB		2033130L	Drive Shaft	36	59.5	40.5	794	
	2008.03-2011.12	MT	F	L	Coupe FWD CBAB/CFFB		2033800L	Drive Shaft	36	59.5	40	487	
	2008.05-2011.12	6MT	F	L	Coupe 4WD CBAB/CFFB		2032950L	Drive Shaft	36	59.5	40.5	486	
	2008.05-2011.12	6MT	F	R	Coupe 4WD CBAB/CFFB		2032660L	Drive Shaft	36	59.5	40.5	601	
	2008.05-2011.12	MT	F	L	Coupe 4WD CBAB/CFFB		2033800L	Drive Shaft	36	59.5	40	487	
2.0 (105 kw)	2009.05-2010.11	6DCT	F	L	Coupe FWD CBAC		2540130L	Drive Shaft	36	59.5	40.5	482	
	2009.05-2010.11	6DCT	F	R	Coupe FWD CBAC		2540110L	Drive Shaft	36	59.5	40.5	760	
	2009.05-2010.11	6MT	F	L	Coupe FWD CBAC		2032950L	Drive Shaft	36	59.5	40.5	486	
	2009.05-2010.11	MT/6MT	F	R	Coupe FWD CBAC		2033130L	Drive Shaft	36	59.5	40.5	794	
2.0 (120 kw)	2008.05-2011.05	MT	F	L	Coupe FWD CBBA		2033800L	Drive Shaft	36	59.5	40	487	
2.0 (125 kw)	2008.08-2011.12	6DCT	F	L	Coupe FWD CBBB/CFGB/CLLA		2540130L	Drive Shaft	36	59.5	40.5	482	
	2008.08-2011.12	6DCT	F	R	Coupe FWD CBBB/CFGB/CLLA		2540110L	Drive Shaft	36	59.5	40.5	760	
	2008.08-2011.12	6MT	F	L	Coupe FWD CBBB/CFGB/CLLA		2033800L	Drive Shaft	36	59.5	40	487	
	2009.11-2011.12	6AT	F	L	Coupe 4WD CBBB/CFGB		2033810L	Drive Shaft	36	59.5	40	485	
	2009.11-2011.12	6AT	F	L	Coupe 4WD CBBB/CFGB		2540130L	Drive Shaft	36	59.5	40.5	482	
	2009.11-2011.12	MT	F	L	Coupe 4WD CBBB/CFGB		2033800L	Drive Shaft	36	59.5	40	487	
2.0 (147 kw)	2008.05-2010.12	6DCT	F	R	Coupe FWD CAWB/CBFA/CCZA	Date: To:2010.02/For Engine Code:CBFA/CCZA	2016530L	Drive Shaft	36	59.5	40.5	785	
	2008.05-2010.12	6MT	F	L	Coupe FWD CAWB/CBFA/CCZA		2032950L	Drive Shaft	36	59.5	40.5	486	



	 YEAR	TRANSM.	F/R	L/R	BODY STYLE & DRIVE TYPE & ENGINE	REMARKS	GSP Ref.	 PRODUCT ABS	Technical Specifications										
									A	B	C	H	L						
VW																			
Passat CC																			
2.0 (147 kw)	2008.05-2010.12	6MT	F	R	Coupe FWD CAWB/CBFA/CCZA		2611470L	Drive Shaft		36		59.5	40.5	795					
	2008.05-2010.12	MT	F	L	Coupe FWD CAWB/CBFA/CCZA		2033800L	Drive Shaft		36		59.5	40	487					
2.0 (155 kw)	2010.11-2011.12	6MT	F	R	Coupe FWD CCZB		2611470L	Drive Shaft		36		59.5	40.5	795					
	2010.11-2011.12		F	L	Coupe FWD CCZB		2033800L	Drive Shaft		36		59.5	40	487					
3.6 (220 kw)	2008.02-2011.12	AT	F	L	Coupe 4WD BWS		2033800L	Drive Shaft		36		59.5	40	487					
Passat Estate/Variant																			
1.4 (90 kw)	2007.05-2010.11	AT	F	L	Estate FWD CAXA	Date From:2008.11	2612810L	Drive Shaft		36		59.5	40.5	525					
	2007.05-2010.11	AT	F	R	Estate FWD CAXA	Date From:2008.11	2016530L	Drive Shaft		36		59.5	40.5	785					
	2007.05-2010.11	MT	F	L	Estate FWD CAXA		2612010L	Drive Shaft		36		59.5	40	536					
	2007.05-2010.11	MT	F	R	Estate FWD CAXA		2610960L	Drive Shaft		36		59.5	40	800					
	2010.08-2014.12	6MT/7DCT	F	L	Combi Van FWD CAXA		2612010L	Drive Shaft		36		59.5	40	536					
	2010.08-2014.12	6MT/7DCT	F	R	Combi Van FWD CAXA		2610960L	Drive Shaft		36		59.5	40	800					
	2010.08-2014.12	6MT/7DCT	F	L	Estate FWD CAXA		2612010L	Drive Shaft		36		59.5	40	536					
	2010.08-2014.12	6MT/7DCT	F	R	Estate FWD CAXA		2610960L	Drive Shaft		36		59.5	40	800					
1.4 (92 kw)	2014.11-	7DCT	F	L	Estate FWD CZCA		2612010L	Drive Shaft		36		59.5	40	536					
1.4 (110 kw)	2009.01-2010.11	6MT	F	R	Estate FWD CDGA		2610960L	Drive Shaft		36		59.5	40	800					
	2009.01-2010.11	AT	F	L	Estate FWD CDGA		2612810L	Drive Shaft		36		59.5	40.5	525					
	2009.01-2010.11	AT	F	R	Estate FWD CDGA		2016530L	Drive Shaft		36		59.5	40.5	785					
	2009.01-2010.11	MT	F	L	Estate FWD CDGA		2612010L	Drive Shaft		36		59.5	40	536					
	2010.09-2014.12	6MT	F	L	Estate FWD CDGA		2612010L	Drive Shaft		36		59.5	40	536					
	2010.09-2014.12	6MT	F	R	Estate FWD CDGA		2610960L	Drive Shaft		36		59.5	40	800					
	2010.09-2014.12	7DCT	F	L	Estate FWD CDGA		2612810L	Drive Shaft		36		59.5	40.5	525					
	2010.09-2014.12	7DCT	F	R	Estate FWD CDGA		2016530L	Drive Shaft		36		59.5	40.5	785					
	2014.08-	6MT	F	L	Estate 4WD CZEA		2018960L	Drive Shaft		36		59.5	40	500					
	2014.08-	7DCT	F	R	Estate FWD CZDA/CZEA		2613410L	Drive Shaft		36		59.5	40.5	806					
1.4 (118 kw)	2010.11-2014.12	6MT	F	L	Estate FWD CKMA		2612010L	Drive Shaft		36		59.5	40	536					
	2010.11-2014.12	6MT	F	R	Estate FWD CKMA		2610960L	Drive Shaft		36		59.5	40	800					
	2010.11-2014.12	7DCT	F	L	Estate FWD CKMA		2612810L	Drive Shaft		36		59.5	40.5	525					
	2010.11-2014.12	7DCT	F	R	Estate FWD CKMA		2016530L	Drive Shaft		36		59.5	40.5	785					
	2012.11-2014.12	6MT	F	L	Estate FWD CTHD		2612010L	Drive Shaft		36		59.5	40	536					
	2012.11-2014.12	6MT	F	R	Estate FWD CTHD		2610960L	Drive Shaft		36		59.5	40	800					
	2012.11-2014.12	7DCT	F	L	Estate FWD CTHD		2612810L	Drive Shaft		36		59.5	40.5	525					
	2012.11-2014.12	7DCT	F	R	Estate FWD CTHD		2016530L	Drive Shaft		36		59.5	40.5	785					
1.6 (75 kw)	2005.08-2010.11	5MT	F	L	Estate FWD BSE/BSF		2033730L	Drive Shaft		36		59.5	40	517					
	2005.08-2010.11	5MT	F	R	Estate FWD BSE/BSF		2610420L	Drive Shaft		36		59.5	40	814					
	2005.08-2010.11	AT	F	R	Estate FWD BSE/BSF		2610940L	Drive Shaft		36	26	59.5	40	884					
1.6 (77 kw)	2009.08-2010.11	5MT	F	L	Estate FWD CAYC		2612820L	Drive Shaft		36		59.5	40	523					
	2009.08-2010.11	5MT	F	R	Estate FWD CAYC		2612830L	Drive Shaft		36		59.5	40	815					
	2009.08-2010.11	MT	F	L	Estate FWD CAYC		2032940L	Drive Shaft		36		59.5	40	517					
	2009.08-2010.11		F	R	Estate FWD CAYC		2610420L	Drive Shaft		36		59.5	40	814					
	2010.08-2014.12	6MT	F	L	Combi Van FWD CAYC		2612820L	Drive Shaft		36		59.5	40	523					
	2010.08-2014.12	6MT	F	R	Combi Van FWD CAYC		2612830L	Drive Shaft		36		59.5	40	815					
	2010.08-2014.12		F	R	Combi Van FWD CAYC		2610420L	Drive Shaft		36		59.5	40	814					
	2010.08-2014.12	6MT	F	L	Estate FWD CAYC		2612820L	Drive Shaft		36		59.5	40	523					
	2010.08-2014.12	6MT	F	R	Estate FWD CAYC		2612830L	Drive Shaft		36		59.5	40	815					
	2010.08-2014.12	7DCT	F	L	Estate FWD CAYC	Date To:2009.11	2611000L	Drive Shaft		36		59.5	40.5	514					
	2010.08-2014.12	7DCT	F	R	Estate FWD CAYC		2033130L	Drive Shaft		36		59.5	40.5	794					
	2010.08-2014.12	MT	F	L	Estate FWD CAYC		2032940L	Drive Shaft		36		59.5	40	517					
	2010.08-2014.12		F	R	Estate FWD CAYC		2610420L	Drive Shaft		36		59.5	40	814					
1.6 (85 kw)	2005.03-2008.06	MT	F	L	Estate FWD BLF		2612010L	Drive Shaft		36		59.5	40	536					
	2005.03-2008.06	MT	F	R	Estate FWD BLF		2610960L	Drive Shaft		36		59.5	40	800					
1.6 (88 kw)	2014.08-	6MT/7DCT	F	L	Estate FWD DCXA/DCZA		2612010L	Drive Shaft		36		59.5	40	536					
	2014.08-	7DCT	F	R	Estate FWD DCXA/DCZA		2612830L	Drive Shaft		36		59.5	40	815					
1.8 (112 kw)	2008.11-2010.11	AT	F	R	Estate FWD CDAB/CGYA		2033130L	Drive Shaft		36		59.5	40.5	794					
	2008.11-2010.11	AT/MT	F	L	Estate FWD CDAB/CGYA		2611000L	Drive Shaft		36		59.5	40.5	514					
	2008.11-2010.11	MT	F	L	Estate FWD CDAB/CGYA	For Engine Code:CDAB;For PR code:0EN;Transm code:M2350	2032950L	Drive Shaft		36		59.5	40.5	486					
	2008.11-2010.11	MT	F	R	Estate FWD CDAB/CGYA	For Engine Code:CDAB;For PR code:0EN;Transm code:M2350	2033130L	Drive Shaft		36		59.5	40.5	794					
	2008.11-2010.11	MT	F	R	Estate FWD CDAB/CGYA		2613410L	Drive Shaft		36		59.5	40.5	806					
	2011.02-2014.12	6MT	F	L	Estate FWD CDAB	For PR code:A8T	2032950L	Drive Shaft		36		59.5	40.5	486					
	2011.02-2014.12	6MT	F	L	Estate FWD CDAB	For PR code:A8B/A8C/A8G/A9I	2611000L	Drive Shaft		36		59.5	40.5	514					
	2011.02-2014.12	6MT	F	R	Estate FWD CDAB	For PR code:A8B/A8C/A8G/A9I	2613410L	Drive Shaft		36		59.5	40.5	806					
	2011.02-2014.12	7DCT	F	L	Estate FWD CDAB		2611000L	Drive Shaft		36		59.5	40.5	514					
1.8 (118 kw)	2007.05-2010.11	7AT	F	R	Estate FWD BZB/CDA	Date From:2009.01;For Engine Code:BZB/CDA	2033130L	Drive Shaft		36		59.5	40.5	794					
	2007.05-2010.11	MT	F	L	Estate FWD BZB/CDA	For Engine Code:CDA;For PR code:0EN	2032950L	Drive Shaft		36		59.5	40.5	486					
	2007.05-2010.11	MT	F	R	Estate FWD BZB/CDA	For Engine Code:CDA;For PR code:0EN	2033130L	Drive Shaft		36		59.5	40.5	794					



 YEAR	TRANSM.	F/R	L/R	BODY STYLE & DRIVE TYPE & ENGINE	REMARKS	GSP Ref.	 PRODUCT	 ABS	Technical Specifications				
									A	B	C	H	L
VW													
Passat Estate/Variant													
1.8 (118 kw)	2007.05-2010.11	MT	F	R	Estate FWD BZB/CDA	For Engine Code:BZB/CDA,For PR code:0EJ	2613410L	Drive Shaft	36	59.5	40.5	806	
	2007.05-2010.11	MT/7AT	F	L	Estate FWD BZB/CDA	For Engine Code:BZB/CDA,For PR code:0EJ,Date From:2009.01	2611000L	Drive Shaft	36	59.5	40.5	514	
	2010.08-2014.12	6MT	F	L	Combi Van FWD CDA	For PR code:A8T	2032950L	Drive Shaft	36	59.5	40.5	486	
	2010.08-2014.12	6MT	F	L	Combi Van FWD CDA	For PR code:A8B/A8C/A8G/A9I	2611000L	Drive Shaft	36	59.5	40.5	514	
	2010.08-2014.12	6MT	F	R	Combi Van FWD CDA	For PR code:A8B/A8C/A8G/A9I	2613410L	Drive Shaft	36	59.5	40.5	806	
	2010.08-2014.12	7DCT	F	L	Combi Van FWD CDA	For PR code:A8B/A8C/A8G/A9I	2611000L	Drive Shaft	36	59.5	40.5	514	
	2010.08-2014.12	6MT	F	L	Estate FWD CDA	For PR code:A8T	2032950L	Drive Shaft	36	59.5	40.5	486	
	2010.08-2014.12	6MT	F	L	Estate FWD CDA	For PR code:A8B/A8C/A8G/A9I	2611000L	Drive Shaft	36	59.5	40.5	514	
	2010.08-2014.12	6MT	F	R	Estate FWD CDA	For PR code:A8B/A8C/A8G/A9I	2613410L	Drive Shaft	36	59.5	40.5	806	
	2010.08-2014.12	7DCT	F	L	Estate FWD CDA		2611000L	Drive Shaft	36	59.5	40.5	514	
1.8 (132 kw)	2015.02-	6MT	F	L	Estate FWD CJA/CJSC		2611000L	Drive Shaft	36	59.5	40.5	514	
	2015.02-	6MT	F	R	Estate FWD CJA/CJSC		2613410L	Drive Shaft	36	59.5	40.5	806	
1.9 (77 kw)	2005.06-2010.11	AT	F	L	Estate FWD BKC/BLS/BXE		2540130L	Drive Shaft	36	59.5	40.5	482	
	2005.06-2010.11	AT	F	R	Estate FWD BKC/BLS/BXE		2540110L	Drive Shaft	36	59.5	40.5	760	
	2005.06-2010.11	MT	F	L	Estate FWD BKC/BLS/BXE		2032940L	Drive Shaft	36	59.5	40	517	
	2005.06-2010.11	MT	F	R	Estate FWD BKC/BLS/BXE		2610420L	Drive Shaft	36	59.5	40	814	
2.0 (81 kw)	2008.11-2010.11	5MT	F	L	Estate FWD CBDC	With steel rim;With alloy rim	2612820L	Drive Shaft	36	59.5	40	523	
	2008.11-2010.11	5MT	F	R	Estate FWD CBDC		2612830L	Drive Shaft	36	59.5	40	815	
	2008.11-2010.11	MT	F	L	Estate FWD CBDC		2032940L	Drive Shaft	36	59.5	40	517	
	2008.11-2010.11		F	R	Estate FWD CBDC	Date From:2009.11	2610420L	Drive Shaft	36	59.5	40	814	
2.0 (88 kw)	2005.11-2007.05	AT	F	L	Estate FWD BWV		2540130L	Drive Shaft	36	59.5	40.5	482	
	2005.11-2007.05	AT	F	R	Estate FWD BWV		2540110L	Drive Shaft	36	59.5	40.5	760	
	2005.11-2007.05	MT	F	L	Estate FWD BWV		2032950L	Drive Shaft	36	59.5	40.5	486	
	2005.11-2007.05	MT	F	R	Estate FWD BWV		2033130L	Drive Shaft	36	59.5	40.5	794	
	2005.11-2007.05		F	L	Estate FWD BWV		2033800L	Drive Shaft	36	59.5	40	487	
2.0 (90 kw)	2005.06-2006.05	AT	F	L	Estate FWD BVE		2540130L	Drive Shaft	36	59.5	40.5	482	
	2005.06-2006.05	AT	F	R	Estate FWD BVE		2540110L	Drive Shaft	36	59.5	40.5	760	
	2005.06-2006.05	MT	F	L	Estate FWD BVE		2032950L	Drive Shaft	36	59.5	40.5	486	
	2005.06-2006.05	MT	F	R	Estate FWD BVE		2033130L	Drive Shaft	36	59.5	40.5	794	
2.0 (100 kw)	2005.03-2009.11	AT	F	L	Estate FWD BMA/CBAA	Date From:2008.01,For PR code:F4E/SF/FBL,For tax	2033810L	Drive Shaft	36	59.5	40	485	
	2005.03-2009.11	AT	F	L	Estate FWD BMA/CBAA	For PR code:F5A/F4F/4G/F4J,For PR code:02F4G/F4K/F5G/F5K	2540130L	Drive Shaft	36	59.5	40.5	482	
	2005.03-2009.11	AT	F	R	Estate FWD BMA/CBAA	For PR code:F5A/F4F/4G/F4J,For PR code:02F4G/F4K/F5G/F5K	2540110L	Drive Shaft	36	59.5	40.5	760	
	2005.03-2009.11	MT	F	L	Estate FWD BMA/CBAA	For PR code:F5A/F4F/4G/F4J,For PR code:02F4G/F4K/F5G/F5K	2032950L	Drive Shaft	36	59.5	40.5	486	
	2005.03-2009.11	MT	F	L	Estate FWD BMA/CBAA		2033800L	Drive Shaft	36	59.5	40	487	
	2005.03-2009.11	MT	F	R	Estate FWD BMA/CBAA	For PR code:F5A/F4F/4G/F4J,For PR code:02F4G/F4K/F5G/F5K	2033130L	Drive Shaft	36	59.5	40.5	794	
	2005.03-2009.11	MT	F	R	Estate FWD BMA/CBAA	Date From:2008.03,For PR code:F4E/SF/FBL,For tax	2611470L	Drive Shaft	36	59.5	40.5	795	
	2010.08-2014.12	6MT	F	L	Estate FWD CFFA		2032950L	Drive Shaft	36	59.5	40.5	486	
	2010.08-2014.12	6MT	F	R	Estate FWD CFFA		2033130L	Drive Shaft	36	59.5	40.5	794	
2.0 (103 kw)	2005.03-2010.11	6MT	F	L	Estate 4WD BKP/CBAB		2032950L	Drive Shaft	36	59.5	40.5	486	
	2005.03-2010.11	6MT	F	R	Estate 4WD BKP/CBAB		2032660L	Drive Shaft	36	59.5	40.5	601	
	2005.03-2010.11	AT	F	L	Estate FWD BKP/CBAB	Date From:2008.01,For PR code:F4E/SF/FBL,For tax	2033810L	Drive Shaft	36	59.5	40	485	
	2005.03-2010.11	AT	F	L	Estate FWD BKP/CBAB	For PR code:F5A/F4F/4G/F4J,For PR code:02F4G/F4K/F5G/F5K	2540130L	Drive Shaft	36	59.5	40.5	482	
	2005.03-2010.11	AT	F	R	Estate FWD BKP/CBAB	For PR code:F5A/F4F/4G/F4J,For PR code:02F4G/F4K/F5G/F5K	2540110L	Drive Shaft	36	59.5	40.5	760	
	2005.03-2010.11	MT	F	L	Estate FWD BKP/CBAB	For PR code:F5A/F4F/4G/F4J,For PR code:02F4G/F4K/F5G/F5K	2032950L	Drive Shaft	36	59.5	40.5	486	
	2005.03-2010.11	MT	F	L	Estate FWD BKP/CBAB	For no:CBAA,Wheels:Steel Wheels	2033800L	Drive Shaft	36	59.5	40	487	
	2005.03-2010.11	MT	F	L	Estate FWD BKP/CBAB		2033800L	Drive Shaft	36	59.5	40	487	
	2005.03-2010.11	MT	F	R	Estate FWD BKP/CBAB		2033130L	Drive Shaft	36	59.5	40.5	794	
	2005.03-2010.11	MT	F	R	Estate FWD BKP/CBAB	Date From:2008.03,For PR code:F4E/SF/FBL,For tax	2611470L	Drive Shaft	36	59.5	40.5	795	
	2005.08-2008.05	6MT	F	L	Estate 4WD BMP		2032950L	Drive Shaft	36	59.5	40.5	486	
	2005.08-2008.05	6MT	F	R	Estate 4WD BMP		2032660L	Drive Shaft	36	59.5	40.5	601	
	2005.08-2008.05	MT	F	L	Estate 4WD BMP		2033800L	Drive Shaft	36	59.5	40	487	
	2005.08-2008.05	AT	F	L	Estate FWD BMP	For PR code:F5A/F4F/4G/F4J,For PR code:02F4G/F4K/F5G/F5K	2033810L	Drive Shaft	36	59.5	40	485	
	2005.08-2008.05	AT	F	L	Estate FWD BMP	For PR code:F5A/F4F/4G/F4J,For PR code:02F4G/F4K/F5G/F5K	2540130L	Drive Shaft	36	59.5	40.5	482	
	2005.08-2008.05	AT	F	R	Estate FWD BMP	For PR code:F5A/F4F/4G/F4J,For PR code:02F4G/F4K/F5G/F5K	2540110L	Drive Shaft	36	59.5	40.5	760	
	2005.08-2008.05	MT	F	L	Estate FWD BMP	For PR code:F5A/F4F/4G/F4J,For PR code:02F4G/F4K/F5G/F5K	2032950L	Drive Shaft	36	59.5	40.5	486	
	2005.08-2008.05	MT	F	R	Estate FWD BMP	For PR code:F5A/F4F/4G/F4J,For PR code:02F4G/F4K/F5G/F5K	2033130L	Drive Shaft	36	59.5	40.5	794	
	2005.08-2008.05	MT	F	R	Estate FWD BMP	Date From:2008.03,For PR code:F4E/SF/FBL,For tax	2611470L	Drive Shaft	36	59.5	40.5	795	
	2010.08-2014.12	6DCT	F	L	Combi Van FWD CFFB		2540130L	Drive Shaft	36	59.5	40.5	482	
	2010.08-2014.12	6DCT	F	R	Combi Van FWD CFFB		2540110L	Drive Shaft	36	59.5	40.5	760	
	2010.08-2014.12	6MT	F	L	Combi Van FWD CFFB		2032950L	Drive Shaft	36	59.5	40.5	486	
	2010.08-2014.12	6MT	F	R	Combi Van FWD CFFB	For PR code:A8B/A8C/A8G/A9I	2033130L	Drive Shaft	36	59.5	40.5	794	
	2010.08-2014.12	6DCT	F	L	Estate FWD CFFB		2540130L	Drive Shaft	36	59.5	40.5	482	
	2010.08-2014.12	6DCT	F	R	Estate FWD CFFB		2540110L	Drive Shaft	36	59.5	40.5	760	
	2010.08-2014.12	6MT	F	L	Estate FWD CFFB		2032950L	Drive Shaft	36	59.5	40.5	486	
	2010.08-2014.12	6MT	F	R	Estate FWD CFFB	For PR code:A8B/A8C/A8G/A9I	2033130L	Drive Shaft	36	59.5	40.5	794	



 YEAR	TRANSM.	F/R	L/R	BODY STYLE & DRIVE TYPE & ENGINE	REMARKS	GSP Ref.	 PRODUCT	 ABS	Technical Specifications					
									A	B	C	H	L	
VW														
Passat Estate/Variant														
2.0 (103 kw)	2010.08-2014.12	MT	F	L	Estate FWD CFFB		2033800L	Drive Shaft		36		59.5	40	487
	2010.11-2014.12	6MT	F	L	Estate 4WD CFFB		2032950L	Drive Shaft		36		59.5	40.5	486
	2010.11-2014.12	6MT	F	R	Estate 4WD CFFB		2032660L	Drive Shaft		36		59.5	40.5	601
2.0 (105 kw)	2008.06-2010.11	AT	F	L	Estate FWD CBAC		2540130L	Drive Shaft		36		59.5	40.5	482
	2008.06-2010.11	AT	F	R	Estate FWD CBAC		2540110L	Drive Shaft		36		59.5	40.5	760
	2008.06-2010.11	MT	F	L	Estate FWD CBAC	Rims:With alloy rim	2032950L	Drive Shaft		36		59.5	40.5	486
	2008.06-2010.11	MT	F	L	Estate FWD CBAC	Rims:With steel rim	2033800L	Drive Shaft		36		59.5	40	487
	2008.06-2010.11	MT	F	L	Estate FWD CBAC		2033800L	Drive Shaft		36		59.5	40	487
	2008.06-2010.11	MT	F	R	Estate FWD CBAC		2033130L	Drive Shaft		36		59.5	40.5	794
2.0 (110 kw)	2005.03-2010.11	AT	F	R	Estate FWD BLR/BLY/BVY/BVZ		2610940L	Drive Shaft		36	26	59.5	40	884
	2005.03-2010.11	MT	F	L	Estate FWD BLR/BLY/BVY/BVZ		2032940L	Drive Shaft		36		59.5	40	517
	2005.03-2010.11	MT	F	R	Estate FWD BLR/BLY/BVY/BVZ		2610420L	Drive Shaft		36		59.5	40	814
	2005.09-2010.11	6MT	F	L	Estate 4WD BLX/BLY/BVX		2032940L	Drive Shaft		36		59.5	40	517
	2005.09-2010.11	6MT	F	R	Estate 4WD BLX/BLY/BVX	For Engine Code:BLY	2610420L	Drive Shaft		36		59.5	40	814
	2005.09-2010.11	6MT	F	R	Estate 4WD BLX/BLY/BVX	For Engine Code:BLY/BVX	2610960L	Drive Shaft		36		59.5	40	800
	2005.09-2010.11	AT	F	R	Estate 4WD BLX/BLY/BVX	Code:BLY	2610940L	Drive Shaft		36	26	59.5	40	884
	2014.08-	6MT	F	L	Estate 4WD CRLB/DFEA/DFGA/DTSA		2018960L	Drive Shaft		36		59.5	40	500
	2014.08-	6MT	F	R	Estate 4WD CRLB/DFEA/DFGA/DTSA		2018890L	Drive Shaft		36		59.5	40	614
	2014.08-	6DCT	F	L	Estate FWD CRLB/DBGA/DFGA/DSRA/DSRB/DTSA/DTSB		2033810L	Drive Shaft		36		59.5	40	485
	2014.08-	6DCT	F	R	Estate FWD CRLB/DBGA/DFGA/DSRA/DSRB/DTSA/DTSB		2613450L	Drive Shaft		36		59.5	40	774
	2014.08-	6MT	F	L	Estate FWD CRLB/DBGA/DFGA/DSRA/DSRB/DTSA/DTSB		2611000L	Drive Shaft		36		59.5	40.5	514
	2014.08-	6MT	F	R	Estate FWD CRLB/DBGA/DFGA/DSRA/DSRB/DTSA/DTSB		2613410L	Drive Shaft		36		59.5	40.5	806
	2014.08-	7DCT	F	L	Estate FWD CRLB/DBGA/DFGA/DSRA/DSRB/DTSA/DTSB		2023510L	Drive Shaft		36	37	59.5	40	570
	2014.08-	7DCT	F	R	Estate FWD CRLB/DBGA/DFGA/DSRA/DSRB/DTSA/DTSB		2036130L	Drive Shaft		36	37	59.5	40	921
2.0 (120 kw)	2005.10-2009.05	AT	F	L	Estate FWD BUZ		2540130L	Drive Shaft		36		59.5	40.5	482
	2005.10-2009.05	AT	F	R	Estate FWD BUZ		2540110L	Drive Shaft		36		59.5	40.5	760
	2005.10-2009.05	MT	F	L	Estate FWD BUZ		2033800L	Drive Shaft		36		59.5	40	487
2.0 (125 kw)	2006.02-2010.11	AT	F	R	Estate FWD BMR/CBBB		2540110L	Drive Shaft		36		59.5	40.5	760
	2006.02-2010.11	MT	F	L	Estate FWD BMR/CBBB		2033800L	Drive Shaft		36		59.5	40	487
	2006.02-2010.11	MT	F	R	Estate FWD BMR/CBBB		2033130L	Drive Shaft		36		59.5	40.5	794
	2009.11-2010.11	6AT	F	L	Estate 4WD CBBB		2033810L	Drive Shaft		36		59.5	40	485
	2009.11-2010.11	6AT	F	L	Estate 4WD CBBB		2540130L	Drive Shaft		36		59.5	40.5	482
	2010.08-2013.01	6DCT	F	L	Estate 4WD CFGB	For PR code:8AT	2033810L	Drive Shaft		36		59.5	40	485
	2010.08-2013.01	6DCT	F	L	Estate 4WD CFGB	For PR code:A8B/A8C/A8G/A9I	2540130L	Drive Shaft		36		59.5	40.5	482
	2010.08-2013.01	MT/Semi-AT	F	L	Estate 4WD CFGB		2033800L	Drive Shaft		36		59.5	40	487
	2010.08-2014.12	6DCT	F	L	Combi Van FWD CFGB/CLLA	Date To:2013.05	2540130L	Drive Shaft		36		59.5	40.5	482
	2010.08-2014.12	6DCT	F	R	Combi Van FWD CFGB/CLLA	Date From:2013.06	2033540L	Drive Shaft		36		59.5	40	760
	2010.08-2014.12	6DCT	F	R	Combi Van FWD CFGB/CLLA	Date To:2013.05	2540110L	Drive Shaft		36		59.5	40.5	760
	2010.08-2014.12	6MT	F	L	Combi Van FWD CFGB/CLLA	Date To:2013.05	2033800L	Drive Shaft		36		59.5	40	487
	2010.08-2014.12	6MT	F	R	Combi Van FWD CFGB/CLLA		2033130L	Drive Shaft		36		59.5	40.5	794
	2010.08-2014.12	6DCT	F	L	Estate FWD CFGB/CLLA	Date To:2013.05	2540130L	Drive Shaft		36		59.5	40.5	482
	2010.08-2014.12	6DCT	F	R	Estate FWD CFGB/CLLA	Date From:2013.06	2033540L	Drive Shaft		36		59.5	40	760
	2010.08-2014.12	6DCT	F	R	Estate FWD CFGB/CLLA	Date To:2013.05	2540110L	Drive Shaft		36		59.5	40.5	760
	2010.08-2014.12	6MT	F	L	Estate FWD CFGB/CLLA	Date To:2013.05	2033800L	Drive Shaft		36		59.5	40	487
	2010.08-2014.12	6MT	F	R	Estate FWD CFGB/CLLA	Date From:2013.06	2033130L	Drive Shaft		36		59.5	40.5	794
2.0 (130 kw)	2012.12-2014.12	6DCT	F	R	Estate FWD CFGC		2033540L	Drive Shaft		36		59.5	40	760
	2012.12-2014.12	6MT	F	L	Estate FWD CFGC		2033800L	Drive Shaft		36		59.5	40	487
	2012.12-2014.12	6MT	F	R	Estate FWD CFGC	Date From:2013.06	2033130L	Drive Shaft		36		59.5	40.5	794
	2013.01-2014.12	6AT	F	L	Estate 4WD CFGC	For PR code:A8B/A8C/A8G/A9I	2540130L	Drive Shaft		36		59.5	40.5	482
	2013.01-2014.12	6DCT	F	L	Estate 4WD CFGC	For PR code:8AT	2033810L	Drive Shaft		36		59.5	40	485
2.0 (135 kw)	2015.07-	6AT	F	L	Estate FWD CUPA		2033810L	Drive Shaft		36		59.5	40	485
	2015.07-	6AT	F	R	Estate FWD CUPA		2613450L	Drive Shaft		36		59.5	40	774
2.0 (140 kw)	2014.11-	6AT	F	L	Estate 4WD DDAA/DFCA/DFHA		2033810L	Drive Shaft		36		59.5	40	485
	2014.11-	7DCT	F	L	Estate 4WD DDAA/DFCA/DFHA		2023510L	Drive Shaft		36	37	59.5	40	570
	2014.11-	6DCT	F	L	Estate FWD DDAA/DFCA/DFHA		2033810L	Drive Shaft		36		59.5	40	485
	2014.11-	6DCT	F	R	Estate FWD DDAA/DFCA/DFHA		2613450L	Drive Shaft		36		59.5	40	774
	2014.11-	6MT	F	L	Estate FWD DDAA/DFCA/DFHA		2611000L	Drive Shaft		36		59.5	40.5	514
	2014.11-	6MT	F	R	Estate FWD DDAA/DFCA/DFHA		2613410L	Drive Shaft		36		59.5	40.5	806
	2014.11-	7DCT	F	L	Estate FWD DDAA/DFCA/DFHA		2023510L	Drive Shaft		36	37	59.5	40	570
	2014.11-	7DCT	F	R	Estate FWD DDAA/DFCA/DFHA		2036130L	Drive Shaft		36	37	59.5	40	921
2.0 (147 kw)	2005.07-2010.12	AT	F	R	Estate FWD AXB/BPY/BWA/CAWB/CBFA/CCTA/CCZA	Date To:2010.01;For PR code:0ES	2016530L	Drive Shaft		36		59.5	40.5	785
	2005.07-2010.12	AT	F	R	Estate FWD AXB/BPY/BWA/CAWB/CBFA/CCTA/CCZA		2610940L	Drive Shaft		36	26	59.5	40	884
	2005.07-2010.12	MT	F	L	Estate FWD AXB/BPY/BWA/CAWB/CBFA/CCTA/CCZA		2032950L	Drive Shaft		36		59.5	40.5	486
	2005.07-2010.12	MT	F	L	Estate FWD AXB/BPY/BWA/CAWB/CBFA/CCTA/CCZA		2033800L	Drive Shaft		36		59.5	40	487
	2005.07-2010.12	MT	F	R	Estate FWD AXB/BPY/BWA/CAWB/CBFA/CCTA/CCZA		2611470L	Drive Shaft		36		59.5	40.5	795



 YEAR	TRANSM.	F/R	L/R	BODY STYLE & DRIVE TYPE & ENGINE	REMARKS	GSP Ref.	 PRODUCT	 ABS	Technical Specifications					
									A	B	C	H	L	
VW														
Passat Estate/Variant														
2.0 (147 kw)	2020.09-	7DCT	F	R	Estate FWD DTUA		2036130L	Drive Shaft		36	37	59.5	40	921
2.0 (155 kw)	2010.11-2014.12	6DCT	F	R	Combi Van FWD CCZB		2016530L	Drive Shaft		36		59.5	40.5	785
	2010.11-2015.12	6DCT	F	R	Estate FWD CCZB		2016530L	Drive Shaft		36		59.5	40.5	785
	2010.11-2015.12		F	L	Estate FWD CCZB		2033800L	Drive Shaft		36		59.5	40	487
2.0 (176 kw)	2014.08-	7AT	F	L	Estate 4WD CUAU		2023510L	Drive Shaft		36	37	59.5	40	570
	2014.08-	7AT	F	R	Estate 4WD CUAU		2613470L	Drive Shaft		36	40	59.5	40	593
2.0 (200 kw)	2018.09-	7AT	F	R	Estate 4WD DNUA		2018890L	Drive Shaft		36		59.5	40	614
2.0 (206 kw)	2014.08-	6AT	F	R	Estate 4WD CXXA/DNFE		2018890L	Drive Shaft		36		59.5	40	614
3.2 (184 kw)	2005.09-2010.11	6AT	F	L	Estate 4WD AXZ	Date From:2006.11	2032950L	Drive Shaft		36		59.5	40.5	486
	2005.09-2010.11	6AT	F	L	Estate 4WD AXZ	Date To:2006.10	2540130L	Drive Shaft		36		59.5	40.5	482
	2005.09-2010.11	6AT	F	R	Estate 4WD AXZ		2032660L	Drive Shaft		36		59.5	40.5	601
	2005.09-2010.11	AT	F	L	Estate 4WD AXZ		2033800L	Drive Shaft		36		59.5	40	487
3.6 (220 kw)	2007.04-2010.11	AT	F	L	Estate 4WD BWS		2033800L	Drive Shaft		36		59.5	40	487
	2011.01-2014.12	AT	F	L	Estate 4WD BWS		2033800L	Drive Shaft		36		59.5	40	487
Scirocco														
1.4 (90 kw)	2008.08-2014.05	6MT	F	L	Hatchback Van FWD CAXA		2612010L	Drive Shaft		36		59.5	40	536
	2008.08-2014.05	6MT	F	R	Hatchback Van FWD CAXA		2610960L	Drive Shaft		36		59.5	40	800
	2008.08-2017.11	7AT/6MT	F	L	Coupe FWD CAXA/CMSB		2612010L	Drive Shaft		36		59.5	40	536
	2008.08-2017.11	7AT/6MT	F	R	Coupe FWD CAXA/CMSB		2610960L	Drive Shaft		36		59.5	40	800
1.4 (92 kw)	2013.11-2017.11	6MT	F	L	Coupe FWD CXSB/CZCA		2612820L	Drive Shaft		36		59.5	40	523
	2013.11-2017.11	6MT	F	R	Coupe FWD CXSB/CZCA		2613070L	Drive Shaft		36		59.5	40	820
1.4 (110 kw)	2015.07-2017.11	7AT	F	L	Coupe FWD CZDA		2611000L	Drive Shaft		36		59.5	40.5	514
1.4 (118 kw)	2008.06-2014.05	6MT	F	L	Hatchback Van FWD CAVD		2612010L	Drive Shaft		36		59.5	40	536
	2008.06-2014.05	6MT/7DCT	F	R	Hatchback Van FWD CAVD		2610960L	Drive Shaft		36		59.5	40	800
	2008.06-2014.05	7DCT	F	L	Hatchback Van FWD CAVD		2612810L	Drive Shaft		36		59.5	40.5	525
	2008.06-2014.05	AT	F	L	Hatchback Van FWD CAVD		2016530L	Drive Shaft		36		59.5	40.5	785
	2008.06-2017.11	AT	F	L	Coupe FWD CAVD/CNWA/CTHD/CTKA		2612810L	Drive Shaft		36		59.5	40.5	525
	2008.06-2017.11	AT	F	R	Coupe FWD CAVD/CNWA/CTHD/CTKA		2016530L	Drive Shaft		36		59.5	40.5	785
	2008.06-2017.11	MT	F	L	Coupe FWD CAVD/CNWA/CTHD/CTKA		2612010L	Drive Shaft		36		59.5	40	536
	2008.06-2017.11	MT	F	R	Coupe FWD CAVD/CNWA/CTHD/CTKA		2610960L	Drive Shaft		36		59.5	40	800
2.0 (100 kw)	2010.11-2013.11	AT	F	L	Coupe FWD CFHB		2540130L	Drive Shaft		36		59.5	40.5	482
	2010.11-2013.11	AT	F	R	Coupe FWD CFHB		2540110L	Drive Shaft		36		59.5	40.5	760
	2010.11-2013.11	MT	F	L	Coupe FWD CFHB		2032950L	Drive Shaft		36		59.5	40.5	486
	2010.11-2013.11	MT	F	L	Coupe FWD CFHB		2033800L	Drive Shaft		36		59.5	40	487
	2010.11-2013.11	MT	F	R	Coupe FWD CFHB		2033130L	Drive Shaft		36		59.5	40.5	794
2.0 (103 kw)	2008.08-2014.05	AT	F	L	Coupe FWD CBDB/CFHC		2540130L	Drive Shaft		36		59.5	40.5	482
	2008.08-2014.05	AT	F	R	Coupe FWD CBDB/CFHC		2540110L	Drive Shaft		36		59.5	40.5	760
	2008.08-2014.05	MT	F	L	Coupe FWD CBDB/CFHC		2032950L	Drive Shaft		36		59.5	40.5	486
	2008.08-2014.05	MT	F	L	Coupe FWD CBDB/CFHC		2033800L	Drive Shaft		36		59.5	40	487
	2008.08-2014.05	MT	F	R	Coupe FWD CBDB/CFHC		2033130L	Drive Shaft		36		59.5	40.5	794
	2008.08-2014.05	AT	F	L	Hatchback Van FWD CBDB/CFHC		2540130L	Drive Shaft		36		59.5	40.5	482
	2008.08-2014.05	AT	F	R	Hatchback Van FWD CBDB/CFHC		2540110L	Drive Shaft		36		59.5	40.5	760
	2008.08-2014.05	MT	F	L	Hatchback Van FWD CBDB/CFHC		2032950L	Drive Shaft		36		59.5	40.5	486
2.0 (110 kw)	2014.05-2017.11	MT	F	L	Coupe FWD CUUB		2032950L	Drive Shaft		36		59.5	40.5	486
2.0 (125 kw)	2009.05-2014.05	AT	F	L	Coupe FWD CBBB/CFGB		2033810L	Drive Shaft		36		59.5	40	485
	2009.05-2014.05	AT	F	L	Coupe FWD CBBB/CFGB		2540130L	Drive Shaft		36		59.5	40.5	482
	2009.05-2014.05	AT	F	R	Coupe FWD CBBB/CFGB		2540110L	Drive Shaft		36		59.5	40.5	760
	2009.05-2014.05	MT	F	L	Coupe FWD CBBB/CFGB		2032950L	Drive Shaft		36		59.5	40.5	486
	2009.05-2014.05	MT	F	L	Coupe FWD CBBB/CFGB		2033800L	Drive Shaft		36		59.5	40	487
	2009.05-2014.05	MT	F	R	Coupe FWD CBBB/CFGB		2033130L	Drive Shaft		36		59.5	40.5	794
	2009.05-2014.05	MT	F	R	Coupe FWD CBBB/CFGB		2611470L	Drive Shaft		36		59.5	40.5	795
	2009.05-2014.05	AT	F	L	Hatchback Van FWD CBBB/CFGB		2033810L	Drive Shaft		36		59.5	40	485
	2009.05-2014.05	AT	F	L	Hatchback Van FWD CBBB/CFGB		2540130L	Drive Shaft		36		59.5	40.5	482
	2009.05-2014.05	AT	F	R	Hatchback Van FWD CBBB/CFGB		2540110L	Drive Shaft		36		59.5	40.5	760
	2009.05-2014.05	MT	F	L	Hatchback Van FWD CBBB/CFGB		2032950L	Drive Shaft		36		59.5	40.5	486
	2009.05-2014.05	MT	F	R	Hatchback Van FWD CBBB/CFGB		2033130L	Drive Shaft		36		59.5	40.5	794
	2009.05-2014.05	MT	F	R	Hatchback Van FWD CBBB/CFGB		2611470L	Drive Shaft		36		59.5	40.5	795
	2.0 (130 kw)	2013.01-2014.05	AT	F	L	Coupe FWD CFGC		2540130L	Drive Shaft		36		59.5	40.5
2013.01-2014.05		AT	F	R	Coupe FWD CFGC		2540110L	Drive Shaft		36		59.5	40.5	760
2013.01-2014.05		MT	F	L	Coupe FWD CFGC		2032950L	Drive Shaft		36		59.5	40.5	486
2013.01-2014.05		MT	F	L	Coupe FWD CFGC		2033800L	Drive Shaft		36		59.5	40	487
2013.01-2014.05		MT	F	R	Coupe FWD CFGC		2033130L	Drive Shaft		36		59.5	40.5	794
2.0 (132 kw)	2014.05-2017.11	6MT	F	R	Coupe FWD CULA		2611470L	Drive Shaft		36		59.5	40.5	795
2.0 (135 kw)	2014.05-2017.11	AT	F	L	Coupe FWD CUWA/CUXA		2033810L	Drive Shaft		36		59.5	40	485



		TRANSM.	F/R	L/R	BODY STYLE & DRIVE TYPE & ENGINE	REMARKS	GSP Ref.		PRODUCT	ABS	Technical Specifications				
											A	B	C	H	L
VW Scirocco															
2.0 (135 kw)	2014.05-2017.11	AT	F	L	Coupe FWD CUWA/CUXA		2540130L	Drive Shaft		36	59.5	40.5	482		
	2014.05-2017.11	AT	F	R	Coupe FWD CUWA/CUXA		2540110L	Drive Shaft		36	59.5	40.5	760		
	2014.05-2017.11	MT	F	L	Coupe FWD CUWA/CUXA		2032950L	Drive Shaft		36	59.5	40.5	486		
	2014.05-2017.11	MT	F	R	Coupe FWD CUWA/CUXA		2033130L	Drive Shaft		36	59.5	40.5	794		
	2014.05-2017.11	MT	F	R	Coupe FWD CUWA/CUXA		2611470L	Drive Shaft		36	59.5	40.5	795		
2.0 (147 kw)	2008.06-2009.11	6MT	F	R	Coupe FWD CAWB		2033130L	Drive Shaft		36	59.5	40.5	794		
	2008.06-2009.11	AT/MT	F	L	Coupe FWD CAWB		2032950L	Drive Shaft		36	59.5	40.5	486		
2.0 (155 kw)	2009.11-2014.05	AT	F	L	Hatchback Van FWD CCZB		2032950L	Drive Shaft		36	59.5	40.5	486		
	2009.11-2014.05	MT	F	R	Hatchback Van FWD CCZB		2611470L	Drive Shaft		36	59.5	40.5	795		
	2009.11-2017.11	AT/MT	F	L	Coupe FWD CCZB		2032950L	Drive Shaft		36	59.5	40.5	486		
	2009.11-2017.11	AT/MT	F	L	Coupe FWD CCZB		2033800L	Drive Shaft		36	59.5	40	487		
2.0 (162 kw)	2014.05-2017.11	MT/DCT	F	L	Coupe FWD CULC		2032950L	Drive Shaft		36	59.5	40.5	486		
2.0 (195 kw)	2009.11-2014.05	6MT	F	R	Coupe FWD CDLA		2033130L	Drive Shaft		36	59.5	40.5	794		
	2009.11-2014.05	6MT	F	R	Coupe FWD CDLA		2611470L	Drive Shaft		36	59.5	40.5	795		
2.0 (206 kw)	2014.05-2017.11	AT	F	L	Coupe FWD CDLK		2032950L	Drive Shaft		36	59.5	40.5	486		
Sharan															
1.4 (110 kw)	2010.05-2015.11	6MT	F	L	MPV FWD CAVA/CNWB/CTHA	Date To:2011.11	2032950L	Drive Shaft		36	59.5	40.5	486		
	2010.05-2015.11	6MT	F	R	MPV FWD CAVA/CNWB/CTHA	Date To:2011.11	2033130L	Drive Shaft		36	59.5	40.5	794		
	2015.05-	6AT/6MT	F	L	MPV FWD CZDA/DJKA		2032950L	Drive Shaft		36	59.5	40.5	486		
	2015.05-	6AT/6MT	F	R	MPV FWD CZDA/DJKA		2033130L	Drive Shaft		36	59.5	40.5	794		
2.0 (85 kw)	2011.05-2019.07	6MT	F	L	MPV FWD CFFE/CUVA/DFLD/DLTC		2032950L	Drive Shaft		36	59.5	40.5	486		
	2011.05-2019.07	6MT	F	R	MPV FWD CFFE/CUVA/DFLD/DLTC		2033130L	Drive Shaft		36	59.5	40.5	794		
2.0 (100 kw)	2010.05-2015.11	6DCT	F	R	MPV FWD CFFA		2033540L	Drive Shaft		36	59.5	40	760		
	2010.05-2015.11	6MT	F	L	MPV FWD CFFA		2032950L	Drive Shaft		36	59.5	40.5	486		
	2010.05-2015.11	6MT	F	R	MPV FWD CFFA		2033130L	Drive Shaft		36	59.5	40.5	794		
2.0 (103 kw)	2010.05-2015.11	6DCT	F	R	MPV FWD CFFB		2033540L	Drive Shaft		36	59.5	40	760		
	2010.05-2015.11	6MT	F	L	MPV FWD CFFB	Date To:2014.07	2032950L	Drive Shaft		36	59.5	40.5	486		
	2010.05-2015.11	6MT	F	R	MPV FWD CFFB	Date To:2011.11	2033130L	Drive Shaft		36	59.5	40.5	794		
2.0 (110 kw)	2015.05-2020.10	6DCT	F	R	MPV FWD CUVC/DFLA/DLTA		2033540L	Drive Shaft		36	59.5	40	760		
	2015.05-2020.10	6MT	F	L	MPV FWD CUVC/DFLA/DLTA		2032950L	Drive Shaft		36	59.5	40.5	486		
	2015.05-2020.10	6MT	F	R	MPV FWD CUVC/DFLA/DLTA		2033130L	Drive Shaft		36	59.5	40.5	794		
2.0 (125 kw)	2010.05-2013.01	6DCT	F	R	MPV FWD CFGB		2033540L	Drive Shaft		36	59.5	40	760		
2.0 (130 kw)	2013.01-	6DCT	F	R	MPV FWD CFGC/DLUB		2033540L	Drive Shaft		36	59.5	40	760		
2.0 (135 kw)	2015.05-	6DCT	F	R	MPV FWD CUWA/DFMA		2033540L	Drive Shaft		36	59.5	40	760		
2.0 (147 kw)	2010.12-2015.11	6AT	F	L	MPV FWD CCZA		2032950L	Drive Shaft		36	59.5	40.5	486		
2.0 (162 kw)	2015.05-	6AT	F	L	MPV FWD DEDA		2032950L	Drive Shaft		36	59.5	40.5	486		
T-Roc															
1.5 (110 kw)	2017.11-	6MT	F	L	SUV FWD DADA/DPCA/DXDB	For PR code:0EJ	2611000L	Drive Shaft		36	59.5	40.5	514		
1.6 (85 kw)	2018.03-2021.06	6MT	F	L	SUV FWD DGTE		2612820L	Drive Shaft		36	59.5	40	523		
	2018.03-2021.06	6MT	F	R	SUV FWD DGTE		2612830L	Drive Shaft		36	59.5	40	815		
2.0 (110 kw)	2017.09-	7DCT	F	L	SUV 4WD DFFA/DTTA/DTTC		2012650L	Drive Shaft		36	37	59.5	40	558	
	2018.03-	6DCT	F	L	SUV FWD DFFA/DTTA/DTTC	For Engine Code:DFFA	2033810L	Drive Shaft		36	59.5	40	485		
	2018.03-	6MT	F	R	SUV FWD DFFA/DTTA/DTTC		2033130L	Drive Shaft		36	59.5	40.5	794		
	2018.03-	7DCT	F	L	SUV FWD DFFA/DTTA/DTTC		2012650L	Drive Shaft		36	37	59.5	40	558	
2.0 (140 kw)	2017.07-	7AT	F	L	SUV 4WD CZPB/DKZA/DNNA	For Engine code:DNNA	2012650L	Drive Shaft		36	37	59.5	40	558	
Tiguan															
1.4 (90 kw)	2010.08-2018.07	6MT	F	L	SUV FWD CAXA		2032950L	Drive Shaft		36	59.5	40.5	486		
	2010.08-2018.07	6MT	F	R	SUV FWD CAXA		2611470L	Drive Shaft		36	59.5	40.5	795		
1.4 (92 kw)	2015.05-2018.07	6MT	F	L	SUV FWD CZDB		2032950L	Drive Shaft		36	59.5	40.5	486		
	2015.05-2018.07	6MT	F	R	SUV FWD CZDB		2611470L	Drive Shaft		36	59.5	40.5	795		
	2016.01-	6DCT	F	L	SUV FWD CZCA/CZDB		2611000L	Drive Shaft		36	59.5	40.5	514		
	2016.01-	6DCT	F	R	SUV FWD CZCA/CZDB		2033130L	Drive Shaft		36	59.5	40.5	794		
	2016.01-	6MT	F	L	SUV FWD CZCA/CZDB		2018960L	Drive Shaft		36	59.5	40	500		
	2016.01-	6MT	F	R	SUV FWD CZCA/CZDB		2018960L	Drive Shaft		36	59.5	40	500		
1.4 (110 kw)	2007.11-2018.07	6MT	F	L	SUV 4WD BWK/CAVA/CTHA		2612960L	Drive Shaft		36	40	59.5	40.5	501	
	2008.05-2018.07	6MT	F	L	SUV FWD CAVA/CTHA		2032950L	Drive Shaft		36	59.5	40.5	486		
	2008.05-2018.07	6MT	F	R	SUV FWD CAVA/CTHA		2611470L	Drive Shaft		36	59.5	40.5	795		
	2015.05-2018.07	6MT	F	L	SUV FWD CZDA		2032950L	Drive Shaft		36	59.5	40.5	486		
	2015.05-2018.07	6MT	F	R	SUV FWD CZDA		2611470L	Drive Shaft		36	59.5	40.5	795		
	2016.03-	6AT/6MT	F	L	SUV 4WD CZDA/CZEA		2018960L	Drive Shaft		36	59.5	40	500		
	2016.03-	6DCT	F	L	SUV FWD CZDA/CZEA/DJVA		2611000L	Drive Shaft		36	59.5	40.5	514		
	2016.03-	6DCT	F	R	SUV FWD CZDA/CZEA/DJVA	For Engine code:CZEA	2033130L	Drive Shaft		36	59.5	40.5	794		
	2016.03-	6MT	F	L	SUV FWD CZDA/CZEA/DJVA		2018960L	Drive Shaft		36	59.5	40	500		
1.4 (118 kw)	2011.05-2018.07	6MT	F	L	SUV 4WD CAVD/CTHD		2612960L	Drive Shaft		36	40	59.5	40.5	501	
	2011.05-2018.07	6MT	F	L	SUV FWD CAVD/CTHD		2032950L	Drive Shaft		36	59.5	40.5	486		
	2011.05-2018.07	6MT	F	R	SUV FWD CAVD/CTHD		2611470L	Drive Shaft		36	59.5	40.5	795		

 YEAR	TRANSM.	F/R	L/R	BODY STYLE & DRIVE TYPE & ENGINE	REMARKS	GSP Ref.	 PRODUCT	 ABS	Technical Specifications					
									A	B	C	H	L	
VW Tiguan														
1.5 (96 kw)	2018.07-	6MT	F	L	SUV FWD DACB/DPBE		2018960L	Drive Shaft		36		59.5	40	500
1.5 (110 kw)	2018.11-	6MT	F	L	SUV FWD DADA/DPCA		2018960L	Drive Shaft		36		59.5	40	500
1.6 (85 kw)	2016.05-2020.06	6MT	F	L	SUV FWD DGDB		2611000L	Drive Shaft		36		59.5	40.5	514
	2016.05-2020.06	6MT	F	R	SUV FWD DGDB		2613410L	Drive Shaft		36		59.5	40.5	806
2.0 (81 kw)	2010.05-2018.07	6MT	F	L	SUV FWD CFFD/CUVE		2032950L	Drive Shaft		36		59.5	40.5	486
	2010.05-2018.07	6MT	F	R	SUV FWD CFFD/CUVE		2611470L	Drive Shaft		36		59.5	40.5	795
	2016.08-2020.07	6MT	F	L	SUV FWD CYKC		2611000L	Drive Shaft		36		59.5	40.5	514
	2016.08-2020.07	6MT	F	R	SUV FWD CYKC		2613410L	Drive Shaft		36		59.5	40.5	806
2.0 (85 kw)	2016.05-2019.07	6MT	F	L	SUV FWD DFGC		2611000L	Drive Shaft		36		59.5	40.5	514
	2016.05-2019.07	6MT	F	R	SUV FWD DFGC		2613410L	Drive Shaft		36		59.5	40.5	806
2.0 (100 kw)	2007.11-2018.07	6MT	F	L	SUV 4WD CBAA/CFFA		2612960L	Drive Shaft		36	40	59.5	40.5	501
	2007.11-2018.07	7DCT	F	L	SUV 4WD CBAA/CFFA	Date To:2011.02,Date From:2012.08	2012650L	Drive Shaft		36	37	59.5	40	558
	2007.11-2018.07	7DCT	F	R	SUV 4WD CBAA/CFFA	Date To:2011.02,Date From:2012.08	2613470L	Drive Shaft		36	40	59.5	40	593
2.0 (103 kw)	2007.11-2018.07	6AT/7DCT	F	R	SUV 4WD CBAB/CFFB/CLJA		2613470L	Drive Shaft		36	40	59.5	40	593
	2007.11-2018.07	6MT	F	L	SUV 4WD CBAB/CFFB/CLJA		2612960L	Drive Shaft		36	40	59.5	40.5	501
	2007.11-2018.07	7DCT	F	L	SUV 4WD CBAB/CFFB/CLJA		2012650L	Drive Shaft		36	37	59.5	40	558
	2007.11-2018.07	6MT	F	L	SUV FWD CBAB/CFFB		2032950L	Drive Shaft		36		59.5	40.5	486
	2007.11-2018.07	6MT	F	L	SUV FWD CBAB/CFFB		2612960L	Drive Shaft		36	40	59.5	40.5	501
2.0 (110 kw)	2007.11-2018.07	6MT	F	R	SUV FWD CBAB/CFFB		2611470L	Drive Shaft		36		59.5	40.5	795
	2015.05-2018.07	6MT	F	R	SUV 4WD CUVC		2032660L	Drive Shaft		36		59.5	40.5	601
	2015.05-2018.07	7DCT	F	L	SUV 4WD CUVC		2012650L	Drive Shaft		36	37	59.5	40	558
	2015.05-2018.07	7DCT	F	R	SUV 4WD CUVC		2613470L	Drive Shaft		36	40	59.5	40	593
	2015.05-2018.07	MT	F	L	SUV 4WD CUVC		2032950L	Drive Shaft		36		59.5	40.5	486
	2015.05-2018.07	6MT	F	L	SUV FWD CUVC		2032950L	Drive Shaft		36		59.5	40.5	486
	2015.05-2018.07	6MT	F	R	SUV FWD CUVC		2033130L	Drive Shaft		36		59.5	40.5	794
	2015.05-2018.07	6MT	F	R	SUV FWD CUVC		2611470L	Drive Shaft		36		59.5	40.5	795
	2016.01-	6MT	F	L	SUV 4WD DBGCD/DFGA/DTSA/DTSB	Transm. Type:MQ350,For PR code:0EN	2018960L	Drive Shaft		36		59.5	40	500
	2016.01-	6MT	F	L	SUV 4WD DBGCD/DFGA/DTSA/DTSB	For PR code:0EU,Trans. code:MQ500	2036840L	Drive Shaft		36	40	59.5	40	514
	2016.01-	6MT	F	R	SUV 4WD DBGCD/DFGA/DTSA/DTSB	For PR code:0EU,Trans. code:MQ500	2036830L	Drive Shaft		36	40	59.5	40	609
	2016.01-	7DCT	F	L	SUV 4WD DBGCD/DFGA/DTSA/DTSB		20323510L	Drive Shaft		36	37	59.5	40	570
	2016.01-	6MT	F	L	SUV FWD DFGA/DTSA/DTSB		2611000L	Drive Shaft		36		59.5	40.5	514
	2016.01-	6MT	F	R	SUV FWD DFGA/DTSA/DTSB		2613410L	Drive Shaft		36		59.5	40.5	806
2016.01-	7DCT	F	L	SUV FWD DFGA/DTSA/DTSB		2023510L	Drive Shaft		36	37	59.5	40	570	
2016.01-	7DCT	F	R	SUV FWD DFGA/DTSA/DTSB		2036130L	Drive Shaft		36	37	59.5	40	921	
2.0 (120 kw)	2008.02-2009.08	6MT	F	L	SUV 4WD CBBA		2612960L	Drive Shaft		36	40	59.5	40.5	501
	2008.02-2009.08	AT	F	R	SUV 4WD CBBA		2613470L	Drive Shaft		36	40	59.5	40	593
2.0 (125 kw)	2008.01-2018.07	6MT	F	L	SUV 4WD CAWA/CCTB/CCZC		2612960L	Drive Shaft		36	40	59.5	40.5	501
	2008.01-2018.07	6MT	F	R	SUV 4WD CAWA/CCTB/CCZC		2032690L	Drive Shaft		36	40	59.5	40	596
	2008.01-2018.07	7DCT	F	L	SUV 4WD CAWA/CCTB/CCZC		2012650L	Drive Shaft		36	37	59.5	40	558
	2008.01-2018.07	7DCT	F	R	SUV 4WD CAWA/CCTB/CCZC		2613470L	Drive Shaft		36	40	59.5	40	593
	2008.02-2018.07	6MT	F	L	SUV 4WD CBBB/CFGB		2612960L	Drive Shaft		36	40	59.5	40.5	501
	2008.02-2018.07	AT	F	R	SUV 4WD CBBB/CFGB		2613470L	Drive Shaft		36	40	59.5	40	593
2.0 (130 kw)	2012.11-2018.07	6MT	F	L	SUV 4WD CFGC		2612960L	Drive Shaft		36	40	59.5	40.5	501
	2012.11-2018.07	7DCT	F	L	SUV 4WD CFGC		2012650L	Drive Shaft		36	37	59.5	40	558
	2012.11-2018.07	7DCT	F	R	SUV 4WD CFGC		2613470L	Drive Shaft		36	40	59.5	40	593
2.0 (132 kw)	2011.05-2018.07	6MT	F	L	SUV 4WD CCZD		2612960L	Drive Shaft		36	40	59.5	40.5	501
	2011.05-2018.07	6MT	F	R	SUV 4WD CCZD		2032690L	Drive Shaft		36	40	59.5	40	596
	2011.05-2018.07	7DCT	F	L	SUV 4WD CCZD		2012650L	Drive Shaft		36	37	59.5	40	558
	2011.05-2018.07	7DCT	F	R	SUV 4WD CCZD		2613470L	Drive Shaft		36	40	59.5	40	593
	2016.01-	6MT	F	L	SUV 4WD CZPA		2018960L	Drive Shaft		36		59.5	40	500
2016.01-	7DCT	F	R	SUV 4WD CZPA		2018890L	Drive Shaft		36		59.5	40	614	
2.0 (135 kw)	2015.05-2018.07	7AT	F	L	SUV 4WD CUWA		2012650L	Drive Shaft		36	37	59.5	40	558
	2015.05-2018.07	7AT	F	R	SUV 4WD CUWA		2613470L	Drive Shaft		36	40	59.5	40	593
2.0 (140 kw)	2016.01-2020.07	7AT	F	L	SUV 4WD DFHA		2023510L	Drive Shaft		36	37	59.5	40	570
	2018.09-	7AT	F	R	SUV 4WD DKZA/DNNA		2018890L	Drive Shaft		36		59.5	40	614
2.0 (147 kw)	2007.11-2018.07	6MT	F	L	SUV 4WD CAWB/CCTA/CCZA		2612960L	Drive Shaft		36	40	59.5	40.5	501
	2007.11-2018.07	6MT	F	R	SUV 4WD CAWB/CCTA/CCZA		2032690L	Drive Shaft		36	40	59.5	40	596
	2007.11-2018.07	7DCT	F	L	SUV 4WD CAWB/CCTA/CCZA		2012650L	Drive Shaft		36	37	59.5	40	558
	2007.11-2018.07	7DCT	F	R	SUV 4WD CAWB/CCTA/CCZA		2613470L	Drive Shaft		36	40	59.5	40	593
	2007.11-2018.07	6MT	F	R	SUV FWD CAWB/CCTA	For Engine Code:CCTA,for vehicles with start-stop function	2033130L	Drive Shaft		36		59.5	40.5	794
	2020.06-	7AT	F	L	SUV 4WD DTUA		2023510L	Drive Shaft		36	37	59.5	40	570
2.0 (155 kw)	2011.05-2018.07	6MT	F	L	SUV 4WD CCZB		2612960L	Drive Shaft		36	40	59.5	40.5	501
	2011.05-2018.07	6MT	F	R	SUV 4WD CCZB		2032690L	Drive Shaft		36	40	59.5	40	596
	2011.05-2018.07	7DCT	F	L	SUV 4WD CCZB		2012650L	Drive Shaft		36	37	59.5	40	558
	2011.05-2018.07	7DCT	F	R	SUV 4WD CCZB		2613470L	Drive Shaft		36	40	59.5	40	593

 YEAR	TRANSM.	F/R	L/R	BODY STYLE & DRIVE TYPE & ENGINE	REMARKS	GSP Ref.	 PRODUCT	 ABS	Technical Specifications					
									A	B	C	H	L	
VW Tiguan														
2.0 (162 kw)	2016.05-	7AT	F	L	SUV 4WD CHHB	For Model code:BT1	2023510L	Drive Shaft		36	37	59.5	40	570
2.0 (169 kw)	2018.09-2020.07	7AT	F	L	SUV 4WD DKTA		2023510L	Drive Shaft		36	37	59.5	40	570
2.0 (176 kw)	2016.05-2020.07	7AT	F	L	SUV 4WD CUAU		2023510L	Drive Shaft		36	37	59.5	40	570
2.0 (235 kw)	2020.11-	7AT	F	L	SUV 4WD DNFG		2023510L	Drive Shaft		36	37	59.5	40	570
Tiguan Allspace														
2.0 (110 kw)	2017.06-	6MT	F	L	SUV 4WD DBGC/DFGA/D TSA/DTSB		2036840L	Drive Shaft		36	40	59.5	40	514
	2017.06-	6MT	F	R	SUV 4WD DBGC/DFGA/D TSA/DTSB		2036830L	Drive Shaft		36	40	59.5	40	609
	2017.06-	6MT	F	L	SUV FWD DFGA/D TSA/DTSB		2611000L	Drive Shaft		36		59.5	40.5	514
	2017.06-	6MT	F	R	SUV FWD DFGA/D TSA/DTSB		2613410L	Drive Shaft		36		59.5	40.5	806
Touareg														
3.0 (150 kw)	2010.01-2018.03	8AT	F	L/R	SUV 4WD CASD/CJMA/CRCD/CVWA		2350850L	Drive Shaft		30		64.4	103.5	526
3.0 (155 kw)	2006.12-2010.05	6AT	F	L/R	SUV 4WD BUN/CASB		2350850L	Drive Shaft		30		64.4	103.5	526
	2006.12-2010.05	6AT	R	L/R	SUV 4WD BUN/CASB		2612360L	Drive Shaft		30		64	103.5	737
3.0 (165 kw)	2004.11-2010.05	6AT/6MT	F	L/R	SUV 4WD BKS/CATA		2350850L	Drive Shaft		30		64.4	103.5	526
	2004.11-2010.05	6AT/6MT	R	L/R	SUV 4WD BKS/CATA	For PR code:1Y1.With differential lock	2350860L	Drive Shaft		30		103.5	724	
	2004.11-2010.05	6AT/6MT	R	L/R	SUV 4WD BKS/CATA	For PR code:1Y0	2612360L	Drive Shaft		30		64	103.5	737
	2010.06-2012.05	8AT	F	L/R	SUV 4WD CATA		2350850L	Drive Shaft		30		64.4	103.5	526
3.0 (176 kw)	2007.11-2010.05	6AT/6MT	F	L/R	SUV 4WD CASA/CASC		2350850L	Drive Shaft		30		64.4	103.5	526
	2007.11-2010.05	6AT/6MT	R	L/R	SUV 4WD CASA/CASC		2612360L	Drive Shaft		30		64	103.5	737
	2010.01-2014.12	8AT	F	L/R	SUV 4WD CASA/CNRB		2350850L	Drive Shaft		30		64.4	103.5	526
3.0 (180 kw)	2011.05-2018.03	8AT	F	L/R	SUV 4WD CJGD/CRCA		2350850L	Drive Shaft		30		64.4	103.5	526
3.0 (193 kw)	2014.08-2018.03	AT	F	L/R	SUV 4WD CVVA		2350850L	Drive Shaft		30		64.4	103.5	526
3.0 (213 kw)	2010.08-2014.12	AT	F	L/R	SUV 4WD CJTA	Date From:2011.01	2350850L	Drive Shaft		30		64.4	103.5	526
3.0 (245 kw)	2010.04-2018.03	8AT	F	L/R	SUV 4WD CGEA/CGFA		2350850L	Drive Shaft		30		64.4	103.5	526
3.2 (162 kw)	2002.11-2006.11	AT/MT	F	L/R	SUV 4WD AZZ/BKJ/BMV/BMX/BRJ		2350850L	Drive Shaft		30		64.4	103.5	526
	2002.11-2006.11	AT/MT	R	L/R	SUV 4WD AZZ/BKJ/BMV/BMX/BRJ	with differential lock	2350860L	Drive Shaft		30		103.5	724	
	2002.11-2006.11	AT/MT	R	L/R	SUV 4WD AZZ/BKJ/BMV/BMX/BRJ	without differential lock	2612360L	Drive Shaft		30		64	103.5	737
3.2 (177 kw)	2004.11-2006.11	AT/MT	F	L/R	SUV 4WD BKJ/BMV/BMX/BRJ		2350850L	Drive Shaft		30		64.4	103.5	526
	2004.11-2006.11	AT/MT	R	L/R	SUV 4WD BKJ/BMV/BMX/BRJ	with differential lock	2350860L	Drive Shaft		30		103.5	724	
	2004.11-2006.11	AT/MT	R	L/R	SUV 4WD BKJ/BMV/BMX/BRJ	without differential lock	2612360L	Drive Shaft		30		64	103.5	737
3.6 (183 kw)	2010.08-2018.03	8AT	F	L/R	SUV 4WD CMTA		2350850L	Drive Shaft		30		64.4	103.5	526
3.6 (206 kw)	2005.10-2010.12	6AT/6MT	F	L/R	SUV 4WD BHK		2350850L	Drive Shaft		30		64.4	103.5	526
	2005.10-2010.12	6AT/6MT	R	L/R	SUV 4WD BHK		2612360L	Drive Shaft		30		64	103.5	737
	2010.04-2018.03	8AT	F	L/R	SUV 4WD CGRA		2350850L	Drive Shaft		30		64.4	103.5	526
4.2 (228 kw)	2002.12-2006.11	6AT	F	L/R	SUV 4WD AXQ		2350850L	Drive Shaft		30		64.4	103.5	526
	2002.12-2006.11	6AT	R	L/R	SUV 4WD AXQ		2612360L	Drive Shaft		30		64	103.5	737
4.2 (250 kw)	2010.01-2018.03	8AT	F	L/R	SUV 4WD CKDA		2350850L	Drive Shaft		30		64.4	103.5	526
4.2 (257 kw)	2006.06-2010.05	AT	F	L/R	SUV 4WD BAR		2350850L	Drive Shaft		30		64.4	103.5	526
	2006.06-2010.05	AT	R	L/R	SUV 4WD BAR	with differential lock	2350860L	Drive Shaft		30		103.5	724	
	2006.06-2010.05	AT	R	L/R	SUV 4WD BAR	without differential lock	2612360L	Drive Shaft		30		64	103.5	737
4.2 (265 kw)	2011.01-2018.03	8AT	F	L/R	SUV 4WD CGNA		2350850L	Drive Shaft		30		64.4	103.5	526
5.0 (230 kw)	2002.11-2010.05	6AT	R	L/R	SUV 4WD AYH/BLE/BWF		2612360L	Drive Shaft		30		64	103.5	737
5.0 (258 kw)	2007.08-2010.05	6AT	R	L/R	SUV 4WD CBWA		2350860L	Drive Shaft		30		103.5	724	
6.0 (331 kw)	2004.08-2010.05	6AT	F	L/R	SUV 4WD BJN/CFRA	Date From:2007.05	2350850L	Drive Shaft		30		64.4	103.5	526
	2004.08-2010.05	6AT	R	L/R	SUV 4WD BJN/CFRA		2612360L	Drive Shaft		30		64	103.5	737
Touran														
1.2 (77 kw)	2010.05-2015.05	6MT	F	L	MPV FWD CBZB		2612010L	Drive Shaft		36		59.5	40	536
	2010.05-2015.05	6MT	F	R	MPV FWD CBZB		2610960L	Drive Shaft		36		59.5	40	800
1.4 (103 kw)	2006.02-2010.05	AT	F	L	MPV FWD BMY/CAVC		2033800L	Drive Shaft		36		59.5	40	487
	2006.02-2010.05	AT	F	L	MPV FWD BMY/CAVC	For Engine Code:CAVC	2612810L	Drive Shaft		36		59.5	40.5	525
	2006.02-2010.05	AT	F	R	MPV FWD BMY/CAVC	For Engine Code:CAVC	2016530L	Drive Shaft		36		59.5	40.5	785
	2006.02-2010.05	MT	F	L	MPV FWD BMY/CAVC		2612010L	Drive Shaft		36		59.5	40	536
	2006.02-2010.05	MT	F	R	MPV FWD BMY/CAVC		2610960L	Drive Shaft		36		59.5	40	800
	2010.05-2015.05	6MT	F	L	MPV FWD CAVC/CTHC		2612010L	Drive Shaft		36		59.5	40	536
	2010.05-2015.05	6MT	F	R	MPV FWD CAVC/CTHC		2610960L	Drive Shaft		36		59.5	40	800
	2010.05-2015.05	7DCT	F	L	MPV FWD CAVC/CTHC		2612810L	Drive Shaft		36		59.5	40.5	525
	2010.05-2015.05	7DCT	F	R	MPV FWD CAVC/CTHC		2016530L	Drive Shaft		36		59.5	40.5	785
	2010.05-2015.05	AT	F	L	MPV FWD CAVC/CTHC		2033800L	Drive Shaft		36		59.5	40	487
1.4 (110 kw)	2009.05-2010.05	7DCT	F	R	MPV FWD CDGA		2016530L	Drive Shaft		36		59.5	40.5	785
	2009.05-2010.05	AT/7DCT	F	L	MPV FWD CDGA		2612810L	Drive Shaft		36		59.5	40.5	525
	2009.05-2010.05	MT	F	L	MPV FWD CDGA		2612010L	Drive Shaft		36		59.5	40	536
	2009.05-2010.05	MT	F	R	MPV FWD CDGA		2610960L	Drive Shaft		36		59.5	40	800
	2010.05-2015.05	6MT	F	L	MPV FWD CDGA		2612010L	Drive Shaft		36		59.5	40	536
	2010.05-2015.05	6MT	F	R	MPV FWD CDGA		2610960L	Drive Shaft		36		59.5	40	800
	2010.05-2015.05	7DCT	F	L	MPV FWD CDGA		2612810L	Drive Shaft		36		59.5	40.5	525

 YEAR	TRANSM.	F/R	L/R	BODY STYLE & DRIVE TYPE & ENGINE	REMARKS	GSP Ref.	 PRODUCT	 ABS	Technical Specifications				
									A	B	C	H	L
VW													
Touran													
1.4 (110 kw)	2010.05-2015.05	7DCT	F	R	MPV FWD CDGA		2016530L	Drive Shaft	36	59.5	40.5	785	
1.4 (125 kw)	2006.11-2010.05	7AT	F	L	MPV FWD BLG/CAVB		2612810L	Drive Shaft	36	59.5	40.5	525	
	2006.11-2010.05	7AT	F	R	MPV FWD BLG/CAVB		2016530L	Drive Shaft	36	59.5	40.5	785	
	2006.11-2010.05	AT	F	L	MPV FWD BLG/CAVB		2033800L	Drive Shaft	36	59.5	40	487	
	2010.05-2015.05	7AT	F	L	MPV FWD CAVB/CTHB		2612810L	Drive Shaft	36	59.5	40.5	525	
	2010.05-2015.05	7AT	F	R	MPV FWD CAVB/CTHB		2016530L	Drive Shaft	36	59.5	40.5	785	
1.5 (110 kw)	2018.11-	6MT	F	L	MPV FWD DADA/DPCA	For PR code:0ED	2018960L	Drive Shaft	36	59.5	40	500	
	2018.11-	6MT	F	R	MPV FWD DADA/DPCA	For PR code:0ED	2033130L	Drive Shaft	36	59.5	40.5	794	
1.6 (66 kw)	2010.05-2015.05	6MT	F	L	MPV FWD CAYB		2612820L	Drive Shaft	36	59.5	40	523	
	2010.05-2015.05	6MT	F	R	MPV FWD CAYB		2612830L	Drive Shaft	36	59.5	40	815	
	2010.05-2015.05	MT	F	L	MPV FWD CAYB		2032940L	Drive Shaft	36	59.5	40	517	
	2010.05-2015.05		F	R	MPV FWD CAYB		2610420L	Drive Shaft	36	59.5	40	814	
1.6 (75 kw)	2003.07-2010.05	5MT	F	L	MPV FWD BGU/BSE/BSF		2033730L	Drive Shaft	36	59.5	40	517	
	2003.07-2010.05	5MT	F	R	MPV FWD BGU/BSE/BSF		2610420L	Drive Shaft	36	59.5	40	814	
	2003.07-2010.05	AT	F	R	MPV FWD BGU/BSE/BSF		2610940L	Drive Shaft	36	26	59.5	40	884
	2003.07-2010.05	MT	F	L	MPV FWD BGU/BSE/BSF		2032940L	Drive Shaft	36	59.5	40	517	
	2006.11-2010.05	5MT	F	L	MPV FWD BSF		2033730L	Drive Shaft	36	59.5	40	517	
	2006.11-2010.05	5MT	F	R	MPV FWD BSF		2610420L	Drive Shaft	36	59.5	40	814	
	2006.11-2010.05	5MT	F	R	MPV FWD BSF		2610420L	Drive Shaft	36	59.5	40	814	
1.6 (77 kw)	2010.05-2015.05	6MT	F	L	MPV FWD CAYC		2612820L	Drive Shaft	36	59.5	40	523	
	2010.05-2015.05	6MT	F	R	MPV FWD CAYC		2612830L	Drive Shaft	36	59.5	40	815	
	2010.05-2015.05	7DCT	F	L	MPV FWD CAYC	Date to:2011.05	2611000L	Drive Shaft	36	59.5	40.5	514	
	2010.05-2015.05	7DCT	F	L	MPV FWD CAYC	Date from:2011.06	2612820L	Drive Shaft	36	59.5	40	523	
	2010.05-2015.05	7DCT	F	R	MPV FWD CAYC	Date to:2011.05	2033130L	Drive Shaft	36	59.5	40.5	794	
	2010.05-2015.05	DCT	F	L	MPV FWD CAYC	Date to:2011.06	2033800L	Drive Shaft	36	59.5	40	487	
	2010.05-2015.05	DCT	F	L	MPV FWD CAYC	Date to:2011.06	2033800L	Drive Shaft	36	59.5	40	487	
1.6 (81 kw)	2015.05-	6MT/7DCT	F	L	MPV FWD CRKB		2612010L	Drive Shaft	36	59.5	40	536	
	2015.05-	7DCT	F	R	MPV FWD CRKB		2612830L	Drive Shaft	36	59.5	40	815	
1.6 (85 kw)	2003.02-2007.01	MT	F	L	MPV FWD BAG/BLF/BLP		2032940L	Drive Shaft	36	59.5	40	517	
	2016.05-	6MT/7DCT	F	L	MPV FWD DGDA		2612010L	Drive Shaft	36	59.5	40	536	
	2016.05-	7DCT	F	R	MPV FWD DGDA		2612830L	Drive Shaft	36	59.5	40	815	
1.8 (132 kw)	2015.12-	7AT	F	R	MPV FWD CJSA		2613410L	Drive Shaft	36	59.5	40.5	806	
	2015.12-	MT	F	L	MPV FWD CJSA		2611000L	Drive Shaft	36	59.5	40.5	514	
1.9 (66 kw)	2004.11-2010.05	6MT	F	L	MPV FWD BRU/BXF/BXJ	Trans. code:MQ250,For PR code:0EJ,Date To:2009.10	2032940L	Drive Shaft	36	59.5	40	517	
	2004.11-2010.05	6MT	F	L	MPV FWD BRU/BXF/BXJ	Trans. code:MQ350,For PR code:0EN,Date From:2009.11	2032950L	Drive Shaft	36	59.5	40.5	486	
	2004.11-2010.05	6MT	F	L	MPV FWD BRU/BXF/BXJ	Trans. code:MQ250,For PR code:0EJ,Date From:2009.11	2612820L	Drive Shaft	36	59.5	40	523	
	2004.11-2010.05	6MT	F	R	MPV FWD BRU/BXF/BXJ	Trans. code:MQ350,For PR code:0EN,Date From:2009.11	2033130L	Drive Shaft	36	59.5	40.5	794	
	2004.11-2010.05	6MT	F	R	MPV FWD BRU/BXF/BXJ	Trans. code:MQ250,For PR code:0EJ,Date To:2009.10	2610420L	Drive Shaft	36	59.5	40	814	
	2004.11-2010.05	6MT	F	R	MPV FWD BRU/BXF/BXJ	Trans. code:MQ250,For PR code:0EJ,Date From:2009.11	2612830L	Drive Shaft	36	59.5	40	815	
1.9 (74 kw)	2003.02-2005.05	6MT	F	L	MPV FWD AVQ		2032940L	Drive Shaft	36	59.5	40	517	
	2003.02-2005.05	6MT	F	R	MPV FWD AVQ		2610420L	Drive Shaft	36	59.5	40	814	
1.9 (77 kw)	2003.08-2006.11	6MT	F	L	MPV Van FWD BKC/BXE		2032940L	Drive Shaft	36	59.5	40	517	
	2003.08-2006.11	6MT	F	R	MPV Van FWD BKC/BXE		2610420L	Drive Shaft	36	59.5	40	814	
	2003.08-2010.05	6DCT	F	L	MPV FWD BKC/BLS/BXE		2033810L	Drive Shaft	36	59.5	40	485	
	2003.08-2010.05	6DCT	F	L	MPV FWD BKC/BLS/BXE		2540130L	Drive Shaft	36	59.5	40.5	482	
	2003.08-2010.05	6DCT	F	R	MPV FWD BKC/BLS/BXE		2540110L	Drive Shaft	36	59.5	40.5	760	
	2003.08-2010.05	6MT	F	L	MPV FWD BKC/BLS/BXE	Date to:2009.10,For PR code:0EJ	2032940L	Drive Shaft	36	59.5	40	517	
	2003.08-2010.05	6MT	F	L	MPV FWD BKC/BLS/BXE	For PR code:0EN	2032950L	Drive Shaft	36	59.5	40.5	486	
	2003.08-2010.05	6MT	F	L	MPV FWD BKC/BLS/BXE	Date from:2009.11,For PR code:0EJ	2612820L	Drive Shaft	36	59.5	40	523	
	2003.08-2010.05	6MT	F	R	MPV FWD BKC/BLS/BXE	For PR code:0EN	2033130L	Drive Shaft	36	59.5	40.5	794	
	2003.08-2010.05	6MT	F	R	MPV FWD BKC/BLS/BXE	Date to:2009.10,For PR code:0EJ	2610420L	Drive Shaft	36	59.5	40	814	
	2003.08-2010.05	6MT	F	R	MPV FWD BKC/BLS/BXE	Date from:2009.11,For PR code:0EJ	2612830L	Drive Shaft	36	59.5	40	815	
	2003.08-2010.05	7DCT	F	L	MPV FWD BKC/BLS/BXE	Date from:2008.11	2611000L	Drive Shaft	36	59.5	40.5	514	
	2.0 (80 kw)	2006.02-2009.05	5MT	F	L	MPV FWD BSX		2033730L	Drive Shaft	36	59.5	40	517
		2006.02-2009.05	5MT	F	R	MPV FWD BSX		2610420L	Drive Shaft	36	59.5	40	814
2.0 (81 kw)	2010.05-2015.05	6DCT	F	L	MPV FWD CFHF/CLCA		2540130L	Drive Shaft	36	59.5	40.5	482	
	2010.05-2015.05	6DCT	F	R	MPV FWD CFHF/CLCA		2540110L	Drive Shaft	36	59.5	40.5	760	
	2010.05-2015.05	6MT	F	L	MPV FWD CFHF/CLCA		2032940L	Drive Shaft	36	59.5	40	517	
	2010.05-2015.05	6MT	F	R	MPV FWD CFHF/CLCA		2610420L	Drive Shaft	36	59.5	40	814	
	2015.11-2019.07	6MT	F	L	MPV FWD CRVA/CYKB/DFEB/DFGB		2611000L	Drive Shaft	36	59.5	40.5	514	
	2015.11-2019.07	6MT	F	R	MPV FWD CRVA/CYKB/DFEB/DFGB		2613410L	Drive Shaft	36	59.5	40.5	806	
	2015.11-2019.07	AT/7DCT	F	R	MPV FWD CRVA/CYKB/DFEB/DFGB	Date From:2016.01	2612830L	Drive Shaft	36	59.5	40	815	
2.0 (85 kw)	2015.11-2019.07				MPV FWD CRVA/CYKB/DFEB/DFGB		2612010L	Drive Shaft	36	59.5	40	536	
	2019.02-	6MT	F	L	MPV FWD DFGC		2611000L	Drive Shaft	36	59.5	40.5	514	
	2019.02-	6MT	F	R	MPV FWD DFGC		2613410L	Drive Shaft	36	59.5	40.5	806	
	2019.02-	7DCT	F	L	MPV FWD DFGC		2023510L	Drive Shaft	36	37	59.5	40	570
	2019.02-	7DCT	F	R	MPV FWD DFGC		2036130L	Drive Shaft	36	37	59.5	40	921

 YEAR	TRANSM.	F/R	L/R	BODY STYLE & DRIVE TYPE & ENGINE	REMARKS	GSP Ref.	 PRODUCT	 ABS	Technical Specifications				
									A	B	C	H	L
VW													
Touran													
2.0 (100 kw)	2003.02-2010.05	6MT	F	L	MPV FWD AZV	For PR code:F5A/RFF4G/F4J/For PR code:Q2F4G/F4K/SF5/F6L	2032950L	Drive Shaft	36		59.5	40.5	486
	2003.02-2010.05	6MT	F	R	MPV FWD AZV	For PR code:F5A/RFF4G/F4J/For PR code:Q2F4G/F4K/SF5/F6L	2033130L	Drive Shaft	36		59.5	40.5	794
	2003.02-2010.05	AT	F	R	MPV FWD AZV	Date From:2004.01,Date From:2004.11	2540110L	Drive Shaft	36		59.5	40.5	760
	2003.02-2010.05	MT	F	R	MPV FWD AZV		2033800L	Drive Shaft	36		59.5	40	487
	2003.02-2010.05		F	R	MPV FWD AZV	Date From:2008.03/For PR code:F4E/F4W/SF5/F6L	2611470L	Drive Shaft	36		59.5	40.5	795
2.0 (103 kw)	2003.08-2010.05	6DCT	F	R	MPV FWD BKD	AAR	2033540L	Drive Shaft	36		59.5	40	760
	2003.08-2010.05	AT	F	L	MPV FWD BKD	Date From:2008.08,Date To:2009.01/For PR code:F4E/F4W/SF5/F6L	2033810L	Drive Shaft	36		59.5	40	485
	2003.08-2010.05	AT	F	L	MPV FWD BKD	Date From:2009.02/For PR code:F4E/F4W/SF5/F6L	2033810L	Drive Shaft	36		59.5	40	485
	2003.08-2010.05	AT	F	L	MPV FWD BKD	For PR code:F5A/RFF4G/F4J/For PR code:Q2F4G/F4K/SF5/F6L	2540130L	Drive Shaft	36		59.5	40.5	482
	2003.08-2010.05	AT	F	R	MPV FWD BKD	For PR code:F5A/RFF4G/F4J/For PR code:Q2F4G/F4K/SF5/F6L	2540110L	Drive Shaft	36		59.5	40.5	760
	2003.08-2010.05	MT	F	L	MPV FWD BKD	Date From:2008.11/For PR code:F5A/RFF4G/F4J/For PR code:Q2F4G/F4K/SF5/F6L	2032950L	Drive Shaft	36		59.5	40.5	486
	2003.08-2010.05	MT	F	R	MPV FWD BKD	Date From:2008.11/For PR code:F5A/RFF4G/F4J/For PR code:Q2F4G/F4K/SF5/F6L	2033130L	Drive Shaft	36		59.5	40.5	794
	2003.08-2010.05		F	R	MPV FWD BKD	Date From:2008.03/For PR code:F4E/F4W/SF5/F6L	2611470L	Drive Shaft	36		59.5	40.5	795
	2005.12-2010.05	6DCT	F	L	MPV FWD BMM		2033810L	Drive Shaft	36		59.5	40	485
	2005.12-2010.05	6DCT	F	L	MPV FWD BMM		2540130L	Drive Shaft	36		59.5	40.5	482
	2005.12-2010.05	6DCT	F	R	MPV FWD BMM	For Modelcode:1T2/For PR code:F4E/F4W/SF5/F6L	2033540L	Drive Shaft	36		59.5	40	760
	2005.12-2010.05	6DCT	F	R	MPV FWD BMM		2540110L	Drive Shaft	36		59.5	40.5	760
	2005.12-2010.05	6MT	F	L	MPV FWD BMM		2032950L	Drive Shaft	36		59.5	40.5	486
	2005.12-2010.05	6MT	F	R	MPV FWD BMM		2033130L	Drive Shaft	36		59.5	40.5	794
	2005.12-2010.05	6MT	F	R	MPV FWD BMM	For Modelcode:1T2/For PR code:F4E/F4W/SF5/F6L	2611470L	Drive Shaft	36		59.5	40.5	795
	2010.05-2015.05	6DCT	F	L	MPV FWD CFHC		2033810L	Drive Shaft	36		59.5	40	485
	2010.05-2015.05	6DCT	F	L	MPV FWD CFHC		2540130L	Drive Shaft	36		59.5	40.5	482
	2010.05-2015.05	6DCT	F	R	MPV FWD CFHC		2540110L	Drive Shaft	36		59.5	40.5	760
	2010.05-2015.05	6MT	F	L	MPV FWD CFHC	Rims:With alloy rim	2032950L	Drive Shaft	36		59.5	40.5	486
	2010.05-2015.05	6MT	F	L	MPV FWD CFHC	Rims:With steel rim	2033800L	Drive Shaft	36		59.5	40	487
	2010.05-2015.05	6MT	F	R	MPV FWD CFHC		2033130L	Drive Shaft	36		59.5	40.5	794
	2010.05-2015.05	MT	F	L	MPV FWD CFHC		2033800L	Drive Shaft	36		59.5	40	487
2.0 (110 kw)	2003.10-2006.11	AT	F	R	MPV FWD AXW/BLR/BLX/BLY		2610940L	Drive Shaft	36	26	59.5	40	884
	2003.10-2006.11	MT	F	L	MPV FWD AXW/BLR/BLX/BLY		2032940L	Drive Shaft	36		59.5	40	517
	2003.10-2006.11	MT	F	R	MPV FWD AXW/BLR/BLX/BLY		2610420L	Drive Shaft	36		59.5	40	814
	2015.05-	6DCT	F	L	MPV FWD DFEA/DFGA/DTSB		2033810L	Drive Shaft	36		59.5	40	485
	2015.05-	6DCT	F	R	MPV FWD DFEA/DFGA/DTSB		2613450L	Drive Shaft	36		59.5	40	774
	2015.05-	6MT	F	L	MPV FWD DFEA/DFGA/DTSB		2611000L	Drive Shaft	36		59.5	40.5	514
	2015.05-	6MT	F	R	MPV FWD DFEA/DFGA/DTSB		2613410L	Drive Shaft	36		59.5	40.5	806
	2015.05-	7DCT	F	L	MPV FWD DFEA/DFGA/DTSB		2023510L	Drive Shaft	36	37	59.5	40	570
	2015.05-	7DCT	F	R	MPV FWD DFEA/DFGA/DTSB		2036130L	Drive Shaft	36	37	59.5	40	921
	2020.11-	7DCT	F	R	MPV Van FWD DTSB		2036130L	Drive Shaft	36	37	59.5	40	921
2.0 (125 kw)	2005.12-2010.05	AT	F	L	MPV FWD BMN/CFJA	Date From:2008.08,Date To:2009.01/For PR code:F4E/F4W/SF5/F6L	2033810L	Drive Shaft	36		59.5	40	485
	2005.12-2010.05	AT	F	L	MPV FWD BMN/CFJA	Date From:2009.02/For PR code:F4E/F4W/SF5/F6L	2033810L	Drive Shaft	36		59.5	40	485
	2005.12-2010.05	AT	F	L	MPV FWD BMN/CFJA		2540130L	Drive Shaft	36		59.5	40.5	482
	2005.12-2010.05	AT	F	R	MPV FWD BMN/CFJA		2540110L	Drive Shaft	36		59.5	40.5	760
	2005.12-2010.05	MT	F	L	MPV FWD BMN/CFJA		2032950L	Drive Shaft	36		59.5	40.5	486
	2005.12-2010.05	MT	F	L	MPV FWD BMN/CFJA		2033800L	Drive Shaft	36		59.5	40	487
	2005.12-2010.05	MT	F	R	MPV FWD BMN/CFJA	Date From:2008.03/For PR code:F4E/F4W/SF5/F6L	2033130L	Drive Shaft	36		59.5	40.5	794
	2005.12-2010.05		F	R	MPV FWD BMN/CFJA	Date From:2008.03/For PR code:F4E/F4W/SF5/F6L	2611470L	Drive Shaft	36		59.5	40.5	795
	2010.05-2013.01	6AT	F	L	MPV FWD CFJA		2540130L	Drive Shaft	36		59.5	40.5	482
	2010.05-2013.01	6AT	F	R	MPV FWD CFJA	AAR	2033540L	Drive Shaft	36		59.5	40	760
	2010.05-2013.01	AT	F	L	MPV FWD CFJA	Date From:2009.02/For PR code:F4E/F4W/SF5/F6L	2033810L	Drive Shaft	36		59.5	40	485
2.0 (130 kw)	2013.01-2015.05	6AT	F	R	MPV FWD CFJB		2033540L	Drive Shaft	36		59.5	40	760
2.0 (140 kw)	2015.11-2019.07	6AT	F	L	MPV FWD DFHA		2033810L	Drive Shaft	36		59.5	40	485
	2015.11-2019.07	6AT	F	R	MPV FWD DFHA		2613450L	Drive Shaft	36		59.5	40	774
	2015.11-2019.07	7DCT	F	L	MPV FWD DFHA		2023510L	Drive Shaft	36	37	59.5	40	570
	2015.11-2019.07	7DCT	F	R	MPV FWD DFHA		2036130L	Drive Shaft	36	37	59.5	40	921
	2015.11-2019.07	MT	F	L	MPV FWD DFHA	Date From:2016.01	2611000L	Drive Shaft	36		59.5	40.5	514
	2015.11-2019.07	MT	F	R	MPV FWD DFHA	Date From:2016.01	2613410L	Drive Shaft	36		59.5	40.5	806
Transporter													
1.9 (62 kw)	2006.01-2009.11	5MT	F	L	Platform/Chassis FWD BRR	6 balls	2611050L	Drive Shaft	38		63	102.5	645
	2006.01-2009.11	5MT	F	L	Van FWD BRR	6 balls	2611050L	Drive Shaft	38		63	102.5	645
1.9 (63 kw)	2003.04-2009.11	5MT	F	L	Platform/Chassis FWD AXC	6 balls	2611050L	Drive Shaft	38		63	102.5	645
	2003.04-2009.11	5MT	F	L	Van FWD AXC	6 balls	2611050L	Drive Shaft	38		63	102.5	645
1.9 (75 kw)	2006.01-2009.11	5MT	F	L	Platform/Chassis FWD BRS	6 balls	2611050L	Drive Shaft	38		63	102.5	645
	2006.01-2009.11	5MT	F	L	Van FWD BRS	6 balls	2611050L	Drive Shaft	38		63	102.5	645
1.9 (77 kw)	2003.04-2009.11	5MT	F	L	Platform/Chassis FWD AXB	6 balls	2611050L	Drive Shaft	38		63	102.5	645
	2003.04-2009.11	5MT	F	L	Van FWD AXB	6 balls	2611050L	Drive Shaft	38		63	102.5	645
2.0 (62 kw)	2009.08-2015.08	5MT	F	L	Platform/Chassis FWD CAAA	6 balls	2611050L	Drive Shaft	38		63	102.5	645



 YEAR	TRANSM.	F/R	L/R	BODY STYLE & DRIVE TYPE & ENGINE	REMARKS	GSP Ref.	 PRODUCT	 ABS	Technical Specifications				
									A	B	C	H	L
VW Transporter													
2.0 (62 kw)													
2009.08-2015.08	5MT	F	R	Platform/Chassis FWD CAAA		2032610L	Drive Shaft		38	26	63	102.5	857
2009.09-2015.08	5MT	F	L	Bus FWD CAAA	6 balls	2611050L	Drive Shaft		38		63	102.5	645
2009.09-2015.08	5MT	F	R	Bus FWD CAAA		2032610L	Drive Shaft		38	26	63	102.5	857
2009.09-2015.08	5MT	F	L	Van FWD CAAA	6 balls	2611050L	Drive Shaft		38		63	102.5	645
2009.09-2015.08	5MT	F	R	Van FWD CAAA		2032610L	Drive Shaft		38	26	63	102.5	857
2015.04-	5MT	F	L	Bus FWD CAAA/CXGA	Date To:2017.03	2611050L	Drive Shaft		38		63	102.5	645
2015.04-	5MT	F	R	Bus FWD CAAA/CXGA	Date To:2017.03	2032610L	Drive Shaft		38	26	63	102.5	857
2015.04-2019.07	5MT	F	L	Van FWD CAAA/CXGA	Date To:2017.03	2611050L	Drive Shaft		38		63	102.5	645
2015.04-2019.11	5MT	F	L	Platform/Chassis FWD CAAA/CXGA	Date To:2017.03	2611050L	Drive Shaft		38		63	102.5	645
2015.04-2019.11	5MT	F	R	Platform/Chassis FWD CAAA/CXGA	Date To:2017.03	2032610L	Drive Shaft		38	26	63	102.5	857
2.0 (75 kw)													
2009.09-2015.08	5MT	F	L	Platform/Chassis FWD CAAB	6 balls	2611050L	Drive Shaft		38		63	102.5	645
2009.09-2015.08	5MT	F	R	Platform/Chassis FWD CAAB		2032610L	Drive Shaft		38	26	63	102.5	857
2009.09-2015.08	5MT	F	L	Van FWD CAAB	6 balls	2611050L	Drive Shaft		38		63	102.5	645
2009.09-2015.08	5MT	F	R	Van FWD CAAB		2032610L	Drive Shaft		38	26	63	102.5	857
2011.04-2015.08	5MT	F	L	Bus FWD CAAB	6 balls	2611050L	Drive Shaft		38		63	102.5	645
2011.04-2015.08	5MT	F	R	Bus FWD CAAB		2032610L	Drive Shaft		38	26	63	102.5	857
2015.04-	5MT	F	L	Bus FWD CAAB/CXGB	Date To:2017.03	2611050L	Drive Shaft		38		63	102.5	645
2015.04-	5MT	F	R	Bus FWD CAAB/CXGB	Date To:2017.03	2032610L	Drive Shaft		38	26	63	102.5	857
2015.04-2019.11	5MT	F	L	Platform/Chassis FWD CAAB/CXGB	Date To:2017.03	2611050L	Drive Shaft		38		63	102.5	645
2015.04-2019.11	5MT	F	R	Platform/Chassis FWD CAAB/CXGB	Date To:2017.03	2032610L	Drive Shaft		38	26	63	102.5	857
2015.04-2019.12	5MT	F	L	Van FWD CAAB/CXGB	Date To:2017.03	2611050L	Drive Shaft		38		63	102.5	645
2015.04-2019.12	5MT	F	R	Van FWD CAAB/CXGB	Date To:2017.03	2032610L	Drive Shaft		38	26	63	102.5	857
2.0 (84 kw)													
2011.05-2015.08	5MT	F	L	Bus FWD CAAD	6 balls	2611050L	Drive Shaft		38		63	102.5	645
2011.05-2015.08	5MT	F	R	Bus FWD CAAD		2032610L	Drive Shaft		38	26	63	102.5	857
2011.05-2015.08	5MT	F	L	Platform/Chassis FWD CAAD	6 balls	2611050L	Drive Shaft		38		63	102.5	645
2011.05-2015.08	5MT	F	R	Platform/Chassis FWD CAAD		2032610L	Drive Shaft		38	26	63	102.5	857
2011.05-2015.08	5MT	F	L	Van FWD CAAD	6 balls	2611050L	Drive Shaft		38		63	102.5	645
2011.05-2015.08	5MT	F	R	Van FWD CAAD		2032610L	Drive Shaft		38	26	63	102.5	857
2016.05-	5MT	F	L	Bus FWD CXHB	Date To:2017.03	2611050L	Drive Shaft		38		63	102.5	645
2016.05-2019.11	5MT	F	L	Platform/Chassis FWD CXHB	Date To:2017.03	2611050L	Drive Shaft		38		63	102.5	645
2.0 (85 kw)													
2003.11-2011.05	5MT	F	L	Platform/Chassis FWD AXACNG	6 balls	2611050L	Drive Shaft		38		63	102.5	645
2003.11-2015.08	5MT	F	L	Platform/Chassis FWD AXA	6 balls	2611050L	Drive Shaft		38		63	102.5	645
2003.11-2015.08	5MT	F	L	Van FWD AXA	6 balls	2611050L	Drive Shaft		38		63	102.5	645
2009.09-2013.05	5MT	F	L	Bus FWD AXA	6 balls	2611050L	Drive Shaft		38		63	102.5	645
2009.09-2015.08	5MT	F	L	Bus FWD AXACNG	6 balls	2611050L	Drive Shaft		38		63	102.5	645
2.0 (100 kw)													
2010.05-2015.08	6MT	F	L	Bus 4WD CAAE/CCHB	Date From:2013.07	2033600L	Drive Shaft		38	42	63	102.5	617
2010.05-2015.08	6MT	F	L	Bus 4WD CAAE/CCHB		2610840L	Drive Shaft		38	26	63	102.5	616
2010.05-2015.08	6MT	F	R	Bus 4WD CAAE/CCHB	Date from:2013.07	2016660L	Drive Shaft		38	26	63	102.5	616
2010.05-2015.08	6MT	F	R	Bus 4WD CAAE/CCHB	Date to:2013.06	2610840L	Drive Shaft		38	26	63	102.5	616
2010.05-2015.08	6MT	R	L	Bus 4WD CAAE/CCHB		2612570L	Drive Shaft		38		59	102	683
2010.05-2015.08	6MT	R	R	Bus 4WD CAAE/CCHB		2612580L	Drive Shaft		38		59	102	743
2010.05-2015.08	6MT	F	L	Bus FWD CAAE/CCHB	Date From:2013.07	2033600L	Drive Shaft		38	42	63	102.5	617
2010.05-2015.08	6MT	F	L	Bus FWD CAAE/CCHB	Date to:2013.06	2610840L	Drive Shaft		38	26	63	102.5	616
2010.05-2015.08	6MT	F	R	Bus FWD CAAE/CCHB	Date From:2013.07,Date To:2015.04	2023610L	Drive Shaft		38	26	63	102.5	879
2010.05-2015.08	6MT	F	R	Bus FWD CAAE/CCHB		2032960L	Drive Shaft		38	26	63	102.5	880
2010.05-2015.08	6MT	F	R	Bus FWD CAAE/CCHB	Date From:2015.05	2033610L	Drive Shaft		38	26	63	102.5	881
2010.05-2015.08	7DCT	F	L	Bus FWD CAAE/CCHB		2032930L	Drive Shaft		38	37	63	102.5	647
2010.05-2015.08	7DCT	F	R	Bus FWD CAAE/CCHB	Chassis no. from:7HC5000001/7HC4500001/7HC3000001	2023920L	Drive Shaft		38	37	63	102.5	1026
2010.05-2015.08	7DCT	F	R	Bus FWD CAAE/CCHB	Chassis no. to:7HB5000000/7HB4500000/7HB3000000	2033530L	Drive Shaft		38	37	63	102.5	1026
2010.05-2015.08	6MT	F	L	Platform/Chassis 4WD CAAE/CCHB	Date From:2013.07	2033600L	Drive Shaft		38	42	63	102.5	617
2010.05-2015.08	6MT	F	R	Platform/Chassis 4WD CAAE/CCHB	Date from:2013.07	2016660L	Drive Shaft		38	26	63	102.5	616
2010.05-2015.08	6MT	F	L/R	Platform/Chassis 4WD CAAE/CCHB	Date to:2013.06	2610840L	Drive Shaft		38	26	63	102.5	616
2010.05-2015.08	6MT	R	L	Platform/Chassis 4WD CAAE/CCHB		2612570L	Drive Shaft		38		59	102	683
2010.05-2015.08	6MT	R	R	Platform/Chassis 4WD CAAE/CCHB		2612580L	Drive Shaft		38		59	102	743
2010.05-2015.08	6MT	F	L	Platform/Chassis FWD CAAE	Date From:2013.07	2033600L	Drive Shaft		38	42	63	102.5	617
2010.05-2015.08	6MT	F	L	Platform/Chassis FWD CAAE	Date to:2013.06	2610840L	Drive Shaft		38	26	63	102.5	616
2010.05-2015.08	6MT	F	R	Platform/Chassis FWD CAAE	Date From:2013.07,Date To:2015.04	2023610L	Drive Shaft		38	26	63	102.5	879
2010.05-2015.08	6MT	F	R	Platform/Chassis FWD CAAE	Date To:2013.06	2032960L	Drive Shaft		38	26	63	102.5	880
2010.05-2015.08	6MT	F	R	Platform/Chassis FWD CAAE	Date From:2015.05	2033610L	Drive Shaft		38	26	63	102.5	881
2010.05-2015.08	7DCT	F	L	Platform/Chassis FWD CAAE		2032930L	Drive Shaft		38	37	63	102.5	647
2010.05-2015.08	7DCT	F	R	Platform/Chassis FWD CAAE	Date From:2013.06	2023920L	Drive Shaft		38	37	63	102.5	1026
2010.05-2015.08	7DCT	F	R	Platform/Chassis FWD CAAE	Date To:2013.05	2033530L	Drive Shaft		38	37	63	102.5	1026
2010.05-2015.08	6MT	F	L	Van 4WD CAAE/CCHB	Date From:2013.07	2033600L	Drive Shaft		38	42	63	102.5	617
2010.05-2015.08	6MT	F	L	Van 4WD CAAE/CCHB		2610840L	Drive Shaft		38	26	63	102.5	616
2010.05-2015.08	6MT	F	R	Van 4WD CAAE/CCHB	Date from:2013.07	2016660L	Drive Shaft		38	26	63	102.5	616



YEAR	TRANSM.	F/R	L/R	BODY STYLE & DRIVE TYPE & ENGINE	REMARKS	GSP Ref.	PRODUCT	ABS	Technical Specifications				
									A	B	C	H	L
VW Transporter													
2.0 (100 kw)													
2010.05-2015.08	6MT	F	R	Van 4WD CAAE/CCHB	Date to:2013.06	2610840L	Drive Shaft		38	26	63	102.5	616
2010.05-2015.08	6MT	R	L	Van 4WD CAAE/CCHB		2612570L	Drive Shaft		38		59	102	683
2010.05-2015.08	6MT	R	R	Van 4WD CAAE/CCHB		2612580L	Drive Shaft		38		59	102	743
2010.05-2015.08	6MT	F	L	Van FWD CAAE/CCHB	Date From:2013.07	2033600L	Drive Shaft		38	42	63	102.5	617
2010.05-2015.08	6MT	F	L	Van FWD CAAE/CCHB	Date to:2013.06	2610840L	Drive Shaft		38	26	63	102.5	616
2010.05-2015.08	6MT	F	R	Van FWD CAAE/CCHB	Date From:2013.07,Date To:2015.04	2023610L	Drive Shaft		38	26	63	102.5	879
2010.05-2015.08	6MT	F	R	Van FWD CAAE/CCHB		2032960L	Drive Shaft		38	26	63	102.5	880
2010.05-2015.08	6MT	F	R	Van FWD CAAE/CCHB	Date From:2015.05	2033610L	Drive Shaft		38	26	63	102.5	881
2010.05-2015.08	7DCT	F	L	Van FWD CAAE/CCHB		2032930L	Drive Shaft		38	37	63	102.5	647
2010.05-2015.08	7DCT	F	R	Van FWD CAAE/CCHB	Chassis no. from:7HC000001/7HC400001/7HCX00001	2023920L	Drive Shaft		38	37	63	102.5	1026
2010.05-2015.08	7DCT	F	R	Van FWD CAAE/CCHB	Chassis no. to:7HB0500000/7HB4500000/7HBX500000	2033530L	Drive Shaft		38	37	63	102.5	1026
2.0 (103 kw)													
2009.09-2015.08	6MT	F	L	Bus FWD CAAC/CCHA	Date From:2013.07	2033600L	Drive Shaft		38	42	63	102.5	617
2009.09-2015.08	6MT	F	L	Bus FWD CAAC/CCHA	Date to:2013.06	2610840L	Drive Shaft		38	26	63	102.5	616
2009.09-2015.08	6MT	F	R	Bus FWD CAAC/CCHA	Date From:2013.07,Date To:2015.04	2023610L	Drive Shaft		38	26	63	102.5	879
2009.09-2015.08	6MT	F	R	Bus FWD CAAC/CCHA		2032960L	Drive Shaft		38	26	63	102.5	880
2009.09-2015.08	6MT	F	R	Bus FWD CAAC/CCHA	Date From:2015.05	2033610L	Drive Shaft		38	26	63	102.5	881
2009.09-2015.08	7DCT	F	L	Bus FWD CAAC/CCHA		2032930L	Drive Shaft		38	37	63	102.5	647
2009.09-2015.08	7DCT	F	R	Bus FWD CAAC/CCHA	Chassis no. From:7HC000001/7HC400001/7HCX00001	2023920L	Drive Shaft		38	37	63	102.5	1026
2009.09-2015.08	7DCT	F	R	Bus FWD CAAC/CCHA	Chassis no. To:7HB0500000/7HB4500000/7HBX500000	2033530L	Drive Shaft		38	37	63	102.5	1026
2009.09-2015.08	6MT	F	L	Platform/Chassis 4WD CAAC/CCHA	Date From:2013.07	2033600L	Drive Shaft		38	42	63	102.5	617
2009.09-2015.08	6MT	F	R	Platform/Chassis 4WD CAAC/CCHA	Date from:2013.07	2016660L	Drive Shaft		38	26	63	102.5	616
2009.09-2015.08	6MT	F	L/R	Platform/Chassis 4WD CAAC/CCHA	Date to:2013.06	2610840L	Drive Shaft		38	26	63	102.5	616
2009.09-2015.08	AT	F	L	Platform/Chassis 4WD CAAC/CCHA		2032930L	Drive Shaft		38	37	63	102.5	647
2009.09-2015.08	AT	F	R	Platform/Chassis 4WD CAAC/CCHA		2033530L	Drive Shaft		38	37	63	102.5	1026
2009.09-2015.08	6MT	R	L	Platform/Chassis 4WD CAAC/CCHA		2612570L	Drive Shaft		38		59	102	683
2009.09-2015.08	6MT	R	R	Platform/Chassis 4WD CAAC/CCHA		2612580L	Drive Shaft		38		59	102	743
2009.09-2015.08	6MT	F	L	Platform/Chassis FWD CAAC/CCHA	Date From:2013.07	2033600L	Drive Shaft		38	42	63	102.5	617
2009.09-2015.08	6MT	F	L	Platform/Chassis FWD CAAC/CCHA	Date to:2013.06	2610840L	Drive Shaft		38	26	63	102.5	616
2009.09-2015.08	6MT	F	R	Platform/Chassis FWD CAAC/CCHA	Date From:2013.07,Date To:2015.04	2023610L	Drive Shaft		38	26	63	102.5	879
2009.09-2015.08	6MT	F	R	Platform/Chassis FWD CAAC/CCHA	Date To:2013.06	2032960L	Drive Shaft		38	26	63	102.5	880
2009.09-2015.08	6MT	F	R	Platform/Chassis FWD CAAC/CCHA	Date From:2015.05	2033610L	Drive Shaft		38	26	63	102.5	881
2009.09-2015.08	7DCT	F	L	Platform/Chassis FWD CAAC/CCHA		2032930L	Drive Shaft		38	37	63	102.5	647
2009.09-2015.08	7DCT	F	R	Platform/Chassis FWD CAAC/CCHA	Chassis no. From:7HC000001/7HC400001/7HCX00001	2023920L	Drive Shaft		38	37	63	102.5	1026
2009.09-2015.08	7DCT	F	R	Platform/Chassis FWD CAAC/CCHA	Chassis no. To:7HB0500000/7HB4500000/7HBX500000	2033530L	Drive Shaft		38	37	63	102.5	1026
2009.09-2015.08	6MT	F	L	Van 4WD CAAC/CCHA	Date From:2013.07	2033600L	Drive Shaft		38	42	63	102.5	617
2009.09-2015.08	6MT	F	L	Van 4WD CAAC/CCHA		2610840L	Drive Shaft		38	26	63	102.5	616
2009.09-2015.08	6MT	F	R	Van 4WD CAAC/CCHA	Date from:2013.07	2016660L	Drive Shaft		38	26	63	102.5	616
2009.09-2015.08	6MT	F	R	Van 4WD CAAC/CCHA	Date to:2013.06	2610840L	Drive Shaft		38	26	63	102.5	616
2009.09-2015.08	AT	F	L	Van 4WD CAAC/CCHA		2032930L	Drive Shaft		38	37	63	102.5	647
2009.09-2015.08	AT	F	R	Van 4WD CAAC/CCHA		2033530L	Drive Shaft		38	37	63	102.5	1026
2009.09-2015.08	6MT	R	L	Van 4WD CAAC/CCHA		2612570L	Drive Shaft		38		59	102	683
2009.09-2015.08	6MT	R	R	Van 4WD CAAC/CCHA		2612580L	Drive Shaft		38		59	102	743
2009.09-2015.08	6MT	F	L	Van FWD CAAC/CCHA	Date From:2013.07	2033600L	Drive Shaft		38	42	63	102.5	617
2009.09-2015.08	6MT	F	L	Van FWD CAAC/CCHA	Date to:2013.06	2610840L	Drive Shaft		38	26	63	102.5	616
2009.09-2015.08	6MT	F	R	Van FWD CAAC/CCHA	Date From:2013.07,Date To:2015.04	2023610L	Drive Shaft		38	26	63	102.5	879
2009.09-2015.08	6MT	F	R	Van FWD CAAC/CCHA		2032960L	Drive Shaft		38	26	63	102.5	880
2009.09-2015.08	6MT	F	R	Van FWD CAAC/CCHA	Date From:2015.05	2033610L	Drive Shaft		38	26	63	102.5	881
2009.09-2015.08	7DCT	F	L	Van FWD CAAC/CCHA		2032930L	Drive Shaft		38	37	63	102.5	647
2009.09-2015.08	7DCT	F	R	Van FWD CAAC/CCHA	Chassis no. from:7HC000001/7HC400001/7HCX00001	2023920L	Drive Shaft		38	37	63	102.5	1026
2009.09-2015.08	7DCT	F	R	Van FWD CAAC/CCHA	Chassis no. to:7HB0500000/7HB4500000/7HBX500000	2033530L	Drive Shaft		38	37	63	102.5	1026
2009.10-2015.08	6MT	F	L	Bus 4WD CAAC/CCHA	Date From:2013.07	2033600L	Drive Shaft		38	42	63	102.5	617
2009.10-2015.08	6MT	F	L	Bus 4WD CAAC/CCHA		2610840L	Drive Shaft		38	26	63	102.5	616
2009.10-2015.08	6MT	F	R	Bus 4WD CAAC/CCHA	Date from:2013.07	2016660L	Drive Shaft		38	26	63	102.5	616
2009.10-2015.08	6MT	F	R	Bus 4WD CAAC/CCHA	Date to:2013.06	2610840L	Drive Shaft		38	26	63	102.5	616
2009.10-2015.08	6MT	R	L	Bus 4WD CAAC/CCHA		2612570L	Drive Shaft		38		59	102	683
2009.10-2015.08	6MT	R	R	Bus 4WD CAAC/CCHA		2612580L	Drive Shaft		38		59	102	743
2015.04-	6MT	F	L	Bus FWD CAAC		2033600L	Drive Shaft		38	42	63	102.5	617
2015.04-	6MT	F	L	Bus FWD CAAC	Date to:2017.01	2610840L	Drive Shaft		38	26	63	102.5	616
2015.04-	6MT	F	R	Bus FWD CAAC		2033610L	Drive Shaft		38	26	63	102.5	881
2015.04-	7DCT	F	L	Bus FWD CAAC		2032930L	Drive Shaft		38	37	63	102.5	647
2015.04-	7DCT	F	R	Bus FWD CAAC	8 balls	2032920L	Drive Shaft		38	37	63	102.5	1026
2015.04-	7DCT	F	R	Bus FWD CAAC	Date to:2017.01	2033530L	Drive Shaft		38	37	63	102.5	1026
2015.04-2019.11	6MT	F	L	Platform/Chassis FWD CAAC	Date To:2017.01	2033600L	Drive Shaft		38	42	63	102.5	617
2015.04-2019.11	6MT	F	L	Platform/Chassis FWD CAAC	Date to:2017.01	2610840L	Drive Shaft		38	26	63	102.5	616
2015.04-2019.11	6MT	F	R	Platform/Chassis FWD CAAC	Date To:2017.01	2033610L	Drive Shaft		38	26	63	102.5	881

YEAR	TRANSM.	F/R	L/R	BODY STYLE & DRIVE TYPE & ENGINE	REMARKS	GSP Ref.	PRODUCT	ABS	Technical Specifications						
									A	B	C	H	L		
VW Transporter															
2.0 (103 kw)															
2015.04-2019.11	7DCT	F	L	Platform/Chassis FWD CAAC		2032930L	Drive Shaft		38	37	63	102.5	647		
2015.04-2019.11	7DCT	F	R	Platform/Chassis FWD CAAC		2023920L	Drive Shaft		38	37	63	102.5	1026		
2015.04-2019.12	6MT	F	L	Van FWD CAAC		2033600L	Drive Shaft		38	42	63	102.5	617		
2015.04-2019.12	6MT	F	L	Van FWD CAAC	Date to:2017.01	2610840L	Drive Shaft		38	26	63	102.5	616		
2015.04-2019.12	6MT	F	R	Van FWD CAAC	Date to:2017.01	2033610L	Drive Shaft		38	26	63	102.5	881		
2015.04-2019.12	7DCT	F	L	Van FWD CAAC		2032930L	Drive Shaft		38	37	63	102.5	647		
2015.04-2019.12	7DCT	F	R	Van FWD CAAC	8 balls	2023920L	Drive Shaft		38	37	63	102.5	1026		
2015.04-2019.12	7DCT	F	R	Van FWD CAAC	Date to:2017.01	2033530L	Drive Shaft		38	37	63	102.5	1026		
2015.06-	6MT	F	L	Bus 4WD CAAC	Date To:2017.01	2033600L	Drive Shaft		38	42	63	102.5	617		
2015.06-	6MT	F	L	Bus 4WD CAAC	Date to:2017.01	2610840L	Drive Shaft		38	26	63	102.5	616		
2015.06-	6MT	F	R	Bus 4WD CAAC	Date to:2017.01	2016660L	Drive Shaft		38	26	63	102.5	616		
2015.06-	AT	F	L	Bus 4WD CAAC		2032930L	Drive Shaft		38	37	63	102.5	647		
2015.06-	6MT	R	L	Bus 4WD CAAC		2612570L	Drive Shaft		38		59	102	683		
2015.06-	6MT	F/R	R	Bus 4WD CAAC	Date To:2016.04	2612580L	Drive Shaft		38		59	102	743		
2015.06-2019.11	6MT	F	L	Platform/Chassis 4WD CAAC	Date To:2017.01	2033600L	Drive Shaft		38	42	63	102.5	617		
2015.06-2019.11	6MT	F	L	Platform/Chassis 4WD CAAC	Date to:2017.01	2610840L	Drive Shaft		38	26	63	102.5	616		
2015.06-2019.11	6MT	F	R	Platform/Chassis 4WD CAAC	Date to:2017.01	2016660L	Drive Shaft		38	26	63	102.5	616		
2015.06-2019.11	AT	F	L	Platform/Chassis 4WD CAAC		2032930L	Drive Shaft		38	37	63	102.5	647		
2015.06-2019.11	6MT	R	L	Platform/Chassis 4WD CAAC		2612570L	Drive Shaft		38		59	102	683		
2015.06-2019.11	6MT	R	R	Platform/Chassis 4WD CAAC	Date To:2016.04	2612580L	Drive Shaft		38		59	102	743		
2015.06-2019.12	6MT	F	L	Van 4WD CAAC	Date To:2017.01	2033600L	Drive Shaft		38	42	63	102.5	617		
2015.06-2019.12	6MT	F	L	Van 4WD CAAC	Date to:2017.01	2610840L	Drive Shaft		38	26	63	102.5	616		
2015.06-2019.12	6MT	F	R	Van 4WD CAAC		2016660L	Drive Shaft		38	26	63	102.5	616		
2015.06-2019.12	AT	F	L	Van 4WD CAAC		2032930L	Drive Shaft		38	37	63	102.5	647		
2015.06-2019.12	6MT	R	L	Van 4WD CAAC		2612570L	Drive Shaft		38		59	102	683		
2015.06-2019.12	6MT	R	R	Van 4WD CAAC	Date To:2016.04	2612580L	Drive Shaft		38		59	102	743		
2.0 (110 kw)															
2011.05-2015.08	6MT	F	L	Bus FWD CJKB	Date From:2013.07	2033600L	Drive Shaft		38	42	63	102.5	617		
2011.05-2015.08	6MT	F	L	Bus FWD CJKB	Date to:2013.06	2610840L	Drive Shaft		38	26	63	102.5	616		
2011.05-2015.08	6MT	F	R	Bus FWD CJKB	Date From:2013.07,Date To:2015.04	2023610L	Drive Shaft		38	26	63	102.5	879		
2011.05-2015.08	6MT	F	R	Bus FWD CJKB	Date To:2013.06	2032960L	Drive Shaft		38	26	63	102.5	880		
2011.05-2015.08	6MT	F	R	Bus FWD CJKB	Date From:2015.05	2033610L	Drive Shaft		38	26	63	102.5	881		
2012.07-2015.08	6MT	F	L	Platform/Chassis FWD CJKB	Date From:2013.07	2033600L	Drive Shaft		38	42	63	102.5	617		
2012.07-2015.08	6MT	F	L	Platform/Chassis FWD CJKB		2610840L	Drive Shaft		38	26	63	102.5	616		
2012.07-2015.08	6MT	F	R	Platform/Chassis FWD CJKB	Date From:2013.07,Date To:2015.04	2023610L	Drive Shaft		38	26	63	102.5	879		
2012.07-2015.08	6MT	F	R	Platform/Chassis FWD CJKB	Date To:2013.06	2032960L	Drive Shaft		38	26	63	102.5	880		
2012.07-2015.08	6MT	F	R	Platform/Chassis FWD CJKB	Date From:2015.05	2033610L	Drive Shaft		38	26	63	102.5	881		
2012.07-2015.08	AT	F	L	Platform/Chassis FWD CJKB		2032930L	Drive Shaft		38	37	63	102.5	647		
2012.07-2015.08	AT	F	R	Platform/Chassis FWD CJKB		2033530L	Drive Shaft		38	37	63	102.5	1026		
2012.07-2015.08	6MT	F	L	Van FWD CJKB	Date From:2013.07	2033600L	Drive Shaft		38	42	63	102.5	617		
2012.07-2015.08	6MT	F	L	Van FWD CJKB		2610840L	Drive Shaft		38	26	63	102.5	616		
2012.07-2015.08	6MT	F	R	Van FWD CJKB	Date From:2013.07,Date To:2015.04	2023610L	Drive Shaft		38	26	63	102.5	879		
2012.07-2015.08	6MT	F	R	Van FWD CJKB	Date To:2013.06	2032960L	Drive Shaft		38	26	63	102.5	880		
2012.07-2015.08	6MT	F	R	Van FWD CJKB	Date From:2015.05	2033610L	Drive Shaft		38	26	63	102.5	881		
2012.07-2015.08	AT	F	L	Van FWD CJKB		2032930L	Drive Shaft		38	37	63	102.5	647		
2012.07-2015.08	AT	F	R	Van FWD CJKB		2033530L	Drive Shaft		38	37	63	102.5	1026		
2015.04-	6MT	F	L	Bus FWD CJKB	Date From:2013.06	2033600L	Drive Shaft		38	42	63	102.5	617		
2015.04-	6MT	F	L	Bus FWD CJKB	Date to:2017.01	2610840L	Drive Shaft		38	26	63	102.5	616		
2015.04-	6MT	F	R	Bus FWD CJKB	Date From:2012.05	2033610L	Drive Shaft		38	26	63	102.5	881		
2015.04-	7AT	F	L	Bus FWD CJKB		2032930L	Drive Shaft		38	37	63	102.5	647		
2015.04-	6MT	F	L	Bus FWD CXFA/CXHA/DNAA	For Model code:SGB/SGJ	2033600L	Drive Shaft		38	42	63	102.5	617		
2015.04-	6MT	F	R	Bus FWD CXFA/CXHA/DNAA	For Model code:SGB/SGJ	2033610L	Drive Shaft		38	26	63	102.5	881		
2015.04-	7DCT	F	L	Bus FWD CXFA/CXHA/DNAA	Date to:2020.11	2032930L	Drive Shaft		38	37	63	102.5	647		
2015.04-	7DCT	F	R	Bus FWD CXFA/CXHA/DNAA	Date to:2020.11	2023920L	Drive Shaft		38	37	63	102.5	1026		
2015.04-	6MT	F	L	Platform/Chassis FWD CXHA	Date To:2017.01	2033600L	Drive Shaft		38	42	63	102.5	617		
2015.04-	6MT	F	L	Platform/Chassis FWD CXHA	Date to:2017.01,For Modelcode:SFD/SFE/SFL/SFZ	2610840L	Drive Shaft		38	26	63	102.5	616		
2015.04-	6MT	F	R	Platform/Chassis FWD CXHA	Date To:2017.01	2033610L	Drive Shaft		38	26	63	102.5	881		
2015.04-	7DCT	F	L	Platform/Chassis FWD CXHA		2032930L	Drive Shaft		38	37	63	102.5	647		
2015.04-	7DCT	F	R	Platform/Chassis FWD CXHA		2023920L	Drive Shaft		38	37	63	102.5	1026		
2015.04-	6MT	F	L	Van FWD CXFA/CXHA/DNAA	Date To:2017.01	2033600L	Drive Shaft		38	42	63	102.5	617		
2015.04-	6MT	F	L	Van FWD CXFA/CXHA/DNAA	Date to:2017.01,For Modelcode:SGA/SGH	2610840L	Drive Shaft		38	26	63	102.5	616		
2015.04-	6MT	F	R	Van FWD CXFA/CXHA/DNAA	Date To:2017.01	2033610L	Drive Shaft		38	26	63	102.5	881		
2015.04-	7DCT	F	L	Van FWD CXFA/CXHA/DNAA		2032930L	Drive Shaft		38	37	63	102.5	647		
2015.04-	7DCT	F	R	Van FWD CXFA/CXHA/DNAA		2023920L	Drive Shaft		38	37	63	102.5	1026		
2015.04-2019.06	6MT	F	L	Platform/Chassis FWD CJKB	Date From:2013.06	2033600L	Drive Shaft		38	42	63	102.5	617		
2015.04-2019.06	6MT	F	L	Platform/Chassis FWD CJKB	Date to:2017.01	2610840L	Drive Shaft		38	26	63	102.5	616		

YEAR	TRANSM.	F/R	L/R	BODY STYLE & DRIVE TYPE & ENGINE	REMARKS	GSP Ref.	PRODUCT	ABS	Technical Specifications						
									A	B	C	H	L		
VW Transporter															
2.0 (110 kw)															
2015.04-2019.06	6MT	F	R	Platform/Chassis FWD CJKB	Date From:2012.05	2033610L	Drive Shaft		38	26	63	102.5	881		
2015.04-2019.06	7AT	F	L	Platform/Chassis FWD CJKB		2032930L	Drive Shaft		38	37	63	102.5	647		
2015.04-2019.07	6MT	F	L	Van FWD CJKB	Date From:2013.06	2033600L	Drive Shaft		38	42	63	102.5	617		
2015.04-2019.07	6MT	F	L	Van FWD CJKB	Date to:2017.01	2610840L	Drive Shaft		38	26	63	102.5	616		
2015.04-2019.07	6MT	F	R	Van FWD CJKB	Date From:2012.05	2033610L	Drive Shaft		38	26	63	102.5	881		
2015.04-2019.07	7AT	F	L	Van FWD CJKB		2032930L	Drive Shaft		38	37	63	102.5	647		
2015.08-	6MT	F	L	Bus 4WD CXFA/CXHA	For Model code: SGB/SGJ, Date from: 2017.02	2033600L	Drive Shaft		38	42	63	102.5	617		
2015.08-	6MT	F	L	Bus 4WD CXFA/CXHA	Date to: 2017.01, For Model code: SGB/SGJ	2610840L	Drive Shaft		38	26	63	102.5	616		
2015.08-	6MT	F	R	Bus 4WD CXFA/CXHA	Date to: 2017.01, Model code: SGB/SGJ	2016660L	Drive Shaft		38	26	63	102.5	616		
2015.08-	7DCT	F	L	Bus 4WD CXFA/CXHA	Date to: 2020.11	2032930L	Drive Shaft		38	37	63	102.5	647		
2015.08-	7DCT	F	R	Bus 4WD CXFA/CXHA	Date to: 2020.11	2016650L	Drive Shaft		38	26	63	102.5	614		
2015.08-	6MT/7DCT	R	L	Bus 4WD CXFA/CXHA		2612570L	Drive Shaft		38		59	102	683		
2015.08-	6MT/7DCT	R	R	Bus 4WD CXFA/CXHA		2612580L	Drive Shaft		38		59	102	743		
2015.08-	6MT	F	L	Van 4WD CXFA/CXHA/DNAA	Date to: 2017.01, For Model code: SGA/SGH	2610840L	Drive Shaft		38	26	63	102.5	616		
2015.08-	6MT	F	R	Van 4WD CXFA/CXHA/DNAA	Date to: 2017.01, Model code: SGA/SGH	2016660L	Drive Shaft		38	26	63	102.5	616		
2015.08-	7AT/6MT	F	L	Van 4WD CXFA/CXHA/DNAA	Date To: 2017.01	2033600L	Drive Shaft		38	42	63	102.5	617		
2015.08-	AT	F	L	Van 4WD CXFA/CXHA/DNAA		2032930L	Drive Shaft		38	37	63	102.5	647		
2015.08-	6MT/7DCT	R	L	Van 4WD CXFA/CXHA/DNAA		2612570L	Drive Shaft		38		59	102	683		
2015.08-	6MT/7DCT	R	R	Van 4WD CXFA/CXHA/DNAA	Date To: 2016.04	2612580L	Drive Shaft		38		59	102	743		
2016.05-	6MT	F	L	Platform/Chassis 4WD CXHA	Date To: 2017.01	2033600L	Drive Shaft		38	42	63	102.5	617		
2016.05-	6MT	F	L	Platform/Chassis 4WD CXHA	Date to: 2017.01, For Model code: SFD/SFE/SFL	2610840L	Drive Shaft		38	26	63	102.5	616		
2016.05-	6MT	F	R	Platform/Chassis 4WD CXHA	Date to: 2017.01, Model code: SFD/SFE/SFL	2016660L	Drive Shaft		38	26	63	102.5	616		
2016.05-	7DCT	F	L	Platform/Chassis 4WD CXHA		2032930L	Drive Shaft		38	37	63	102.5	647		
2016.05-	7DCT	F	R	Platform/Chassis 4WD CXHA		2016650L	Drive Shaft		38	26	63	102.5	614		
2016.05-	7DCT/6MT	R	L	Platform/Chassis 4WD CXHA		2612570L	Drive Shaft		38		59	102	683		
2.0 (132 kw)															
2009.09-2015.08	6MT	F	L	Bus FWD CFCA	Date From:2013.07	2033600L	Drive Shaft		38	42	63	102.5	617		
2009.09-2015.08	6MT	F	L	Bus FWD CFCA	Date to:2013.06	2610840L	Drive Shaft		38	26	63	102.5	616		
2009.09-2015.08	6MT	F	R	Bus FWD CFCA	Date From:2013.07, Date To:2015.04	2023610L	Drive Shaft		38	26	63	102.5	879		
2009.09-2015.08	6MT	F	R	Bus FWD CFCA		2032960L	Drive Shaft		38	26	63	102.5	880		
2009.09-2015.08	6MT	F	R	Bus FWD CFCA	Date From:2015.05	2033610L	Drive Shaft		38	26	63	102.5	881		
2009.09-2015.08	7DCT	F	L	Bus FWD CFCA		2032930L	Drive Shaft		38	37	63	102.5	647		
2009.09-2015.08	7DCT	F	R	Bus FWD CFCA	Chassis no. From: 7HC0500001/7HC400000/7HCX00001	2023920L	Drive Shaft		38	37	63	102.5	1026		
2009.09-2015.08	7DCT	F	R	Bus FWD CFCA	Chassis no. To: 7HB5500000/7HB4500000/7HBX500000	2033530L	Drive Shaft		38	37	63	102.5	1026		
2009.09-2015.08	6MT	F	L	Platform/Chassis FWD CFCA	Date From:2013.07	2033600L	Drive Shaft		38	42	63	102.5	617		
2009.09-2015.08	6MT	F	L	Platform/Chassis FWD CFCA	Date to:2013.06	2610840L	Drive Shaft		38	26	63	102.5	616		
2009.09-2015.08	6MT	F	R	Platform/Chassis FWD CFCA	Date From:2013.07, Date To:2015.04	2023610L	Drive Shaft		38	26	63	102.5	879		
2009.09-2015.08	6MT	F	R	Platform/Chassis FWD CFCA	Date To:2013.06	2032960L	Drive Shaft		38	26	63	102.5	880		
2009.09-2015.08	6MT	F	R	Platform/Chassis FWD CFCA	Date From:2015.05	2033610L	Drive Shaft		38	26	63	102.5	881		
2009.09-2015.08	7DCT	F	L	Platform/Chassis FWD CFCA		2032930L	Drive Shaft		38	37	63	102.5	647		
2009.09-2015.08	7DCT	F	R	Platform/Chassis FWD CFCA	Chassis no. From: 7HC0500001/7HC400000/7HCX00001	2023920L	Drive Shaft		38	37	63	102.5	1026		
2009.09-2015.08	7DCT	F	R	Platform/Chassis FWD CFCA	Chassis no. To: 7HB5500000/7HB4500000/7HBX500000	2033530L	Drive Shaft		38	37	63	102.5	1026		
2009.09-2015.08	6MT	F	L	Van FWD CFCA	Date From:2013.07	2033600L	Drive Shaft		38	42	63	102.5	617		
2009.09-2015.08	6MT	F	L	Van FWD CFCA	Date to:2013.06	2610840L	Drive Shaft		38	26	63	102.5	616		
2009.09-2015.08	6MT	F	R	Van FWD CFCA	Date From:2013.07, Date To:2015.04	2023610L	Drive Shaft		38	26	63	102.5	879		
2009.09-2015.08	6MT	F	R	Van FWD CFCA		2032960L	Drive Shaft		38	26	63	102.5	880		
2009.09-2015.08	6MT	F	R	Van FWD CFCA	Date From:2015.05	2033610L	Drive Shaft		38	26	63	102.5	881		
2009.09-2015.08	7DCT	F	L	Van FWD CFCA		2032930L	Drive Shaft		38	37	63	102.5	647		
2009.09-2015.08	7DCT	F	R	Van FWD CFCA	Chassis no. From: 7HC0500001/7HC400000/7HCX00001	2023920L	Drive Shaft		38	37	63	102.5	1026		
2009.09-2015.08	7DCT	F	R	Van FWD CFCA	Chassis no. To: 7HB5500000/7HB4500000/7HBX500000	2033530L	Drive Shaft		38	37	63	102.5	1026		
2010.01-2015.08	6MT	F	L	Bus 4WD CFCA	Date From:2013.07	2033600L	Drive Shaft		38	42	63	102.5	617		
2010.01-2015.08	6MT	F	L	Bus 4WD CFCA		2610840L	Drive Shaft		38	26	63	102.5	616		
2010.01-2015.08	6MT	F	R	Bus 4WD CFCA	Date from:2013.07	2016660L	Drive Shaft		38	26	63	102.5	616		
2010.01-2015.08	6MT	F	R	Bus 4WD CFCA	Date to:2013.06	2610840L	Drive Shaft		38	26	63	102.5	616		
2010.01-2015.08	7DCT	F	L	Bus 4WD CFCA		2032930L	Drive Shaft		38	37	63	102.5	647		
2010.01-2015.08	7DCT	F	R	Bus 4WD CFCA	Chassis no. From: 7HC0500001/7HC400000/7HCX00001, Date From: 2013.07	2016650L	Drive Shaft		38	26	63	102.5	614		
2010.01-2015.08	6MT/7DCT	R	L	Bus 4WD CFCA		2612570L	Drive Shaft		38		59	102	683		
2010.01-2015.08	6MT/7DCT	R	R	Bus 4WD CFCA		2612580L	Drive Shaft		38		59	102	743		
2010.01-2015.08	6MT	F	L	Platform/Chassis 4WD CFCA	Date From:2013.07	2033600L	Drive Shaft		38	42	63	102.5	617		
2010.01-2015.08	6MT	F	R	Platform/Chassis 4WD CFCA	Date from:2013.07	2016660L	Drive Shaft		38	26	63	102.5	616		
2010.01-2015.08	6MT	F	L/R	Platform/Chassis 4WD CFCA	Date to:2013.06	2610840L	Drive Shaft		38	26	63	102.5	616		
2010.01-2015.08	7DCT	F	L	Platform/Chassis 4WD CFCA		2032930L	Drive Shaft		38	37	63	102.5	647		
2010.01-2015.08	7DCT	F	R	Platform/Chassis 4WD CFCA		2016650L	Drive Shaft		38	26	63	102.5	614		
2010.01-2015.08	6MT/7DCT	R	L	Platform/Chassis 4WD CFCA		2612570L	Drive Shaft		38		59	102	683		
2010.01-2015.08	6MT/7DCT	R	R	Platform/Chassis 4WD CFCA		2612580L	Drive Shaft		38		59	102	743		
2010.01-2015.08	6MT	F	L	Van 4WD CFCA	Date From:2013.07	2033600L	Drive Shaft		38	42	63	102.5	617		

YEAR	TRANSM.	F/R	L/R	BODY STYLE & DRIVE TYPE & ENGINE	REMARKS	GSP Ref.	PRODUCT	ABS	Technical Specifications												
									A	B	C	H	L								
VW Transporter																					
2.0 (132 kw)																					
2010.01-2015.08	6MT	F	L	Van 4WD CFCA		2610840L	Drive Shaft		38	26	63	102.5	616								
2010.01-2015.08	6MT	F	R	Van 4WD CFCA	Date from:2013.07	2016660L	Drive Shaft		38	26	63	102.5	616								
2010.01-2015.08	6MT	F	R	Van 4WD CFCA	Date to:2013.06	2610840L	Drive Shaft		38	26	63	102.5	616								
2010.01-2015.08	7DCT	F	L	Van 4WD CFCA		2032930L	Drive Shaft		38	37	63	102.5	647								
2010.01-2015.08	7DCT	F	R	Van 4WD CFCA	8 balls	2016650L	Drive Shaft		38	26	63	102.5	614								
2010.01-2015.08	6MT/7DCT	R	L	Van 4WD CFCA		2612570L	Drive Shaft		38		59	102	683								
2010.01-2015.08	6MT/7DCT	R	R	Van 4WD CFCA		2612580L	Drive Shaft		38		59	102	743								
2015.04-	6MT	F	L	Bus FWD CFCA	Outer teeth of transm.side:42	2033600L	Drive Shaft		38	42	63	102.5	617								
2015.04-	6MT	F	L	Bus FWD CFCA	Date to:2017.01	2610840L	Drive Shaft		38	26	63	102.5	616								
2015.04-	6MT	F	R	Bus FWD CFCA		2033610L	Drive Shaft		38	26	63	102.5	881								
2015.04-	7AT/7DCT	F	L	Bus FWD CFCA		2032930L	Drive Shaft		38	37	63	102.5	647								
2015.04-	7AT/7DCT	F	R	Bus FWD CFCA		2032920L	Drive Shaft		38	37	63	102.5	1026								
2015.04-2019.11	6MT	F	L	Platform/Chassis FWD CFCA	Date To:2017.01	2033600L	Drive Shaft		38	42	63	102.5	617								
2015.04-2019.11	6MT	F	L	Platform/Chassis FWD CFCA	Date to:2017.01	2610840L	Drive Shaft		38	26	63	102.5	616								
2015.04-2019.11	6MT	F	R	Platform/Chassis FWD CFCA	Date To:2017.01	2033610L	Drive Shaft		38	26	63	102.5	881								
2015.04-2019.11	7DCT	F	L	Platform/Chassis FWD CFCA		2032930L	Drive Shaft		38	37	63	102.5	647								
2015.04-2019.11	7DCT	F	R	Platform/Chassis FWD CFCA		2032920L	Drive Shaft		38	37	63	102.5	1026								
2015.04-2019.12	6MT	F	L	Van FWD CFCA	Date To:2017.01	2033600L	Drive Shaft		38	42	63	102.5	617								
2015.04-2019.12	6MT	F	L	Van FWD CFCA	Date to:2017.01	2610840L	Drive Shaft		38	26	63	102.5	616								
2015.04-2019.12	6MT	F	R	Van FWD CFCA	Date To:2017.01	2033610L	Drive Shaft		38	26	63	102.5	881								
2015.04-2019.12	7DCT	F	L	Van FWD CFCA		2032930L	Drive Shaft		38	37	63	102.5	647								
2015.04-2019.12	7DCT	F	R	Van FWD CFCA		2032920L	Drive Shaft		38	37	63	102.5	1026								
2015.06-	6MT	F	L	Bus 4WD CFCA	Outer teeth of transm.side:42	2033600L	Drive Shaft		38	42	63	102.5	617								
2015.06-	6MT	F	L	Bus 4WD CFCA	Date to:2017.01	2610840L	Drive Shaft		38	26	63	102.5	616								
2015.06-	6MT	F	R	Bus 4WD CFCA	Date to:2017.01	2016660L	Drive Shaft		38	26	63	102.5	616								
2015.06-	7AT/7DCT	F	L	Bus 4WD CFCA		2032930L	Drive Shaft		38	37	63	102.5	647								
2015.06-	7DCT	F	R	Bus 4WD CFCA	Date To:2017.01	2016650L	Drive Shaft		38	26	63	102.5	614								
2015.06-	6MT/7DCT	R	L	Bus 4WD CFCA		2612570L	Drive Shaft		38		59	102	683								
2015.06-	6MT/7DCT	F/R	R	Bus 4WD CFCA	Date To:2016.04	2612580L	Drive Shaft		38		59	102	743								
2015.06-2019.11	6MT	F	L	Platform/Chassis 4WD CFCA	Date To:2017.01	2033600L	Drive Shaft		38	42	63	102.5	617								
2015.06-2019.11	6MT	F	L	Platform/Chassis 4WD CFCA	Date to:2017.01	2610840L	Drive Shaft		38	26	63	102.5	616								
2015.06-2019.11	6MT	F	R	Platform/Chassis 4WD CFCA	Date to:2017.01	2016660L	Drive Shaft		38	26	63	102.5	616								
2015.06-2019.11	7DCT	F	L	Platform/Chassis 4WD CFCA		2032930L	Drive Shaft		38	37	63	102.5	647								
2015.06-2019.11	7DCT	F	R	Platform/Chassis 4WD CFCA		2016650L	Drive Shaft		38	26	63	102.5	614								
2015.06-2019.11	6MT/7DCT	R	L	Platform/Chassis 4WD CFCA		2612570L	Drive Shaft		38		59	102	683								
2015.06-2019.11	6MT/7DCT	R	R	Platform/Chassis 4WD CFCA	Date To:2016.04	2612580L	Drive Shaft		38		59	102	743								
2015.06-2019.12	6MT	F	L	Van 4WD CFCA	Date To:2017.01	2033600L	Drive Shaft		38	42	63	102.5	617								
2015.06-2019.12	6MT	F	L	Van 4WD CFCA	Date to:2017.01	2610840L	Drive Shaft		38	26	63	102.5	616								
2015.06-2019.12	6MT	F	R	Van 4WD CFCA	Date to:2017.01	2016660L	Drive Shaft		38	26	63	102.5	616								
2015.06-2019.12	7DCT	F	L	Van 4WD CFCA		2032930L	Drive Shaft		38	37	63	102.5	647								
2015.06-2019.12	7DCT	F	R	Van 4WD CFCA		2016650L	Drive Shaft		38	26	63	102.5	614								
2015.06-2019.12	6MT/7DCT	R	L	Van 4WD CFCA		2612570L	Drive Shaft		38		59	102	683								
2015.06-2019.12	6MT/7DCT	R	R	Van 4WD CFCA	Date To:2016.04	2612580L	Drive Shaft		38		59	102	743								
2.0 (146 kw)																					
2018.08-	7DCT	F	L	Bus 4WD CEXEC	Date To:2020.11	2034970L	Drive Shaft		38	37	63	103	646								
2018.08-	7DCT	R	L	Bus 4WD CEXEC		2612570L	Drive Shaft		38		59	102	683								
2018.08-	7DCT	F	L	Bus FWD CEXEC	Date To:2020.11	2034970L	Drive Shaft		38	37	63	103	646								
2018.08-	7DCT	F	R	Bus FWD CEXEC	For Modelcode:SGB/SGJ	2034960L	Drive Shaft		38	37	63	103	1025								
2018.08-	7DCT	F	L	Van 4WD CEXEC	Date To:2020.11	2034970L	Drive Shaft		38	37	63	103	646								
2018.08-	7DCT	R	L	Van 4WD CEXEC		2612570L	Drive Shaft		38		59	102	683								
2019.08-	7DCT	F	L	Platform/Chassis 4WD CEXEC	Date To:2020.11	2034970L	Drive Shaft		38	37	63	103	646								
2019.08-	7DCT	R	L	Platform/Chassis 4WD CEXEC		2612570L	Drive Shaft		38		59	102	683								
2019.08-	7DCT	F	L	Platform/Chassis FWD CEXEC	Date To:2020.11	2034970L	Drive Shaft		38	37	63	103	646								
2019.08-	7DCT	F	R	Van FWD CEXEC	Date To:2020.11	2034970L	Drive Shaft		38	37	63	103	646								
2.0 (150 kw)																					
2011.05-2015.08	7DCT	F	L	Bus 4WD CJK		2032930L	Drive Shaft		38	37	63	102.5	647								
2011.05-2015.08	7DCT	F	R	Bus 4WD CJK		2016650L	Drive Shaft		38	26	63	102.5	614								
2011.05-2015.08	7DCT	R	L	Bus 4WD CJK		2612570L	Drive Shaft		38		59	102	683								
2011.05-2015.08	7DCT	R	R	Bus 4WD CJK		2612580L	Drive Shaft		38		59	102	743								
2011.05-2015.08	6MT	F	L	Bus FWD CJK	Date From:2013.07	2033600L	Drive Shaft		38	42	63	102.5	617								
2011.05-2015.08	6MT	F	L	Bus FWD CJK	Date to:2013.06	2610840L	Drive Shaft		38	26	63	102.5	616								
2011.05-2015.08	6MT	F	R	Bus FWD CJK	Date From:2013.07,Date To:2015.04	2023610L	Drive Shaft		38	26	63	102.5	879								
2011.05-2015.08	6MT	F	R	Bus FWD CJK	Date To:2013.06	2032960L	Drive Shaft		38	26	63	102.5	880								
2011.05-2015.08	6MT	F	R	Bus FWD CJK	Date From:2015.05	2033610L	Drive Shaft		38	26	63	102.5	881								
2011.05-2015.08	7DCT	F	L	Bus FWD CJK		2032930L	Drive Shaft		38	37	63	102.5	647								
2011.05-2015.08	7DCT	F	R	Bus FWD CJK	Chassis no. from:7HC000001/7HC400001/7HCX00001	2032920L	Drive Shaft		38	37	63	102.5	1026								
2011.05-2015.08	7DCT	F	R	Bus FWD CJK	Chassis no. for:7HB500000/7HB400000/7HBX500000	2033530L	Drive Shaft		38	37	63	102.5	1026								

 YEAR	TRANSM.	F/R	L/R	BODY STYLE & DRIVE TYPE & ENGINE	REMARKS	GSP Ref.	 PRODUCT	 ABS	Technical Specifications					
									A	B	C	H	L	
VW Transporter														
2.0 (150 kw)														
2011.05-2015.08	6MT	F	L	Van FWD CJK	Date From:2013.07	2033600L	Drive Shaft		38	42	63	102.5	617	
2011.05-2015.08	6MT	F	L	Van FWD CJK	Date to:2013.06	2610840L	Drive Shaft		38	26	63	102.5	616	
2011.05-2015.08	6MT	F	R	Van FWD CJK	Date From:2013.07,Date To:2015.04	2023610L	Drive Shaft		38	26	63	102.5	879	
2011.05-2015.08	6MT	F	R	Van FWD CJK	Date To:2013.06	2032960L	Drive Shaft		38	26	63	102.5	880	
2011.05-2015.08	6MT	F	R	Van FWD CJK	Date From:2015.05	2033610L	Drive Shaft		38	26	63	102.5	881	
2011.05-2015.08	7DCT	F	L	Van FWD CJK		2032930L	Drive Shaft		38	37	63	102.5	647	
2011.05-2015.08	7DCT	F	R	Van FWD CJK		2023920L	Drive Shaft		38	37	63	102.5	1026	
2011.07-2015.08	7DCT	F	L	Van 4WD CJK		2032930L	Drive Shaft		38	37	63	102.5	647	
2011.07-2015.08	7DCT	F	R	Van 4WD CJK		2016650L	Drive Shaft		38	26	63	102.5	614	
2011.07-2015.08	7DCT	R	L	Van 4WD CJK		2612570L	Drive Shaft		38		59	102	683	
2011.07-2015.08	7DCT	R	R	Van 4WD CJK		2612580L	Drive Shaft		38		59	102	743	
2015.04-	7AT	F	L	Bus FWD CJK		2032930L	Drive Shaft		38	37	63	102.5	647	
2015.04-	7AT	F	R	Bus FWD CJK		2023920L	Drive Shaft		38	37	63	102.5	1026	
2015.04-2019.07	7AT	F	L	Van FWD CJK		2032930L	Drive Shaft		38	37	63	102.5	647	
2015.04-2019.07	7AT	F	R	Van FWD CJK		2023920L	Drive Shaft		38	37	63	102.5	1026	
2015.06-	7AT	F	L	Bus 4WD CJK		2032930L	Drive Shaft		38	37	63	102.5	647	
2015.06-	7AT	F	R	Bus 4WD CJK		2016650L	Drive Shaft		38	26	63	102.5	614	
2015.06-	7DCT	R	L	Bus 4WD CJK		2612570L	Drive Shaft		38		59	102	683	
2015.06-	7DCT	R	R	Bus 4WD CJK		2612580L	Drive Shaft		38		59	102	743	
2015.06-	7AT	F	L	Bus FWD CJK		2032930L	Drive Shaft		38	37	63	102.5	647	
2015.06-	7AT	F	R	Bus FWD CJK		2023920L	Drive Shaft		38	37	63	102.5	1026	
2015.06-	7AT	F	L	Van FWD CJK		2032930L	Drive Shaft		38	37	63	102.5	647	
2015.06-	7AT	F	R	Van FWD CJK		2023920L	Drive Shaft		38	37	63	102.5	1026	
2015.06-	7AT	F	L	Bus 4WD CJK		2032930L	Drive Shaft		38	37	63	102.5	647	
2015.06-	7AT	F	R	Bus 4WD CJK		2016650L	Drive Shaft		38	26	63	102.5	614	
2015.06-	7DCT	R	L	Bus 4WD CJK		2612570L	Drive Shaft		38		59	102	683	
2015.06-	7DCT	R	R	Bus 4WD CJK	Date To:2016.04	2612580L	Drive Shaft		38		59	102	743	
2015.06-	7DCT	F	L	Bus 4WD CXEB/DMZA	Date From:2017.01,Date To:2020.11	2034970L	Drive Shaft		38	37	63	103	646	
2015.06-	6MT/7DCT	R	L	Bus 4WD CXEB/DMZA		2612570L	Drive Shaft		38		59	102	683	
2015.06-	6MT/7DCT	R	R	Bus 4WD CXEB/DMZA	Date To:2016.04	2612580L	Drive Shaft		38		59	102	743	
2015.06-	7DCT	F	L	Bus FWD CXEB/DMZA	Date From:2017.02,Date To:2020.11	2034970L	Drive Shaft		38	37	63	103	646	
2015.06-	7DCT	F	R	Bus FWD CXEB/DMZA	For Modelcode:SGB/SGJ	2034960L	Drive Shaft		38	37	63	103	1025	
2015.06-	7DCT	F	L	Van 4WD CXEB/DMZA	Date From:2017.01,Date To:2020.11	2034970L	Drive Shaft		38	37	63	103	646	
2015.06-	6MT/7DCT	R	L	Van 4WD CXEB/DMZA		2612570L	Drive Shaft		38		59	102	683	
2015.06-	6MT/7DCT	R	R	Van 4WD CXEB/DMZA	Date To:2016.04	2612580L	Drive Shaft		38		59	102	743	
2015.06-	7DCT	F	L	Van FWD CXEB/DMZA	Date From:2017.02,Date To:2020.11	2034970L	Drive Shaft		38	37	63	103	646	
2015.06-	7DCT	F	R	Van FWD CXEB/DMZA	For Modelcode:SGA/SGH	2034960L	Drive Shaft		38	37	63	103	1025	
2015.06-2019.07	7AT	F	L	Van 4WD CJK		2032930L	Drive Shaft		38	37	63	102.5	647	
2015.06-2019.07	7AT	F	R	Van 4WD CJK		2016650L	Drive Shaft		38	26	63	102.5	614	
2015.06-2019.07	7DCT	R	L	Van 4WD CJK		2612570L	Drive Shaft		38		59	102	683	
2015.06-2019.07	7DCT	R	R	Van 4WD CJK	Date To:2016.04	2612580L	Drive Shaft		38		59	102	743	
2016.05-2019.11	7DCT	F	L	Platform/Chassis 4WD CXEB	Date from:2017.02	2034970L	Drive Shaft		38	37	63	103	646	
2016.05-2019.11	7DCT/6MT	R	L	Platform/Chassis 4WD CXEB		2612570L	Drive Shaft		38		59	102	683	
2016.05-2019.11	7DCT	F	L	Platform/Chassis FWD CXEB	Date from:2017.02	2034970L	Drive Shaft		38	37	63	103	646	
2016.05-2019.11	7DCT	F	R	Platform/Chassis FWD CXEB		2034960L	Drive Shaft		38	37	63	103	1025	
2.5 (96 kw)														
2003.04-2009.11	6MT	F	L	Platform/Chassis FWD AXD/BNZ		2610840L	Drive Shaft		38	26	63	102.5	616	
2003.04-2009.11	6MT	F	L	Van FWD AXD/BNZ		2610840L	Drive Shaft		38	26	63	102.5	616	
2004.07-2009.11	6MT	F	L	Platform/Chassis 4WD AXD/BNZ		2610840L	Drive Shaft		38	26	63	102.5	616	
2004.07-2009.11	6AT/6MT	R	L	Platform/Chassis 4WD AXD/BNZ		2612570L	Drive Shaft		38		59	102	683	
2004.07-2009.11	6AT/6MT	R	R	Platform/Chassis 4WD AXD/BNZ		2612580L	Drive Shaft		38		59	102	743	
2004.07-2009.11	6MT	F	L	Van 4WD AXD/BNZ		2610840L	Drive Shaft		38	26	63	102.5	616	
2004.07-2009.11	6MT	R	L	Van 4WD AXD/BNZ		2612570L	Drive Shaft		38		59	102	683	
2004.07-2009.11	6MT	R	R	Van 4WD AXD/BNZ		2612580L	Drive Shaft		38		59	102	743	
2.5 (128 kw)														
2003.05-2009.11	6MT	F	L	Platform/Chassis FWD AXE/BPC		2610840L	Drive Shaft		38	26	63	102.5	616	
2003.05-2009.11	6MT	F	L	Van FWD AXE/BPC		2610840L	Drive Shaft		38	26	63	102.5	616	
2003.10-2009.11	6MT	F	L	Platform/Chassis 4WD AXE/BPC		2610840L	Drive Shaft		38	26	63	102.5	616	
2003.10-2009.11	6AT/6MT	R	L	Platform/Chassis 4WD AXE/BPC		2612570L	Drive Shaft		38		59	102	683	
2003.10-2009.11	6AT/6MT	R	R	Platform/Chassis 4WD AXE/BPC		2612580L	Drive Shaft		38		59	102	743	
2004.07-2009.11	6MT	F	L	Van 4WD AXE/BPC		2610840L	Drive Shaft		38	26	63	102.5	616	
2004.07-2009.11	6MT	R	L	Van 4WD AXE/BPC		2612570L	Drive Shaft		38		59	102	683	
2004.07-2009.11	6MT	R	R	Van 4WD AXE/BPC		2612580L	Drive Shaft		38		59	102	743	
3.2 (173 kw)														
2003.11-2009.11	6MT	R	L	Platform/Chassis 4WD BDL		2612570L	Drive Shaft		38		59	102	683	
2003.11-2009.11	6MT	R	R	Platform/Chassis 4WD BDL		2612580L	Drive Shaft		38		59	102	743	
2004.07-2009.11	6AT/6MT	R	L	Van 4WD BKK/CFLA		2612570L	Drive Shaft		38		59	102	683	
2004.07-2009.11	6AT/6MT	R	R	Van 4WD BKK/CFLA		2612580L	Drive Shaft		38		59	102	743	
Transporter Shuttle														
1.9 (62 kw)	2006.01-2009.11	5MT	F	L	Bus FWD BRR	6 balls	2611050L	Drive Shaft		38		63	102.5	645
1.9 (63 kw)	2003.04-2009.11	5MT	F	L	Bus FWD AXC	6 balls	2611050L	Drive Shaft		38		63	102.5	645
1.9 (75 kw)	2005.06-2009.11	5MT	F	L	Bus FWD BRS	6 balls	2611050L	Drive Shaft		38		63	102.5	645
1.9 (77 kw)	2003.04-2009.11	5MT	F	L	Bus FWD AXB	6 balls	2611050L	Drive Shaft		38		63	102.5	645
2.0 (62 kw)														
	2009.09-2015.08	5MT	F	L	Bus FWD CAAA	6 balls	2611050L	Drive Shaft		38		63	102.5	645
	2009.09-2015.08	5MT	F	R	Bus FWD CAAA		2032610L	Drive Shaft		38	26	63	102.5	857
2.0 (75 kw)														
	2009.09-2015.08	5MT	F	L	Bus FWD CAAB	6 balls	2611050L	Drive Shaft		38		63	102.5	645

 YEAR	TRANSM.	F/R	L/R	BODY STYLE & DRIVE TYPE & ENGINE	REMARKS	GSP Ref.	 PRODUCT ABS	Technical Specifications						
								A	B	C	H	L		
VW														
Transporter Shuttle														
2.0 (75 kw)	2009.09-2015.08	5MT	F	R	Bus FWD CAAB		2032610L	Drive Shaft	38	26	63	102.5	857	
2.0 (84 kw)	2011.05-2015.08	5MT	F	L	Bus FWD CAAD	6 balls	2611050L	Drive Shaft	38		63	102.5	645	
	2011.05-2015.08	5MT	F	R	Bus FWD CAAD		2032610L	Drive Shaft	38	26	63	102.5	857	
2.0 (85 kw)	2003.11-2009.11	5MT	F	L	Bus FWD AXA	6 balls	2611050L	Drive Shaft	38		63	102.5	645	
2.0 (103 kw)	2009.09-2015.08	6MT	F	L	Bus FWD CAAC/CCHA	Date From:2013.07	2033600L	Drive Shaft	38	42	63	102.5	617	
	2009.09-2015.08	6MT	F	L	Bus FWD CAAC/CCHA	Date to:2013.06	2610840L	Drive Shaft	38	26	63	102.5	616	
	2009.09-2015.08	6MT	F	R	Bus FWD CAAC/CCHA	Date From:2013.07,Date To:2015.04	2032610L	Drive Shaft	38	26	63	102.5	879	
	2009.09-2015.08	6MT	F	R	Bus FWD CAAC/CCHA		2032960L	Drive Shaft	38	26	63	102.5	880	
	2009.09-2015.08	6MT	F	R	Bus FWD CAAC/CCHA	Date From:2015.05	2033610L	Drive Shaft	38	26	63	102.5	881	
	2009.09-2015.08	7DCT	F	L	Bus FWD CAAC/CCHA		2032930L	Drive Shaft	38	37	63	102.5	647	
	2009.09-2015.08	7DCT	F	R	Bus FWD CAAC/CCHA	Chassis no. From:7HC0000001/7HC4000001/7HCX000001	2032920L	Drive Shaft	38	37	63	102.5	1026	
	2009.09-2015.08	7DCT	F	R	Bus FWD CAAC/CCHA	Chassis no. To:7H8S000000/7H8H000000/7H8X000000	2033530L	Drive Shaft	38	37	63	102.5	1026	
	2009.10-2015.08	6MT	F	L	Bus 4WD CAAC/CCHA	Date From:2013.07	2033600L	Drive Shaft	38	42	63	102.5	617	
	2009.10-2015.08	6MT	F	R	Bus 4WD CAAC/CCHA	Date from:2013.07	2016660L	Drive Shaft	38	26	63	102.5	616	
	2009.10-2015.08	6MT	R	L	Bus 4WD CAAC/CCHA		2612570L	Drive Shaft	38		59	102	683	
	2009.10-2015.08	6MT	R	R	Bus 4WD CAAC/CCHA		2612580L	Drive Shaft	38		59	102	743	
	2.0 (132 kw)	2011.05-2015.08	6MT	F	L	Bus 4WD CFCA	Date From:2013.07	2033600L	Drive Shaft	38	42	63	102.5	617
2011.05-2015.08		7DCT	F	L	Bus 4WD CFCA		2032930L	Drive Shaft	38	37	63	102.5	647	
2011.05-2015.08		7DCT	F	R	Bus 4WD CFCA	Date From:2013.07	2016650L	Drive Shaft	38	26	63	102.5	614	
2011.05-2015.08		7DCT	R	L	Bus 4WD CFCA		2612570L	Drive Shaft	38		59	102	683	
2011.05-2015.08		7DCT	R	R	Bus 4WD CFCA		2612580L	Drive Shaft	38		59	102	743	
2011.05-2015.08		6MT	F	L	Bus FWD CFCA	Date From:2013.07	2033600L	Drive Shaft	38	42	63	102.5	617	
2011.05-2015.08		6MT	F	L	Bus FWD CFCA	Date to:2013.06	2610840L	Drive Shaft	38	26	63	102.5	616	
2011.05-2015.08		6MT	F	R	Bus FWD CFCA	Date From:2013.07,Date To:2015.04	2023610L	Drive Shaft	38	26	63	102.5	879	
2011.05-2015.08		6MT	F	R	Bus FWD CFCA	Date To:2013.06	2032960L	Drive Shaft	38	26	63	102.5	880	
2011.05-2015.08		6MT	F	R	Bus FWD CFCA	Date From:2015.05	2033610L	Drive Shaft	38	26	63	102.5	881	
2011.05-2015.08		7DCT	F	L	Bus FWD CFCA		2032930L	Drive Shaft	38	37	63	102.5	647	
2011.05-2015.08		7DCT	F	R	Bus FWD CFCA	Chassis no. From:7HC0000001/7HC4000001/7HCX000001	2032920L	Drive Shaft	38	37	63	102.5	1026	
2011.05-2015.08		7DCT	F	R	Bus FWD CFCA	Chassis no. To:7H8S000000/7H8H000000/7H8X000000	2033530L	Drive Shaft	38	37	63	102.5	1026	
2.5 (96 kw)		2003.04-2009.11	6MT	F	L	Bus FWD AXD/BNZ		2610840L	Drive Shaft	38	26	63	102.5	616
		2004.07-2009.11	6MT	F	L	Bus 4WD AXD		2610840L	Drive Shaft	38	26	63	102.5	616
	2004.07-2009.11	6MT	R	L	Bus 4WD AXD		2612570L	Drive Shaft	38		59	102	683	
	2004.07-2009.11	6MT	R	R	Bus 4WD AXD		2612580L	Drive Shaft	38		59	102	743	
2.5 (120 kw)	2003.11-2009.11	6MT	F	L	Bus FWD BLJ		2610840L	Drive Shaft	38	26	63	102.5	616	
2.5 (128 kw)	2004.07-2009.11	6MT	F	L	Bus 4WD AXE		2610840L	Drive Shaft	38	26	63	102.5	616	
	2004.07-2009.11	6MT	R	L	Bus 4WD AXE		2612570L	Drive Shaft	38		59	102	683	
	2004.07-2009.11	6MT	R	R	Bus 4WD AXE		2612580L	Drive Shaft	38		59	102	743	
	2004.07-2009.11	6MT	F	L	Bus FWD AXE/BPC		2033600L	Drive Shaft	38	42	63	102.5	617	
	2004.07-2009.11	6MT	F	L	Bus FWD AXE/BPC		2610840L	Drive Shaft	38	26	63	102.5	616	
3.2 (173 kw)	2003.11-2009.12	6MT	R	L	Bus 4WD BKK/CFLA		2612570L	Drive Shaft	38		59	102	683	
	2003.11-2009.12	6MT	R	R	Bus 4WD BKK/CFLA		2612580L	Drive Shaft	38		59	102	743	
VW (FAW)														
Magotan														
1.8 (118 kw)	2007.06-2011.07	5MT	F	R	Saloon FWD BYJ		2613410L	Drive Shaft	36		59.5	40.5	806	
	2011.07-2015.12	AT		R	Saloon FWD CEAA		2613410L	Drive Shaft	36		59.5	40.5	806	
2.0 (147 kw)	2007.12-2011.07	AT		R	Saloon FWD CBLA		2016530L	Drive Shaft	36		59.5	40.5	785	
	2011.07-2015.12	AT		R	Saloon FWD CGMA		2016530L	Drive Shaft	36		59.5	40.5	785	

COMPETITOR	GSP Ref.	COMPETITOR	GSP Ref.	COMPETITOR	GSP Ref.	COMPETITOR	GSP Ref.
LÖBRO		305621	235085OL	24479	203313OL	7P5501201C	201106OL
		304544	235086OL	25484	203313OL	95833202420	201106OL
306299	201110OL	305441	235086OL	24795	203316OL	95833202421	201106OL
306629	201265OL	304889	241262OL	36190	203371OL	31607607937	201110OL
305727	201385OL	304751	254011OL	25172	203373OL	31607622913	201110OL
305726	201387OL	304747	254013OL	36122	203380OL	31607629881	201110OL
305068	201530OL	305531	254013OL	36674	203742OL	31608631747	201110OL
306465	201531OL	304750	261042OL	25535	205043OL	5N0407763F	201265OL
305945	201581OL	304771	261042OL	25534	205052OL	5N0407763FX	201265OL
306469	201665OL	304501	261084OL	36093	205070OL	5N0407763J	201265OL
305948	201681OL	304506	261084OL	25789	205112OL	5N0407763JX	201265OL
305949	201716OL	304769	261094OL	25795	205112OL	5N0407763L	201265OL
306358	202052OL	304753	261096OL	25790	205113OL	5Q0407271CR	201265OL
306359	202053OL	305785	261100OL	25787	205114OL	5Q0407763EX	201265OL
306360	202058OL	304499	261105OL	25788	205115OL	36000509	201371OL
306361	202059OL	305652	261105OL	25802	205117OL	36000937	201371OL
306947	202060OL	305769	261147OL	25804	205117OL	36001216	201371OL
306819	202077OL	304763	261201OL	24866	205119OL	31325110	201375OL
306723	202548OL	304774	261211OL	25803	205121OL	36010058	201375OL
305944	202730OL	304850	261236OL	25805	205121OL	31325701	201377OL
306520	203207OL	304528	261257OL	25831	205121OL	36010064	201377OL
306519	203208OL	305295	261257OL	36121	205123OL	31325111	201378OL
305504	203261OL	304529	261258OL	24899	205134OL	31437522	201378OL
304767	203266OL	305296	261258OL	25067	205134OL	36010059	201378OL
305770	203269OL	306791	261285OL	25641	205135OL	36010216	201378OL
304923	203273OL	305767	261296OL	25070	205149OL	31325702	201379OL
306001	203293OL	305768	261296OL	25830	218334OL	31437523	201379OL
304746	203294OL	306539	261338OL	36711	218334OL	36010217	201379OL
304758	203294OL	305786	261341OL	36712	218334OL	36011305	201379OL
304762	203294OL	305762	261347OL	36545	218445OL	30783068	201385OL
304748	203295OL	305771	261347OL	24964	221045OL	31325573	201385OL
304764	203295OL	306630	261347OL	36194	235067OL	31367536	201385OL
305659	203295OL	SPIDAN		36671	235067OL	36001019	201385OL
306978	203295OL	36450	201265OL	24198	235085OL	36001813	201385OL
305510	203296OL	25533	201385OL	25398	235085OL	36002544	201385OL
306004	203296OL	25532	201387OL	24197	235086OL	36012415	201385OL
304752	203313OL	24796	201530OL	25218	235086OL	50463394	201385OL
305707	203313OL	36375	201530OL	24618	241262OL	50643687	201385OL
305067	203316OL	36286	201531OL	24478	254011OL	8G9N3B437AA	201385OL
306369	203371OL	25751	201581OL	24474	254013OL	P31367536	201385OL
305395	203373OL	36290	201665OL	25308	254013OL	30783071	201387OL
306301	203380OL	25754	201681OL	24477	261042OL	31272545	201387OL
306853	203742OL	25755	201716OL	24498	261042OL	31367560	201387OL
305729	205043OL	36179	202052OL	24154	261084OL	36001183	201387OL
305728	205052OL	36180	202053OL	24159	261084OL	36002546	201387OL
306272	205070OL	36181	202058OL	24496	261094OL	36012419	201387OL
305983	205112OL	36182	202059OL	24480	261096OL	50463398	201387OL
305989	205112OL	36768	202060OL	25592	261100OL	50558699	201387OL
305984	205113OL	36640	202077OL	24152	261105OL	8G9N3B436AA	201387OL
305981	205114OL	36544	202548OL	25429	261105OL	8G9N3B436AB	201387OL
305982	205115OL	25750	202730OL	25576	261147OL	P31367560	201387OL
305996	205117OL	36341	203207OL	24490	261201OL	30783072	201388OL
305125	205119OL	36340	203208OL	24501	261211OL	31272546	201388OL
305997	205121OL	25281	203261OL	24577	261236OL	31367563	201388OL
306025	205121OL	24494	203266OL	24181	261257OL	36012420	201388OL
306300	205123OL	25577	203269OL	25071	261257OL	30783076	201389OL
305158	205134OL	24652	203273OL	24182	261258OL	36001814	201389OL
305291	205134OL	25807	203293OL	25072	261258OL	36012421	201389OL
305835	205135OL	24473	203294OL	36612	261285OL	36051054	201404OL
305294	205149OL	24485	203294OL	25574	261296OL	2423300200	201470OL
306024	218334OL	24489	203294OL	25575	261296OL	2463301701	201470OL
306890	218334OL	24475	203295OL	25593	261341OL	2463301901	201470OL
306891	218334OL	24491	203295OL	25568	261347OL	2463302101	201470OL
306724	218445OL	25436	203295OL	25578	261347OL	2463303000	201470OL
305213	221045OL	36799	203295OL	36451	261347OL	2463303200	201470OL
306373	235067OL	25287	203296OL	OE		2463309300	201470OL
306850	235067OL	25810	203296OL	7P5501201A	201106OL	2463309500	201470OL
304545	235085OL					A2423300200	201470OL

COMPETITOR	GSP Ref.	COMPETITOR	GSP Ref.	COMPETITOR	GSP Ref.	COMPETITOR	GSP Ref.
OE		3Q0407272G	201889OL	3Q0407761QV	202351OL	31437621	203207OL
		8J0407762A	201889OL	3Q0407761QX	202351OL	32240323	203207OL
A2463301701	201470OL	1K0407271DT	201896OL	3Q0407761TX	202351OL	32336203	203207OL
A2463301901	201470OL	3Q0407271	201896OL	5QF407271K	202351OL	36003640	203207OL
A2463302101	201470OL	3Q0407271A	201896OL	5QF407761AX	202351OL	36010127	203207OL
A2463303000	201470OL	3Q0407271AB	201896OL	5C0407271Q	202356OL	36010221	203207OL
A2463303200	201470OL	3Q0407271AE	201896OL	7E0407272AC	202361OL	36011782	203207OL
A2463309300	201470OL	3Q0407761GX	201896OL	8W0501203D	202363OL	36012827	203207OL
A2463309500	201470OL	3Q0407761HX	201896OL	31602380426	202380OL	50794568	203207OL
4G0407271D	201530OL	3Q0407761JX	201896OL	31607639432	202380OL	31325852	203208OL
4G0407271F	201530OL	5C0407271AA	201896OL	31608611936	202380OL	36003638	203208OL
4G0407451BV	201530OL	5C0407271S	201896OL	31608611927	202381OL	36010126	203208OL
4G0407451BX	201530OL	31607597693	202052OL	31608643361	202381OL	36010571	203208OL
4H0407451AV	201530OL	7597693	202052OL	31602380427	202382OL	36011773	203208OL
4H0407451AX	201530OL	7638777	202052OL	31607639433	202382OL	50694325	203208OL
4H0407451BX	201530OL	31607597694	202053OL	31608611935	202382OL	2053300003	203231OL
8R0407271A	201530OL	31607638776	202053OL	31608643377	202382OL	2053303806	203231OL
8R0407271C	201530OL	7597694	202053OL	31608643385	202382OL	2053305306	203231OL
8R0407271CX	201530OL	7638776	202053OL	7E0407276P	202392OL	2053308406	203231OL
95B407271C	201530OL	31607605511	202058OL	7E0407454CX	202392OL	A2053300003	203231OL
95B407271E	201530OL	7591681	202058OL	7E0407454NX	202392OL	A2053303806	203231OL
4M0407271	201531OL	7594681	202058OL	7E0407761C	202392OL	A2053305306	203231OL
4M0407271D	201531OL	7606299	202058OL	7LA407272C	202392OL	A2053308406	203231OL
31607593043	201581OL	31607605512	202059OL	3910100Q6K	202548OL	7E0407272AB	203261OL
31607618681	201581OL	7591682	202059OL	3910100Q7C	202548OL	7E0407272AH	203261OL
7593043	201581OL	7591982	202059OL	391013827R	202548OL	7E0407272AP	203261OL
7618681	201581OL	7606300	202059OL	391018696R	202548OL	7E0407272N	203261OL
AY759304304	201581OL	31607619657	202060OL	4422671	202548OL	7E0407272NV	203261OL
1K0407272JR	201653OL	31608675013	202060OL	6000618517	202548OL	7E0407272NX	203261OL
1K0407272KJ	201653OL	7598027	202060OL	8201189892	202548OL	7E0407272S	203261OL
1K0407272PK	201653OL	31607619658	202061OL	93453896	202548OL	7E0407276K	203261OL
1K0407272RD	201653OL	31608675014	202061OL	31608611929	202631OL	7E0407452CX	203261OL
1K0407272RL	201653OL	7598028	202061OL	31608643363	202631OL	7E0407452GX	203261OL
1K0407272RP	201653OL	8W0407271	202074OL	31608611930	202632OL	7E0407452MX	203261OL
1K0407272SB	201653OL	8W0407271B	202074OL	31608643364	202632OL	7E0407452TX	203261OL
1K0407272TK	201653OL	8W0407271D	202074OL	31608651276	202632OL	1K0407272CR	203266OL
1K0407762AX	201653OL	8W0407271A	202075OL	31608611938	202633OL	1K0407272JF	203266OL
1K0407764AX	201653OL	8W0407271E	202075OL	31607593039	202730OL	1K0407452TX	203266OL
1K0407764FX	201653OL	8W0407271G	202075OL	31607606027	202730OL	1K0407454MX	203266OL
1K0407764MX	201653OL	8WD407271B	202075OL	7593039	202730OL	5Q0407272EQ	203266OL
5Q407272DQ	201653OL	8R0407271G	202077OL	7606027	202730OL	5N0407764H	203269OL
7E0407272AL	201665OL	95B407271	202077OL	2234732	202855OL	5N0407764HX	203269OL
7E0407272BG	201665OL	95B407271A	202077OL	2253907	202855OL	8K0407271AK	203273OL
7E0407452SX	201665OL	95B407271B	202077OL	2346540	202855OL	8K0407271D	203273OL
7E0407454P	201665OL	95B407271D	202077OL	JX673B437HAD	202855OL	8K0407271E	203273OL
7E0407454PX	201665OL	95B407271F	202077OL	JX673B437HAE	202855OL	8K0407271F	203273OL
7E0407272AK	201666OL	95B407271H	202077OL	2234734	202856OL	8K0407271Q	203273OL
7E0407452PX	201666OL	31608611928	202174OL	2253906	202856OL	8K0407451AV	203273OL
31607593044	201681OL	31608643362	202174OL	2346538	202856OL	8K0407451AX	203273OL
31607618680	201681OL	8643362	202174OL	JX673B436HAC	202856OL	8K0407451DX	203273OL
7593044	201681OL	33207646867	202176OL	JX673B436HAD	202856OL	8K0407451KX	203273OL
7618680	201681OL	31608611939	202177OL	JX673B436HAE	202856OL	8KD407271A	203273OL
103061500A	201698OL	31608643375	202177OL	LR024758	202992OL	7E0407271AB	203293OL
103061500B	201698OL	8643375	202177OL	42310TLAA01	203102OL	7E0407271G	203293OL
103061500D	201698OL	8W0407271F	202256OL	42311TLAA01	203103OL	7E0407271L	203293OL
100771900C	201699OL	CPLA4K138AA	202345OL	4473305000	203138OL	7E0407271P	203293OL
100771901A	201699OL	CPLA4K138AB	202345OL	4473305400	203138OL	7E0407451AX	203293OL
102711100B	201700OL	LR034534	202345OL	A4473305000	203138OL	7E0407451EX	203293OL
103061600A	201701OL	LR053789	202345OL	A4473305400	203138OL	7E0407451NX	203293OL
103061600B	201701OL	CPLA4K139CB	202346OL	4473301900	203139OL	7LA407271E	203293OL
103061600D	201701OL	LR034536	202346OL	4473304900	203139OL	1K0407271AT	203294OL
102711500B	201702OL	LR053791	202346OL	4473305300	203139OL	1K0407271CP	203294OL
31607593046	201716OL	LR073346	202346OL	A4473301900	203139OL	1K0407271DR	203294OL
31607606026	201716OL	3Q0407271AG	202351OL	A4473304900	203139OL	1K0407271HN	203294OL
31607618682	201716OL	3Q0407271AH	202351OL	A4473305300	203139OL	1K0407451CX	203294OL
7593046	201716OL	3Q0407271AP	202351OL	BJ323B436CA	203177OL	1K0407451FX	203294OL
7618682	201716OL	3Q0407761PV	202351OL	LR024754	203177OL	1K0407451KX	203294OL
3Q0407272AG	201889OL	3Q0407761PX	202351OL	31325854	203207OL	1K0407763EX	203294OL

COMPETITOR	GSP Ref.	COMPETITOR	GSP Ref.	COMPETITOR	GSP Ref.	COMPETITOR	GSP Ref.
OE		5Q0407272E	203313OL	3Q0407761MX	203381OL	A2533509106	203743OL
		5Q0407272F	203313OL	3Q0407761SX	203381OL	2533301300	203782OL
1Q0407271A	203294OL	5Q0407762FX	203313OL	561407271R	203381OL	2533302000	203782OL
3C0407271AE	203294OL	5Q0407762JX	203313OL	4G0407271G	203382OL	A2533301300	203782OL
5Q0407271CC	203294OL	5Q0407762KX	203313OL	4H0407271K	203382OL	A2533302000	203782OL
5Q0407271CD	203294OL	7N0407764A	203313OL	4N0407271F	203382OL	2533305501	203784OL
5Q0407761GX	203294OL	7N0407764AX	203313OL	31325101	203405OL	A2533305501	203784OL
5Q0407761RX	203294OL	7N0407764C	203313OL	31367535	203405OL	2043501910	203792OL
JZW407271CX	203294OL	7N0407764CX	203313OL	36001403	203405OL	2043508223	203792OL
JZW407271DX	203294OL	7N0407764N	203313OL	36012414	203405OL	A2043501910	203792OL
JZW407271EX	203294OL	7N0407764NX	203313OL	30783070	203406OL	A2043508223	203792OL
1K0407271BJ	203295OL	7N0407764Q	203313OL	31272542	203406OL	2043504010	203793OL
1K0407271BN	203295OL	7N0407764QX	203313OL	31367556	203406OL	A2043504010	203793OL
1K0407271EE	203295OL	8R0407271	203316OL	36001182	203406OL	2053503102	203794OL
1K0407271ES	203295OL	8R0407271B	203316OL	36002545	203406OL	2053504019	203794OL
1K0407271HG	203295OL	8R0407271BX	203316OL	36012418	203406OL	2053508602	203794OL
1K0407271HM	203295OL	7E0407272AE	203353OL	7E0407276Q	203496OL	A2053503102	203794OL
1K0407271LJ	203295OL	7E0407272AQ	203353OL	7E0407454FX	203496OL	A2053504019	203794OL
1K0407271MC	203295OL	7E0407272BC	203353OL	7E0407454SX	203496OL	A2053508602	203794OL
1K0407271NP	203295OL	7E0407272C	203353OL	7E0407761D	203496OL	33207641212	203925OL
1K0407271NQ	203295OL	7E0407272Q	203353OL	7E0407274H	203497OL	2N0407272H	203935OL
1K0407451DX	203295OL	7E0407452AX	203353OL	3Q0407272BJ	203613OL	2N0407272K	203935OL
1K0407451TX	203295OL	7E0407452JX	203353OL	3Q0407272CE	203613OL	2N0407272M	203935OL
1K0407453BX	203295OL	7E0407452RX	203353OL	3Q0407764BX	203613OL	2N0407272R	203935OL
1K0407453DX	203295OL	1K0407272QF	203354OL	3Q0407764CX	203613OL	2N0407272L	203936OL
1K0407453JX	203295OL	1K0407764EX	203354OL	31367192	203640OL	2N0407272N	203936OL
1K0407761HX	203295OL	1Q0407272A	203354OL	36010164	203640OL	2N0407271H	203937OL
1K0407761TX	203295OL	3AA407272A	203354OL	2533307900	203655OL	2N0407271L	203937OL
3C0407451FX	203295OL	3AA407452AX	203354OL	A2533307900	203655OL	2N0407271F	203938OL
5N0407761F	203295OL	5Q0407272BT	203354OL	31367193	203661OL	2N0407271J	203938OL
5N0407761FX	203295OL	5Q0407272J	203354OL	36010165	203661OL	2N0407271K	203938OL
5N0407763D	203295OL	5Q0407762AX	203354OL	2053303906	203679OL	2N0407271N	203938OL
5N0407763DX	203295OL	5Q0407762HX	203354OL	2053304406	203679OL	2N0407451AX	203938OL
5N0407763G	203295OL	7N0407764D	203354OL	2053308306	203679OL	33207641213	203968OL
5N0407763GX	203295OL	7N0407764R	203354OL	2053309902	203679OL	EBJ95MBE341B	203968OL
5Q0407271AQ	203295OL	7N0407764RX	203354OL	A2053303906	203679OL	1773302300	203979OL
5Q0407763X	203295OL	7E0407271AC	203360OL	A2053304406	203679OL	A1773302300	203979OL
5QM407271E	203295OL	7E0407271R	203360OL	A2053308306	203679OL	1773302200	203980OL
7N0407761N	203295OL	7E0407451CX	203360OL	A2053309902	203679OL	A1773302200	203980OL
7N0407761NX	203295OL	7E0407276S	203361OL	1773301801	203682OL	104411900D	204027OL
7N0407763	203295OL	7E0407454AX	203361OL	A1773301801	203682OL	104416100D	204028OL
7N0407763X	203295OL	7E0407761F	203361OL	5QF407272	203683OL	104416400A	204028OL
7E0407272AR	203296OL	8K0407271AF	203371OL	5QF407272K	203683OL	1EA501204G	204092OL
7E0407272B	203296OL	8K0407271AL	203371OL	5QF407762EX	203683OL	1EA501204GX	204092OL
7E0407272P	203296OL	8K0407451JX	203371OL	5QF407762X	203683OL	1EA501203G	204093OL
7E0407272PX	203296OL	1K0407271BK	203373OL	5QF407271	203684OL	1EA501203GX	204093OL
7E0407272T	203296OL	1K0407271DQ	203373OL	5QF407271H	203684OL	31607545126	205043OL
7E0407452HX	203296OL	1K0407451GX	203373OL	8J0407761	203684OL	31607553946	205043OL
7E0407452X	203296OL	1K0407451LX	203373OL	8J0407761X	203684OL	31607622884	205043OL
1K0407272EK	203313OL	2K0407271F	203373OL	1773301500	203685OL	31607629882	205043OL
1K0407272EN	203313OL	2K0407271FX	203373OL	A1773301500	203685OL	31608631750	205043OL
1K0407272JB	203313OL	5Q0407271CB	203373OL	31607642109	203712OL	31607545125	205052OL
1K0407272PL	203313OL	5Q0407761FX	203373OL	31608643383	203712OL	31607553945	205052OL
1K0407272RB	203313OL	1K0407453HX	203380OL	31607642108	203713OL	31607622883	205052OL
1K0407272RF	203313OL	1K0407761SX	203380OL	31608657704	203713OL	31608631751	205052OL
1K0407272RR	203313OL	3C0407271AJ	203380OL	2133504602	203741OL	1643300801	205060OL
1K0407272TM	203313OL	3C0407271S	203380OL	2533509206	203741OL	1643302001	205060OL
1K0407454DX	203313OL	3C0407451AX	203380OL	A2133504602	203741OL	1643302301	205060OL
1K0407764DX	203313OL	5Q0407271AP	203380OL	A2533509206	203741OL	1643302701	205060OL
1K0407764LX	203313OL	5Q0407271BM	203380OL	2533302200	203742OL	1643302901	205060OL
1K0407764QX	203313OL	5Q0407271H	203380OL	2533305601	203742OL	1643303101	205060OL
3AA407272	203313OL	5Q0407761AX	203380OL	A2533302200	203742OL	A1643300801	205060OL
3Q0407272BD	203313OL	1K0407271LH	203381OL	A2533305601	203742OL	A1643302001	205060OL
5C0407272AA	203313OL	1K0407761JX	203381OL	2133502411	203743OL	A1643302301	205060OL
5C0407272S	203313OL	1K0407763X	203381OL	2133505000	203743OL	A1643302701	205060OL
5K0407272A	203313OL	3Q0407271AC	203381OL	2533509106	203743OL	A1643302901	205060OL
5K0407272C	203313OL	3Q0407271AD	203381OL	A2133502411	203743OL	A1643303101	205060OL
5Q0407272DD	203313OL	3Q0407271AM	203381OL	A2133505000	203743OL	1643301901	205061OL

COMPETITOR	GSP Ref.	COMPETITOR	GSP Ref.	COMPETITOR	GSP Ref.	COMPETITOR	GSP Ref.
OE		33207605486	205134OL	93453895	218445OL	A2423300100	235067OL
		33217533448	205134OL	13228199	221045OL	A2463301201	235067OL
1643302101	205061OL	33217553560	205134OL	374832	221045OL	A2463301601	235067OL
1643302401	205061OL	33217553564	205134OL	374930	221045OL	A2463301801	235067OL
1643302801	205061OL	33217561784	205134OL	375059	221045OL	A2463302001	235067OL
1643303001	205061OL	33207591595	205135OL	93169653	221045OL	A2463302301	235067OL
1643303201	205061OL	33207605485	205135OL	R1640063	221045OL	A2463302501	235067OL
A1643301901	205061OL	33207581015	205137OL	1380049	221070OL	A2463302700	235067OL
A1643302101	205061OL	33207581017	205137OL	1386970	221070OL	A2463302701	235067OL
A1643302401	205061OL	33207647027	205137OL	1457601	221070OL	A2463302900	235067OL
A1643302801	205061OL	33207581018	205139OL	1465780	221070OL	A2463303001	235067OL
A1643303001	205061OL	33204567167	205149OL	30651670	221070OL	A2463303100	235067OL
A1643303201	205061OL	33207564558	205149OL	30783201	221070OL	A2463307600	235067OL
33207597677	205066OL	33207582141	205149OL	31367526	221070OL	A2463308800	235067OL
33207597681	205066OL	1774279	218334OL	36000158	221070OL	A2463309000	235067OL
33207622853	205066OL	1774281	218334OL	36000363	221070OL	A2463309200	235067OL
33207624205	205066OL	1841533	218334OL	36011285	221070OL	A2463309400	235067OL
33207629301	205066OL	1841535	218334OL	6G9N3B437CC	221070OL	A2463309600	235067OL
33208680347	205066OL	1901270	218334OL	6G9N3B437CD	221070OL	A2463309800	235067OL
33208680351	205066OL	2009676	218334OL	7G9N3B437HA	221070OL	7L0407271	235085OL
33207597674	205067OL	2214807	218334OL	1749218	234220OL	7L0407271A	235085OL
33207597678	205067OL	2256324	218334OL	1945327	234220OL	7L0407271B	235085OL
33207597682	205067OL	2348206	218334OL	2039603	234220OL	7L0407271C	235085OL
33207622854	205067OL	2348216	218334OL	2053435	234220OL	7L0407271CX	235085OL
33207624206	205067OL	2364920	218334OL	2124797	234220OL	7L0407271D	235085OL
33207628252	205067OL	BK213B437AB	218334OL	5345951	234220OL	7L0407271E	235085OL
33207629302	205067OL	BK213B437AC	218334OL	AB393A427CA	234220OL	7L0407271EX	235085OL
33208680348	205067OL	BK213B437AD	218334OL	AB393A427CC	234220OL	7L0407271F	235085OL
33208680350	205067OL	BK213B437AE	218334OL	AB393A427DA	234220OL	7L0407271FX	235085OL
33207564128	205070OL	BK213B437BA	218334OL	EB3G3A427BB	234220OL	7L8407271	235085OL
33208603103	205070OL	BK213B437BB	218334OL	EB3G3A427CA	234220OL	7P0407271A	235085OL
33208609839	205070OL	BK213B437BC	218334OL	EB3G3A427DA	234220OL	7P0407271AX	235085OL
33207545098	205081OL	BK213B437BD	218334OL	EB3G3A427EA	234220OL	7P0407271B	235085OL
33207564126	205081OL	KK213B437AA	218334OL	UF9T2550X	234220OL	7P0407271BX	235085OL
33207564127	205081OL	KK213B437AB	218334OL	UF9T2550XB	234220OL	7P0407271C	235085OL
33208603102	205081OL	RMBK213B437A1B	218334OL	1749219	234221OL	7P0407271CX	235085OL
33208609838	205081OL	RMBK213B437B1B	218334OL	1945373	234221OL	95534903810	235085OL
A33208603102	205081OL	1774275	218335OL	2039605	234221OL	95534903811	235085OL
33207581027	205112OL	1774277	218335OL	2053156	234221OL	95534903812	235085OL
33207581029	205112OL	1841532	218335OL	2124799	234221OL	95534903813	235085OL
33207630183	205112OL	1841534	218335OL	5345953	234221OL	95834903810	235085OL
33207581028	205113OL	1901269	218335OL	AB393A428CA	234221OL	95834903811	235085OL
33207581030	205113OL	2009673	218335OL	AB393A428CC	234221OL	95834903812	235085OL
33207630184	205113OL	2214801	218335OL	EB3G3A428BA	234221OL	7L0501201A	235086OL
33207581021	205114OL	2214803	218335OL	EB3G3A428BB	234221OL	7L0501201C	235086OL
33207614289	205114OL	2323888	218335OL	EB3G3A428CA	234221OL	7L0501201CX	235086OL
33207581022	205115OL	2348193	218335OL	EB3G3A428DA	234221OL	7L8501201A	235086OL
33207614290	205115OL	2348218	218335OL	EB3G3A428EA	234221OL	7L8501201AX	235086OL
33207598031	205117OL	2364917	218335OL	UF9T2560XB	234221OL	95533202410	235086OL
33207598037	205117OL	BK213B436AB	218335OL	2423300100	235067OL	95533202411	235086OL
33207598041	205117OL	BK213B436AC	218335OL	2463301201	235067OL	1663501110	235090OL
33207598036	205119OL	BK213B436AD	218335OL	2463301601	235067OL	A1663501110	235090OL
33207598035	205120OL	BK213B436AE	218335OL	2463301801	235067OL	2053500010	235106OL
33207598032	205121OL	BK213B436BB	218335OL	2463302001	235067OL	2053509608	235106OL
33207598038	205121OL	BK213B436BC	218335OL	2463302301	235067OL	A2053500010	235106OL
33207598042	205121OL	BK213B436BD	218335OL	2463302501	235067OL	A2053509608	235106OL
31607607938	205123OL	KK213B436AA	218335OL	2463302700	235067OL	2053507608	235109OL
31607622914	205123OL	KK213B436AB	218335OL	2463302701	235067OL	2053509708	235109OL
31607629880	205123OL	RMBK213B436A1B	218335OL	2463302900	235067OL	A2053507608	235109OL
31608631746	205123OL	RMBK213B436B1B	218335OL	2463303001	235067OL	A2053509708	235109OL
33207559086	205134OL	LR024756	218408OL	2463303100	235067OL	2053502509	235119OL
33207561796	205134OL	LR031710	218409OL	2463307600	235067OL	2123502210	235119OL
33207580946	205134OL	3910000Q6M	218445OL	2463308800	235067OL	2213500002	235119OL
33207591596	205134OL	391005010R	218445OL	2463309000	235067OL	2213502010	235119OL
33207599522	205134OL	391008636R	218445OL	2463309200	235067OL	2213502810	235119OL
33207599534	205134OL	4422670	218445OL	2463309400	235067OL	2213503510	235119OL
33207604592	205134OL	6000618516	218445OL	2463309600	235067OL	2213504802	235119OL
33207604600	205134OL	8201189907	218445OL	2463309800	235067OL	221350480280	235119OL

COMPETITOR	GSP Ref.	COMPETITOR	GSP Ref.	COMPETITOR	GSP Ref.	COMPETITOR	GSP Ref.
OE		4343060060	259015OL	7E0407272AD	261084OL	1K0407271JG	261100OL
		4343060061	259015OL	7H0407271AA	261084OL	1K0407271JK	261100OL
2213505202	235119OL	4343060080	259015OL	7H0407271AF	261084OL	1K0407271LF	261100OL
A2053502509	235119OL	4343060081	259015OL	7H0407271AH	261084OL	1K0407271ME	261100OL
A2123502210	235119OL	4343060082	259015OL	7H0407271AL	261084OL	1K0407271PF	261100OL
A2213500002	235119OL	4343060090	259015OL	7H0407271AS	261084OL	1K0407453NX	261100OL
A2213502010	235119OL	4341006640	259323OL	7H0407271Q	261084OL	1K0407761RX	261100OL
A2213502810	235119OL	4341006750	259323OL	7H0407451AX	261084OL	1K0407763JX	261100OL
A2213503510	235119OL	4341006780	259323OL	7H0407451CV	261084OL	2K0407271E	261100OL
A2213504802	235119OL	4341006A10	259323OL	7H0407451CX	261084OL	2K0407271EX	261100OL
A221350480280	235119OL	4341006A40	259323OL	7H0407451DV	261084OL	2K3407271B	261100OL
A2213505202	235119OL	4341006A50	259323OL	7H0407451GX	261084OL	2K3407271BX	261100OL
3815A307	239163OL	4341006B70	259323OL	7H0407451TX	261084OL	3Q0407271AL	261100OL
3815A309	239163OL	4341006B80	259323OL	1K0407272FS	261094OL	3Q0407271N	261100OL
3815A581	239163OL	434100W180	259323OL	1K0407452QX	261094OL	3Q0407761CX	261100OL
MN107605	239163OL	4342006510	259324OL	1K0407456GV	261094OL	3Q0407761FX	261100OL
MN110547	239163OL	4342006670	259324OL	1K0407456GX	261094OL	5Q0407271BT	261100OL
3815A308	239164OL	4342006860	259324OL	1K0407766X	261094OL	5Q0407271CF	261100OL
3815A310	239164OL	4342006A60	259324OL	5K0407272F	261094OL	5Q0407271G	261100OL
3815A580	239164OL	4342006B00	259324OL	5K0407272J	261094OL	5Q0407761DX	261100OL
3815A582	239164OL	434200W210	259324OL	5K0407452AX	261094OL	5Q0407761EX	261100OL
MN110546	239164OL	4341042210	259518OL	5K0407452DX	261094OL	5Q0407761NX	261100OL
391005X20A	241262OL	4341042211	259518OL	5Q0407272EF	261094OL	5QD407271AT	261100OL
39100EB300	241262OL	5H227A684DA	259535OL	5Q0407764DX	261094OL	JZW407271X	261100OL
39100EB310	241262OL	5H227A684DC	259535OL	1K0407272BG	261096OL	7E0407271FX	261105OL
39204EB31A	241262OL	LR047295	259535OL	1K0407272CA	261096OL	7E0407271H	261105OL
1K0407272DQ	254011OL	LR072069	259535OL	1K0407272CL	261096OL	7E0407271T	261105OL
1K0407272EG	254011OL	TDB500110	259535OL	1K0407272DR	261096OL	7E0407451FX	261105OL
1K0407272ER	254011OL	4342042200	259622OL	1K0407272HK	261096OL	7E0407451LX	261105OL
1K0407272HR	254011OL	4342042201	259622OL	1K0407272HL	261096OL	7E0407451X	261105OL
1K0407272KG	254011OL	LR047292	259623OL	1K0407272HP	261096OL	7H0407271AK	261105OL
1K0407272NK	254011OL	LR047294	259623OL	1K0407272JT	261096OL	7H0407271E	261105OL
1K0407272QE	254011OL	LR071930	259623OL	1K0407272ML	261096OL	7H0407271T	261105OL
1K0407272RG	254011OL	LR072070	259623OL	1K0407272MP	261096OL	7H0407451JX	261105OL
1K0407272TQ	254011OL	TDB500080	259623OL	1K0407272NN	261096OL	7H0407451X	261105OL
1K0407454HX	254011OL	TDB500100	259623OL	1K0407272PH	261096OL	16D407272C	261147OL
1K0407454X	254011OL	434300K060	259715OL	1K0407272PJ	261096OL	1K0407272JC	261147OL
1K0407762CX	254011OL	434300K070	259715OL	1K0407272QM	261096OL	1K0407272RE	261147OL
1K0407762QX	254011OL	434300K080	259715OL	1K0407272QT	261096OL	1K0407272RS	261147OL
1K0407764BX	254011OL	1K0407272CC	261042OL	1K0407272SP	261096OL	1K0407762TX	261147OL
1K0407764PX	254011OL	1K0407272DN	261042OL	1K0407272ST	261096OL	2K0407272G	261147OL
3C0407272AK	254011OL	1K0407272EC	261042OL	1K0407452BV	261096OL	2K0407272GX	261147OL
3C0407452BX	254011OL	1K0407272FR	261042OL	1K0407452BX	261096OL	3C8407272	261147OL
1K0407271BF	254013OL	1K0407272GK	261042OL	1K0407452KX	261096OL	5N0407762F	261147OL
1K0407271BQ	254013OL	1K0407272GM	261042OL	1K0407452LX	261096OL	5N0407762FX	261147OL
1K0407271FB	254013OL	1K0407272HN	261042OL	1K0407452SX	261096OL	5N0407766B	261147OL
1K0407271HL	254013OL	1K0407272KA	261042OL	1K0407454JX	261096OL	5N0407766BX	261147OL
1K0407271KA	254013OL	1K0407272KH	261042OL	1K0407454SX	261096OL	5Q0407272CG	261147OL
1K0407271KB	254013OL	1K0407452DX	261042OL	1K0407456DX	261096OL	5QD407272BD	261147OL
1K0407271KG	254013OL	1K0407452GX	261042OL	1K0407456FX	261096OL	2H0407271B	261173OL
1K0407271KS	254013OL	1K0407452MX	261042OL	1K0407762GX	261096OL	2H0407271BX	261173OL
1K0407271LG	254013OL	1K0407454BX	261042OL	1K0407762LX	261096OL	2H0407271D	261173OL
1K0407271LK	254013OL	1K0407454PX	261042OL	1K0407764JV	261096OL	2H0407271DX	261173OL
1K0407271NT	254013OL	1K0407456CX	261042OL	1K0407764JX	261096OL	2H0407271E	261173OL
1K0407271PA	254013OL	1Q0407272	261042OL	1K0407764NX	261096OL	2H0407271EX	261173OL
1K0407451QX	254013OL	1Q0407272X	261042OL	1K0407764RX	261096OL	2H0407271F	261173OL
1K0407453CX	254013OL	2K0407272F	261042OL	1K0407764X	261096OL	2H0407271FX	261173OL
1K0407453GX	254013OL	3C0407272BS	261042OL	3C0407272AR	261096OL	2H0407271E	261173OL
1K0407761QX	254013OL	5Q0407272EX	261042OL	3C0407452CX	261096OL	1K0407271AS	261201OL
1K0407763AX	254013OL	5Q0407452CX	261042OL	5C0407272CK	261096OL	1K0407271DP	261201OL
1K0407763DX	254013OL	JZW407272DX	261042OL	5Q0407272BN	261096OL	1K0407271DS	261201OL
4410261M00	257287OL	JZW407272EX	261042OL	5Q0407272CC	261096OL	1K0407271HH	261201OL
4410261M01	257287OL	7E0407271E	261084OL	5Q0407272FG	261096OL	1K0407271HQ	261201OL
4410161MB0	257288OL	7E0407271EX	261084OL	5Q0407762BX	261096OL	1K0407271HT	261201OL
4411861MB0	257288OL	7E0407271J	261084OL	5Q0407762X	261096OL	1K0407271JA	261201OL
4411961MB0	257288OL	7E0407271Q	261084OL	JZW407272AX	261096OL	1K0407271JF	261201OL
4343004070	259015OL	7E0407271S	261084OL	JZW407272CX	261096OL	1K0407271KP	261201OL
4343004071	259015OL	7E0407271SX	261084OL	16D407271C	261100OL	1K0407271LA	261201OL

COMPETITOR	GSP Ref.	COMPETITOR	GSP Ref.	COMPETITOR	GSP Ref.	COMPETITOR	GSP Ref.
OE		1K0407764KX	261283OL	36001532	262084OL		
		3Q0407272BR	261283OL	36002066	262084OL		
1K0407451HV	261201OL	3Q0407762MX	261283OL	30651671	262086OL		
1K0407451HX	261201OL	5Q0407272DB	261283OL	31272548	262086OL		
1K0407451NV	261201OL	5Q0407272FF	261283OL	31367543	262086OL		
1K0407451NX	261201OL	5Q0407272H	261283OL	36000162	262086OL		
1K0407761AX	261201OL	5Q0407762EX	261283OL	36000368	262086OL		
1K0407761DX	261201OL	5Q0407762LX	261283OL	36001194	262086OL		
1K0407761EX	261201OL	1Q0407271B	261285OL	36011296	262086OL		
1K0407761MV	261201OL	5Q0407271BL	261285OL	6G9N3B436CE	262086OL		
1K0407761MX	261201OL	5Q0407271BQ	261285OL	P31272548	262086OL		
1K0407761NV	261201OL	5Q0407271L	261285OL	31325117	262117OL		
1K0407761NX	261201OL	5Q0407271M	261285OL	31437521	262117OL		
1K0407763CX	261201OL	5Q0407761CX	261285OL	36010062	262117OL		
1K0407763GX	261201OL	5Q0407761LV	261285OL	36010215	262117OL		
3C0407271AB	261201OL	5Q0407761LX	261285OL	31325116	262119OL		
3C0407271AC	261201OL	5Q0407761MV	261285OL	36010060	262119OL		
3C0407451X	261201OL	5Q0407761MX	261285OL	1380034	299211OL		
3Q0407271AR	261201OL	5Q0407761X	261285OL	1417222	299211OL		
3Q0407271AS	261201OL	5N0407761Q	261296OL	1424195	299211OL		
3Q0407271D	261201OL	5N0407761QX	261296OL	1431396	299211OL		
3Q0407761DX	261201OL	5N0407761S	261296OL	1437736	299211OL		
3Q0407761EV	261201OL	5N0407761SX	261296OL	1667774	299211OL		
3Q0407761EX	261201OL	5N0407763	261296OL	1788208	299211OL		
1K0407272DT	261211OL	5N0407763A	261296OL	1840157	299211OL		
1K0407272HB	261211OL	5N0407763AX	261296OL	36002892	299211OL		
1K0407272KC	261211OL	5N0407763K	261296OL	6G913B437BA	299211OL		
1K0407272MF	261211OL	5N0407763X	261296OL	6G913B437BB	299211OL		
1K0407452CX	261211OL	JZW407271FX	261296OL	6G913B437BC	299211OL		
1K0407452NX	261211OL	5Q0407272B	261307OL	6G913B437BD	299211OL		
1K0407762X	261211OL	5Q0407272C	261307OL	6G913B437BE	299211OL		
7L0501201B	261236OL	5Q0407762CX	261307OL	6G913B437BF	299211OL		
7L0501201BX	261236OL	5Q0407762DX	261307OL	RM6G913B437B2F	299211OL		
95533202400	261236OL	95B501203	261338OL				
95533202401	261236OL	95B501203A	261338OL				
7E0501201B	261257OL	95B501203E	261338OL				
7E0501201BX	261257OL	95B501203G	261338OL				
7E0501201C	261257OL	95B501203H	261338OL				
7E0501201CX	261257OL	95B501203M	261338OL				
7H0501201C	261257OL	95B501203R	261338OL				
7H0501201CX	261257OL	1K0407272LF	261341OL				
7H0501201D	261257OL	1K0407456AX	261341OL				
7H0501201DX	261257OL	2K0407272E	261341OL				
7E0501202	261258OL	2K0407272EX	261341OL				
7E0501202X	261258OL	3Q0407272AB	261341OL				
7H0501202B	261258OL	3Q0407272C	261341OL				
7H0501202BX	261258OL	3Q0407762DX	261341OL				
7H0501202C	261258OL	3Q0407762LX	261341OL				
7H0501202CX	261258OL	5C0407272AC	261341OL				
7H0501202D	261258OL	5Q0407272CF	261341OL				
7H0501202DX	261258OL	5Q0407272DR	261341OL				
1K0407271JJ	261281OL	8J0407272H	261341OL				
1K0407761PX	261281OL	8J0407272T	261341OL				
1K0407763BX	261281OL	8J0407452AX	261341OL				
5C0407271R	261281OL	JZW407272X	261341OL				
8J0407271G	261281OL	3Q0407272AT	261345OL				
8J0407271GX	261281OL	3Q0407762HX	261345OL				
8J0407761C	261281OL	561407272S	261345OL				
1K0407271LB	261282OL	3Q0407272BG	261347OL				
1K0407763KX	261282OL	5N0407764L	261347OL				
5Q0407271A	261282OL	5N0407764T	261347OL				
5Q0407271BP	261282OL	5N0407764TX	261347OL				
5Q0407271BR	261282OL	5N0407766	261347OL				
5Q0407451X	261282OL	5N0407766D	261347OL				
5Q0407761JX	261282OL	5N0407766DX	261347OL				
1K0407272BJ	261283OL	5N0407766X	261347OL				
1K0407272QN	261283OL	31259623	262084OL				
1K0407272QS	261283OL	31367067	262084OL				

New applications (compared with catalogue 2023)

GSP Ref.	GSP Ref.	GSP Ref.	GSP Ref.	GSP Ref.	GSP Ref.
201110OL	218335OL				
201666OL	218445OL				
201698OL	221045OL				
201699OL	221070OL				
201700OL	235090OL				
201701OL	235106OL				
201702OL	235109OL				
202075OL	235119OL				
202256OL	259323OL				
202345OL	259324OL				
202346OL	261257OL				
202356OL	261258OL				
202363OL	262084OL				
202548OL	262086OL				
202855OL	262117OL				
202856OL	262119OL				
203102OL	299211OL				
203103OL					
203138OL					
203139OL					
203207OL					
203208OL					
203231OL					
203273OL					
203296OL					
203405OL					
203406OL					
203496OL					
203497OL					
203613OL					
203640OL					
203661OL					
203679OL					
203682OL					
203683OL					
203684OL					
203685OL					
203712OL					
203713OL					
203741OL					
203742OL					
203743OL					
203782OL					
203784OL					
203925OL					
203935OL					
203936OL					
203937OL					
203938OL					
203968OL					
203979OL					
203980OL					
204027OL					
204028OL					
204092OL					
204093OL					
218334OL					



GSP Group Headquarter

No.1 GaoXiang Road, Wenzhou, China
Tel: 86-577-8629-3120
Email: internationalsales@gsp.cn

GSP Germany Cologne (Business Center)

Leyboldstrasse 10, 50354 Huerth, Germany
Tel: 49-223-3808-8418
Fax: 49-223-1941-0282
Email: info@gsp-europe.com

GSP Germany Hamburg (Distribution Center)

Werkstrasse 1, 22844 Norderstedt, Germany
Tel: 49-406-4669-9460
Email: gsp@elbex-hamburg.de

GSP Poland Gdansk (Distribution Center)

Elbląska 130, 80-718 Gdańsk, Poland

GSP N.A South Carolina (Business Center / Distribution Center)

2725 New Cut Road, Spartanburg, SC 29303, USA
Tel: 1-864-578-6900
Fax: 1-864-578-6978
Email: info@gsp-na.com

GSP N.A Arizona (Business Center / Distribution Center)

950 N. 119th Ave. Suite 100, Avondale, AZ 85323, USA
Tel: 1-480-418-3405
Fax: 1-562-376-8550
Email: info@gsp-na.com

GSP L.A. Florida (Business Center)

2600 S. Douglas Rd., PH 10, Coral Gables, FL 33134, USA
Tel: 1-305-446-7702
Email: info@gsplatinamerica.com

GSP Mexico Queretaro (Business Center)

Manuel Gomez Morin, No EXT. 3960, PISO 1 OFICINA 1D,
Centro Sur. Queretaro, C.P.: 76090
Tel: 52-442-2449414
Email: info@gsplatinamerica.com

GSP Mexico Queretaro (Distribution Center)

Privada del marqués lote 4a1 bodegas 6, 7 y 8, IV sección,
Parque Industrial Querétaro, CP. 76226

GSP Malaysia Johor (Manufacturing Center)

No. 18 (PLO 36), Jalan Teknologi 4, Taman Teknologi Johor,
81400 Senai, Johor, Malaysia
Tel: 86-577-86293120
Email: internationalsales@gsp.cn



LinkedIn
GSP Automotive Group



Facebook
GSP Automotive Group



Youtube
GSP Automotive Group



Instagram
gsp_automotive_group